



PETROL BRUSH CUTTER & GRASS TRIMMER

RACD314TB-A

INSTRUCTION MANUAL

CAUTION: Read the instructions before using the machine !

CONTENTS

1. SAFETY INSTRUCTIONS.....	3
2. YOUR PRODUCT.....	8
3. TECHNICAL DATA.....	8
4. ASSEMBLY.....	9
5. FILLING OIL TANK AND FUEL TANK.....	12
6. OPERATION.....	13
7. MAINTENANCE AND STORAGE.....	15
8. DECLARATION OF CONFORMITY.....	17
9. WARRANTY.....	18
10. PRODUCT FAILURE.....	19
11. WARRANTY EXCLUSIONS.....	20

1. SAFETY INSTRUCTIONS

Proper safety precautions must be observed. Like all power equipment this unit must be handled carefully. **DO NOT EXPOSE YOURSELF OR OTHERS TO DANGER.**

Follow these general rules. Do not permit others to use this machine unless they are thoroughly responsible and have read and understand the machine manual and are trained in its operation.

- For machines with a clutch, routines for checking that the cutting attachment stops turning when the engine idles.
- Always wear safety goggles for eye protection. Dress properly; do not wear loose clothing or jewelry that could become caught in moving parts of the unit. Safe, sturdy, nonskid footwear should always be worn. Long hair should be tied back. It is recommended that legs and feet be covered to protect from flying debris during operation.
- Inspect the entire machine for loose parts (nuts, bolts, screws, etc.) and any damage. Repair or replace as necessary before using the machine. **DO NOT USE** any attachment with this power head other than the ones recommended by our company. Serious injury to the operator or bystanders could result as well as damage to the machine.
- Keep the handles free from oil and fuel.
- Always use proper handles and shoulder strap when cutting.
- Do not smoke while mixing fuel or filling tank.
- Do not mix fuel in an enclosed room or near open flames. Assure adequate ventilation.
- Always mix and store the fuel in a properly marked container that is approved by local codes and ordinances for such usage.
- Never remove the fuel tank cap while the engine is running.
- Never start or run the engine inside a closed room or building. Fumes from the exhaust contain dangerous carbon monoxide.
- Never attempt to make engine adjustments while the unit is running and strapped to the operator. Always make engine adjustments with the unit resting on a flat, clear surface.
- Do not use the unit if it is damaged or poorly adjusted. Never remove the machine's guard. Serious injury to the operator or bystanders could result as well as damage to the machine.
- Inspect the area to be cut and remove all debris that could become entangled in the nylon cutting head. Also remove any objects that the unit may throw during cutting.
- Keep children away. Onlookers should be kept at a safe distance from the work area, at least 15 meters.
- Never leave the machine unattended.
- Do not use this unit for any job other than those for which it is intended as described in this manual.
- Do not overreach. Always keep proper footing and balance. Do not run the unit while standing on a ladder or on any other unstable footing location.
- Keep hands and feet clear of the nylon cutting head or blade while unit is in use.
- Do not use this type of machine for sweeping away debris.
- Do not use the unit when you are tired, ill or under the influence of medication, drugs, or alcohol.
- Use nylon cutting head which is free of damage. If a stone or any other obstacle is hit, stop the engine, and check the nylon cutting head. A broken or unbalanced nylon cutting head must never be used.
- Do not store in a closed area where fuel vapors can reach an open flame from hot water heaters, furnaces, etc. Store in a locked, well-ventilated area only.
- Ensure safe and proper performance of your product. These parts are available from your dealer. The use of any other accessories or attachments may cause a potential hazard or injury to the user, damage to the machine and void this warranty.
- Clean the machine completely, especially, the fuel tank, its surroundings, and the air cleaner.
- When refueling, be sure to stop the engine and confirm that it is cooled down... Never refuel when the

engine is running or hot. When gasoline spills, be sure to wipe it up completely dispose of those materials before starting the engine.















- Stay clear of other workers or bystanders by at least 15 meters/50 feet.
- Whenever approaching an operator of the machine, carefully call his attention and confirm that the operator stops the engine. Be careful not to startle or distract the operator which can cause an unsafe situation.
- Never touch the nylon cutting head or blade whenever the engine is running. If it is necessary to replace the protector or cutting attachment, be sure to stop the engine and confirm that the cutting device has stopped running.
- The engine should be turned off when the machine is moved between work areas.
- Be careful not to hit the nylon cutting head against stones, or the ground.
- Unreasonable rough operation will shorten the life of the machine as well as create an unsafe environment for yourself and those around you.
- Pay attention to loosening and overheating of parts. If there is any abnormality of the machine, stop operation immediately and check the machine carefully. If necessary, have the machine serviced by an authorized dealer. Never continue to operate a machine which may be malfunctioning.
- In start-up or during operation of the engine, never touch hot parts such as the muffler, the high voltage wire, or the spark plug.
- After the engine has stopped, the muffler is still hot. Never place the machine in any places where there are flammable materials (dry grass, etc.), combustible gasses or combustible liquids.
- Pay special attention to operation in the rain or just after the rain as the ground may be slippery.
- If you slip or fall to the ground or into a hole, release the throttle lever immediately.
- Be careful not to drop the machine or hit it against obstacles.
- Before proceeding to adjust or repair the machine, be sure to stop the engine and detach the spark plug.
- When the machine is placed in storage for a long time, drain fuel from the fuel tank and carburetor, clean the parts, move the machine to a safe place and confirm that the engine is cooled down.
- Make periodic inspections to assure safe and efficient operation. For a thorough inspection of your machine, please contact a dealer.
- Keep the machine away from fire or sparks.
- It is believed that a condition called Raynaud's phenomenon, which affects the fingers of certain individuals, may be brought about by exposure to vibration and cold. Loss of color and numbness in the fingers. The following precautions are strongly recommended because the minimum exposure which might trigger the ailment is unknown.
- Keep your body warm, especially the head, neck, feet, ankles, hands, and wrists.
- Maintain good blood circulation by performing vigorous arm exercises during frequent work breaks and by not smoking.
- Limit the hours of operation. Try to fill each day with jobs where operating the brush cutter or other hand-held power equipment is not required.
- If you experience discomfort, redness and swelling of the fingers followed by whitening and loss of feeling, consult your physician before further exposing yourself to cold and vibration.
- Always wear ear protection, loud noise for long time can make hearing debase even lost hearing.
- Total face and head protection must be wearing to prevent damage from plummet or branch.
- Wear no-slip heavy duty work gloves to improve your grip on the brush cutter handle. Gloves also reduce the transmission of machine vibration to your hands.
- **WARNING:** The cutter area is still dangerous while the machine is coasting to a stop.
- When transport, this unit must be handled carefully. Do not expose yourself or others to danger.
- Envelop the blade before storage. Keep children away from it.
- Never remove the machine's guard.





- Do not store in a closed area where fuel vapors can reach an open flame from hot water heaters, furnaces, etc. Store in a locked, well-ventilated area only.
- Never place the machine in any places where there are flammable materials (dry grass, etc.), combustible gasses or combustible liquids.
- When the machine is placed in storage for a long time, drain fuel from the fuel tank and carburetor, clean the parts, move the machine to a safe place and confirm that the engine is cooled down.
- Warning: Emission of exhaust gases; do not inhale them since these gases is dangerous for health.
- National regulation can restrict the use of the machine.
- Never modify a cutting element in any way.
- Improper use of the machine can cause SERIOUS OR FATAL PERSONAL INJURY.
- The engine exhaust form this product contains chemicals to cause cancer, birth defects, of other reproductive harm.
- Checking regularly that the cutting attachment stops turning when the engine idles.
- Use recommended cutting attachments and appropriate. Contact your dealer or our service agent to know which cutting attachment can be used with this tool. There are possible safety consequences from using other cutting attachments, e.g., metal multi-piece pivoting chains and flail blades.
- Check each time before and after use, after a fall or other impacts to identify any significant damage.
- Do not use the tool in case of damage. Bring it to a qualified service agent for inspection and reparation.
- Risks and problems may occur during the operation, follow the instructions in this manual to reduce these risks:
- If the machine or cutting attachment needs to be unlocked, stop using the tool, remove the spark plug. Wear safety protection to unlock the tool.
- Do not work prolonged with the tool, take regular breaks during the operation.
- Always keep a correct posture, do not use the tool in a position that could create accidents.
- Secure the machine during transport to prevent loss of fuel, damage or injury. Always put the protection devices on the blades. Always transport the tool upright.
- Put the protection on the blade when storing the tool.
- Hazards which could be encountered while using the machine (bump a foreign object, blockage of the cutting attachment, etc.). To avoid hazards, inspect thoroughly the working area; remove all hazardous material and object which may be present.

Kickback and Related Warnings

- Kickback is a sudden reaction to a pinched or snagged rotating wheel, backing pad, brush or any other accessory. Pinching or snagging causes rapid stalling of the rotating accessory which in turn causes the uncontrolled power tool to be forced in the direction opposite of the accessory's rotation at the point of the binding.
 - For example, if an abrasive wheel is snagged or pinched by the workpiece, the edge of the wheel that is entering into the pinch point can dig into the surface of the material causing the wheel to climb out or kick out. The wheel may either jump toward or away from the operator, depending on direction of the wheel's movement at the point of pinching. Abrasive wheels may also break under these conditions.
 - Kickback is the result of power tool misuse and/or incorrect operating procedures or conditions and can be avoided by taking proper precautions as given below.
- a) Never place your hand near the rotating accessory. Accessory may kickback over your hand.
 - b) Do not position your body in the area where power tool will move if kickback occurs. Kickback will propel the tool in direction opposite to the wheel's movement at the point of snagging.
 - c) Use special care when working corners, sharp edges etc. Avoid bouncing and snagging the accessory. Corners, sharp edges or bouncing have a tendency to snag the rotating accessory and cause loss of control or kickback.

Explanation of symbols

	Warning symbol.
	Read instructions manual.
	Wear protective equipment: hearing protection, eye protection, and helmet.
	Wear protection gloves.
	Wear protective footwear.
	Caution to exhaust gases.
	Do not expose to rain.
	Do not smoke and use the tool near naked flame.
	The accessible part are hot when operate the tool.
	Caution! Risk of rebound.
	Keep bystanders away at least 15m.
	Warning - Risk of projection.
	After the machine stops, the impact attachment continues to rotate. You must wait for it to come to a complete stop. Before performing any maintenance or intervention on the machine, disconnect the spark plug. Read the instruction manual.
	Caution! The tool can contact to a voluminous material. Loss of control and injuries can be created.

	Warning! Cutting elements.
	Cutting attachment speed.
	Cutting attachment speed.
	Guarantee sound power level.
	Do not use saw blades.

Residual risks

Even if you use this tool correctly, there are always residual risks. The following hazards may arise in connection with the structure and manufacture of this power tool:

- Hearing impairment if no suitable hearing protection is worn.
- Cuts if no suitable protective clothing is worn.
- Health damage resulting from vibration in the hands and arms if the device is used for a long period of time or is not handled and maintained properly.
- Inhalation of particles
- Inhalation of exhaust gases
- Skin contact with oil / gasoline
- Inhalation of gasoline / oil vapors
- Contact with projected objects
- Burns when touching with hot surfaces
- Prolonged use of this product exposes the operator to vibration and can produce so-called "white finger" disease. To reduce the risk, wear gloves and keep your hands warm.
- If any of the symptoms of "white finger syndrome" occur, seek immediate medical attention. Symptoms of the "white finger" include numbness, loss of sensitivity, tingling, pain, loss of strength, color changes or skin condition. These symptoms usually appear on the fingers, hands or wrists. Risk increases at low temperatures.

Intended use

This machine can be used with the cutting wire as a trimmer for cutting grass and weeds of small thickness and in small quantity and with the cutting blade as a brush cutter for cutting denser vegetation. This machine must not be used for cutting or other cutting operations where the cutting tool must be lifted above the ground. This machine is only authorized for private use. Any other use or modification of this machine is prohibited and involves high risks.

2. YOUR PRODUCT

a. Description

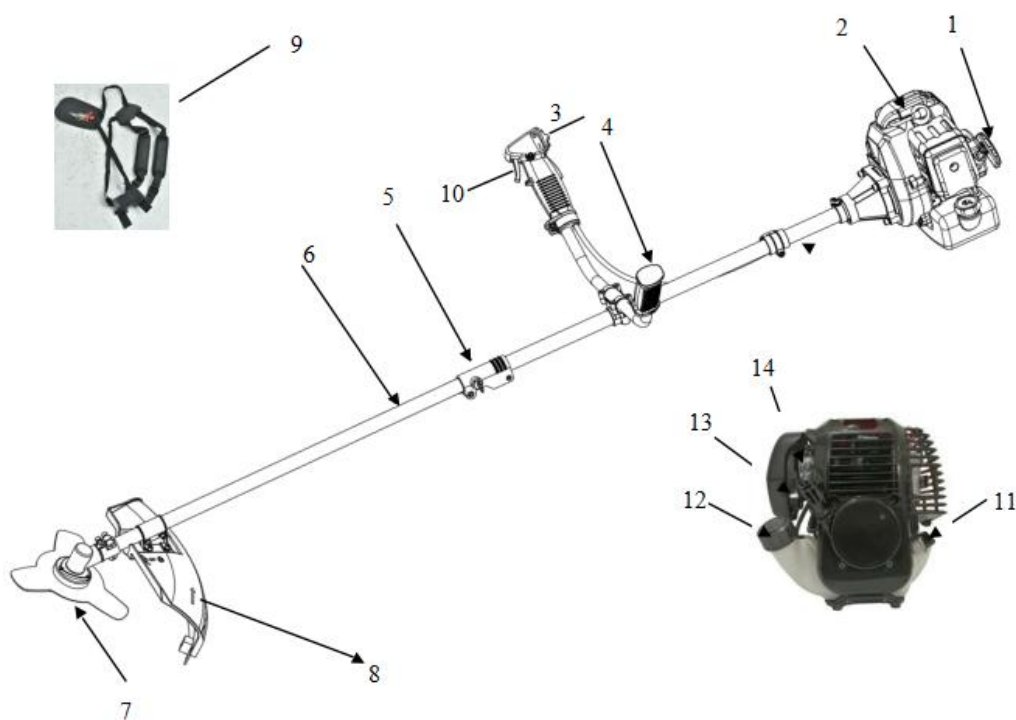

1.	Recoil starter handle	8.	Shield
2.	Spark plug	9.	Shoulder strap
3.	ON/OFF switch	10.	Throttle trigger
4.	Handlebar	11.	Oil dipstick
5.	Coupler	12.	Fuel tank
6.	Shaft	13.	Choke lever
7.	Blade	14.	Primer bulb

3. TECHNICAL DATA

Engine displacement	31cm ³
Maximum rotational frequency of the spindle	9500/min
Maximum power	0,8kW / 6500/min
Mass	9,5 kg
Volume of fuel tank	850 ml
Volume of oil tank	80 ml
Cutting diameter	Grass trimmer: 430mm Brushcutter: 255mm
Cutting thickness	Brushcutter: 1,4mm (3 teethes metal blade) Grass trimmer: 2,4mm (non-metallic flexible line)
Cutting teeth	Brushcutter: single piece (three teeth metal) Grass trimmer: 2 lines (non-metallic flexible line)
Blade center hole diameter	25,4mm (metal blade)
Maximum rotational frequency of the spindle	Brushcutter: 6900min ⁻¹ Grass trimmer: 6300min ⁻¹
Cutting blade	TOPWE, 10000/min

Cutting string head	TOPWE, 10000/min
Gear ratio	4:3
Engine	139F
Idling speed	3000/min
Measured vibration emission value	<u>Brush cutter:</u> Max: 7,912m/s ² K=1.5 m/s ² <u>Grass trimmer:</u> Max: 8,254 m/s ² , K=1.5 m/s ²
Measured sound pressure level LpA	<u>Brush cutter:</u> Idling: 82.2dB(A) K= 3dB(A) Racing: 102,4 dB(A) K= 3dB(A) <u>Grass trimmer:</u> Idling: 92.1dB(A) K= 3dB(A) Racing: 107.6dB(A) K= 3dB(A)
Measured sound power level LwA	Brush cutter: 107.4dB(A) K= 3dB(A) Grass trimmer: 108.2dB(A) K= 3dB(A)
Guaranteed sound power level	112dB(A)

4. ASSEMBLY

a) Installation of the tube on the tool

- Pull the tap (1) and insert the tube on the tool (2). Make sure to fix the pin into the hole of the tube (the tool must be locked).
- Screw the bolt to fix the tool (3).

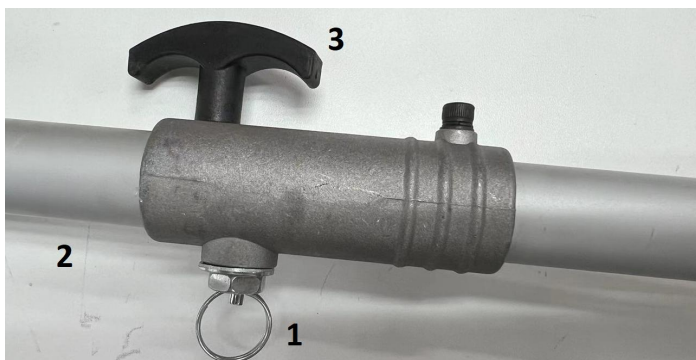

b) Installation of the handle

- Unscrew the bracket and remove it (Fig 4).
- Install the handle in the bracket at the desired position (Fig 5).
- Reinstall the bracket and screw it with the 4 screws (Fig 6).

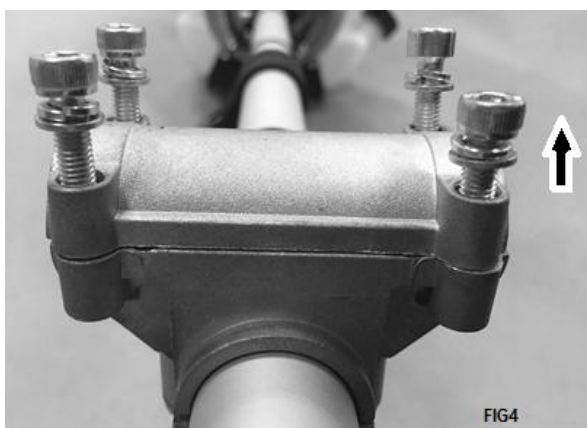

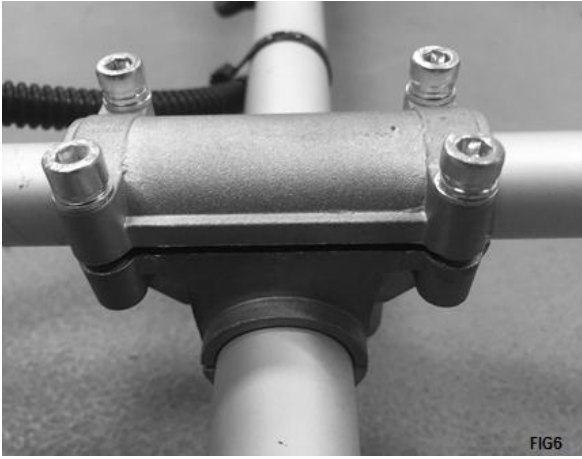

c) Installation of the carter of protection

- Place the carter on the shaft; be sure that the position is correct (see below picture).
- Screw the carter with the 4 provided screws.



d) Installation of the nylon cutting head (for grass trimmer operation)

- Insert a metal locking tool into the hole on the side of the drive gear and on the tool drive.
- Remove the holding nut, the cover bell, and the plate from the shaft.
- Install and screw the nylon cutting head.
- Remove then the metal locking tool.



To disassemble the cutting head, insert a metal locking tool through the hole on the side of the drive sprocket and on the drive shaft. Unscrew the cutting head to remove it.

e) Installation of metal blade (for brush cutter operation)

- Insert a metal locking tool into the hole on the side of the drive gear and on the tool drive.
- Remove the holding nut, the cover bell, and the plate from the shaft.
- Install, in the following order, on the shaft: the blade, the plate, the cover bell and then the holding nut.
- Remove the metal locking tool.



To remove the blade, insert a metal locking tool through the hole on the side of the drive sprocket and on the drive shaft. Loosen the clamp nut, then remove all parts.

NOTE

After installation, always check if the installation is correct. If blade is not well installed, it will vibrate excessively and can cause injury. When operation, if there is abnormal vibration, immediately stop the tool and check the installation.

Installation of the harness

- Put on the harness.
- If necessary, adjust the bands of the harness to have the blade parallel to the ground when standing in your normal working position to provide you most effectiveness and comfort on operating the machine.
- Install the hook on the main unit to attach the harness.

Quick release mechanism

Pull the strip to release the machine from you in the case of emergency.

5. FILLING OIL TANK AND FUEL TANK

a) Fuel

- **Warning: Gasoline is highly flammable. Keep the fuel in specially designed cans.**
- **Only fill the tank outside and do not smoke during the operation. Avoid sparks or open flames near the fuel.**
- **Fill the tank before starting the engine. Never remove the fuel tank cap, add fuel while the engine is still running, or while the engine is still warm.**
- **Avoid overfilling the tank: When excess fuel has escaped, do not attempt to start the engine, but move the machine away and avoid any sources of ignition in the vicinity until the fuel vapors have dissipated.**
- **Fully tighten all fuel filler caps and cans.**
- **Fill the tank on the floor.**
- **The engine must be started at a distance of at least 3 meters from where the fuel tank has been filled.**
- **Switch off the engine before adding fuel. Shake the mixture thoroughly before filling the tank.**
- **Store gasoline in tanks specially designed for this purpose.**
- **Fill the fuel tank of your appliance outdoors and avoid smoking during work.**
- **Fill the tank before starting the engine. Never open the fuel tank cap or fill fuel tank while the engine is running, or the engine is still hot.**
- **Avoid spilling gasoline: When gasoline is spilled, do not start the machine, and move it away from where the gasoline has spilled to avoid possible sources of fire.**
- **Screw all caps and tank cover carefully.**

This type of tool is designed to be used with unleaded gasoline. Using unleaded gasoline prevents unnecessary pollution in the interests of your health and the protection of the environment. Using gasoline or oil of lesser quality can damage seal rings, ducts, or fuel tank.

Exhaust emissions are regulated by the basic technical characteristics of the engine and its components (carburation, adjustment of spark plugs, control of exhaust opening and closing times) in the absence of accessories or a catalyst during combustion.

Filling the tank

- Unscrew the tank cap.
- Fill the tank to 80% of its capacity.

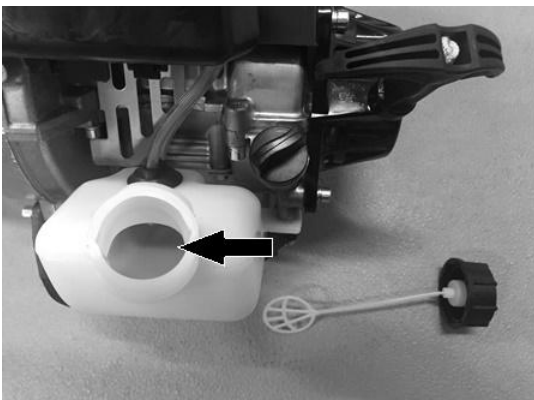

- Screw the fuel cap back on. Clean the fuel tank cap and the area around after filling the fuel tank. Eliminate overfill of fuel mixture by rubbing.

b) Oil

- Open the oil tank.

- Pour the oil in the tank. Do not overfill.

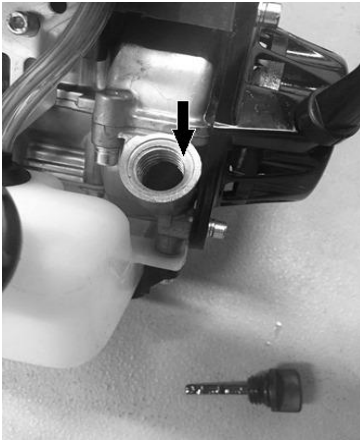

- Close the tank. Wipe off all overfill oil.

Information

Recommended oil: We recommend the use of high-quality detergent oil classified for SF, SG, SH, SJ or higher. Do not use special additives.

External temperatures determine the correct oil viscosity for the engine.

Below 4°C, the use of SAE 30 oil causes difficult start-ups.

Above 27°C, the use of 10W-30 oil can increase the oil consumption. Check the oil level regularly.

Checking the oil level

- The tool must be switch off.
- Remove the dipstick from the oil tank and wipe it off.
- Insert the oil tank dipstick into the tank, without screwing it in, and then remove it to check the oil level.
- If the oil level is near or below the lower limit of the dipstick, remove the dipstick and refill the oil tank until the upper limit of the dipstick (bottom edge of the dipstick). Do not overfill.
- Replace the oil tank dipstick.

6. OPERATION

a) Starting the tool

■ Cold starting

- Switch on the tool by putting the Start/stop button on the position I (ON).
- Push the primer bulb 7-10 times, until fuel comes into the primer bulb.

- Pull the choke lever to the close position.



- Pull the starter cord until the engine starts.

- Pull the choke lever to the open position.



- Allow engine to warm up for a few minutes before using.
- Push the safety switch then the throttle trigger to start the operation.

■ Hot starting

The warm starting can be done when the tool was switched off but still hot.

- Switch on the tool by putting the ON/OFF button on the position I (ON).
- Push the primer bulb 7-10 times, until fuel comes into the primer bulb.

- The choke lever must be kept in the open position.  . If it is not the case, restart the machine by performing a cold starting.
- Pull the starter cord until the engine starts.
- Allow engine to warm up for a few minutes before using.
- Push the safety switch then the throttle trigger to start the operation

b) Stopping the tool

- Release the throttle trigger and the throttle trigger lockout.
- Let the tool run for a few minutes.
- Move the ON/OFF switch to STOP position (O).

c) Grass trimmer operation

- Trimming

Tilt the head slowly to direct debris away from you. If cutting up to a barrier such as fence, wall or tree, approach from an angle where any debris ricocheting off the barrier will fly away from you, Move the line head slowly until the grass is cut right up the barrier, but do not jam (overfeed) the line into the barrier. If trimming up to a wire mesh or chain linked fence be careful to feed only up to wire. If you go too far the line will snap off around the wire. Trimming can be done to cut through weed stems one at a time. Place the trimmer line head near the bottom of the weed-never high up which could cause the weed to chatter and catch the line. Rather than cut the weed right through, just use the very end of the line to wear through the stem slowly.

- Scalping and edging

Both are done with the line head tilted at a steep angle Scalping is removing top growth leaving the earth bear.

Edging is trimming the grass back where it has spread over a sidewalk or driveway. During both edging and scalping, hold the unit a steep angle and in a position where the debris, and any dislodging dirt and stones, will not come back towards you even if it ricochets off the hard surface. Although the picture shows how to edge and scalp every operator must find for himself the angles which suits his body size and cutting situation.

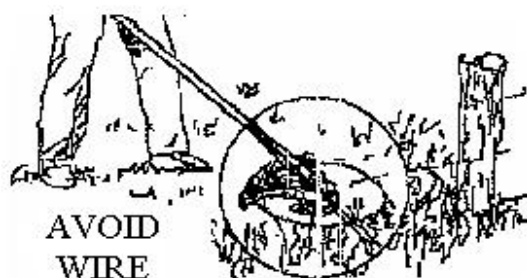
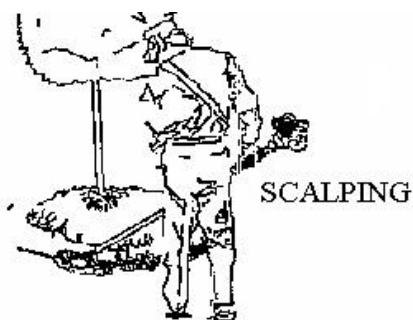

d) **Brushcutter operation**

- Do not use the brushcutter for cutting trees
- Do not cut with dull, cracked or damaged metal blade.
- Before cutting growth, inspect for obstructions such as boulders, metal stakes or strands of wire from broken fences. If an obstruction cannot be removed, mark its location so that you can avoid it with the blade. Rocks and metal will dull or damage a blade. Wire can catch on the blade head and flap around or be thrown into the air.
- Always use the shoulder harness, adjust both harness and harness clamp on the unit so that the unit hangs a few inches above ground level. The cutting head and the debris shield should be level in all directions. Harness the unit on the right side of your body.
- Cut only with the side of the blade that the debris is moving away from you.
- If kickback occurs, the blade may be dull, or the material so thick and hard that you should use another tool instead of this machine.
- Do not force the blade to cut. Do not change the angle of cut after it enters the wood. Avoid using any pressure or leverage which could cause the blade to bind or crack.

Scything weeds

This is cutting by swinging the blade in a level arc. It can quickly clear areas of field grass and weeds. Scything should not be used to cut large, tough weeds or woody growths.

Scything can be done in both directions, or just in one way which results in the debris being thrown away from you.

That is using the side of the blade that it is rotating away from you. Tilt down the blade slightly on this same side. You will be hit by some debris if you scythe in both directions.

7. MAINTENANCE AND STORAGE

After each use, clean and maintain the tool; look for loose fasteners, fuel leaks and damaged parts, such as cracks in cutting attachments. Keep the machine in good working order.

a) **Air filter**

- Accumulated dust in the air filter will reduce engine efficiency. Increase fuel consumption and allow abrasive particles to pass into the engine. Remove the air filter as often as necessary to maintain in a clean condition. Light surface dust can readily be removed by tapping the filter. Heavy deposits should be washed out in suitable solvent.
- Press the tab to unlock the lid.
- Remove the filter to clean it.
- After cleaning and drying, replace the filter and then replace the cover.

b) **Adjusting the carburetor**

Do not adjust carburetor unless necessary. If you have trouble with the carburetor, see your dealer. Improper adjustment may cause engine damage and void warranty.

c) **Fuel filter**

Fuel tank is fitted with a filter. Filter is situated at the free end of fuel pipe and can be picked out through fuel port with a piece of hooked wire. Check the fuel filter periodically. Do not allow dust to enter in the fuel tank. Clogged filter will cause difficulty in starting engine or abnormalities in starting engine or abnormalities in engine performance.

When filter is dirty, replace the filter. When the inside of the fuel tank is dirty, it can be cleaned by rinsing the tank out with gasoline.

d) **Spark plug**

Do not attempt to remove the plug from a hot engine to avoid possible damage to the threads.

- Clean or replace the spark plug in case of ozone contamination.

- Replace the spark plug if the end of the center electrode is worn.

e) Handling and transport

- The engine should be turned off when the unit is moved between work areas.
- After the engine has stopped, the muffler is still hot. Never touch hot parts such as the muffler.
- Confirm that the fuel is not leaked from tank.
- Transport the tool in a way to prevent loss of fuel, injuries, and damage.
- Dismantle the cutting head and the blade before transport and storage. Put the blade in its packing.

f) Storage

- Inspect, clean, and have the appliance repaired if necessary
- Empty the tank.
Switch on the appliance to consume all remaining fuel.
- Remove the spark plug and pour a teaspoon of clean engine oil into the cylinder cavity of the spark plug, replace the spark plug
- Store cutting elements so that they cannot be touched (wrap them, for example.)
- Store in a clean, dry, dust-free area.

8. DECLARATION OF CONFORMITY



BUILDER SAS

ZI, 32, rue Aristide Bergès – 31270 Cugnaux - France

Tel: +33 (0)5.34.502.502 Fax: +33 (0)5.34.502.503

declares that the machine:

**PETROL BRUSH CUTTER & GRASS TRIMMER
RACD314TB-A**

Serial No: 20230905471-20230905935

the people name holding the technical file: Mr. Olivier Patriarca

have been designed in compliance with the following standards:

EN ISO 11806-1:2022

EN ISO 14982:2009

And in accordance with the following directives:

Directive Machine 2006/42/EC

Directive EMC 2014/30/EU

RoHS Directive (EU)2015/863 amending 2011/65/EU

Emission directive (EU) 2016/1628

Noise Directive 2000/14/EC Annex V & Directive 2005/88/EC

Measured sound power level L_{WA}

Brush cutter: 107.4dB(A) K= 3dB(A)

Grass trimmer: 108.2dB(A) K= 3dB(A)

Guaranteed sound power level: 112dB(A)

Cugnaux, 04-09-2023

Philippe MARIE / PDG

9. WARRANTY



WARRANTY

The manufacturer guarantees the product against defects in material and workmanship for a period of 2 years from the date of the original purchase. The warranty only applies if the product is for household use. The warranty does not cover breakdowns due to normal wear and tear.

The manufacturer agrees to replace parts identified as defective by the designated distributor. The manufacturer does not accept responsibility for the replacement of the machine, in whole or in part, and/or ensuing damage.

The warranty does not cover breakdowns due to:

- insufficient maintenance.
- abnormal assembly, adjustment or operations of the product.
- parts subject to normal wear and tear.

The warranty does not extend to:

- shipping and packaging costs.
- using the tool for a purpose other than that for which it was designed.
- the use and maintenance of the machine done in a manner not described in the user manual.

Due to our policy of continuous product improvement, we reserve the right to alter or change specifications without notice. Consequently, the product may be different from the information contained therein, but a modification will be undertaken without notice if it is recognized as an improvement of the preceding characteristic.

READ THE MANUAL CAREFULLY BEFORE USING THE MACHINE.

When ordering spare parts, please indicate the part number or code, you can find this in the spare parts list in this manual. Keep the purchase receipt; without it, the warranty is invalid. To help you with your product, we invite you to contact us by phone or via our website:

- **+33 (0)9.70.75.30.30**
- **<https://services.swap-europe.com/contact>**

You must create a "ticket" via the web platform.

- Register or create your account.
- Indicate the reference of the tool.
- Choose the subject of your request.
- Describe your problem.
- Attach these files: invoice or sales receipt, photo of the identification plate (serial number), photo of the part you need (for example: pins on the transformer plug which are broken).



10. PRODUCT FAILURE

WHAT TO DO IF MY MACHINE BREAKS DOWN?

If you bought your product in a store:

- a) Empty the fuel tank if your product has one.
- b) Make sure that your machine is complete with all accessories supplied, and clean! If this is not the case, the repairer will refuse the machine.

Go to the store with the complete machine and with the receipt or invoice.

If you bought your product on a website:

- a) Empty the fuel tank if your product has one.
- b) Make sure that your machine is complete with all accessories supplied, and clean! If this is not the case, the repairer will refuse the machine.
- c) Create a SWAP-Europe service ticket on the site: <https://services.swap-europe.com> When making the request on SWAP-Europe, you must attach the invoice and the photo of the nameplate (serial number).
- d) Contact the repair station to make sure it is available before dropping off the machine.

Go to the repair station with the complete machine packed, accompanied by the purchase invoice and the station support sheet downloadable after the service request is completed on the SWAP-Europe site

For machines with engine failure from manufacturers BRIGGS & STRATTON, HONDA and RATO, please refer to the following instructions.

Repairs will be done by approved engine manufacturers of these manufacturers, see their site:

- <http://www.briggsandstratton.com/eu/fr>
- <http://www.honda-engines-eu.com/fr/service-network-page;jsessionid=5EE8456CF39CD572AA2AEEDFD290CDAE>
- <https://www.rato-europe.com/it/service-network>

Please keep your original packaging to allow for after-sales service returns or pack your machine with a similar cardboard box of the same dimensions.

For any question concerning our after-sales service you can make a request on our website <https://services.swap-europe.com>

Our hotline remains available at +33 (9) 70 75 30 30.



11. WARRANTY EXCLUSIONS

THE WARRANTY DOES NOT COVER:

- Start-up and setting up of the product.
- Damage resulting from normal wear and tear of the product.
- Damage resulting from improper use of the product.
- Damage resulting from assembly or start-up not in accordance with the user manual.
- Breakdowns related to carburetion beyond 90 days and fouling of carburetors.
- Periodic and standard maintenance events.
- Actions of modification and dismantling that directly void the warranty.
- Products whose original authentication marking (brand, serial number) has been degraded, altered or withdrawn.
- Replacement of consumables.
- The use of non-original parts.
- Breakage of parts following impacts or projections.
- Accessories breakdowns.
- Defects and their consequences linked to any external cause.
- Loss of components and loss due to insufficient screwing.
- Cutting components and any damage related to the loosening of parts.
- Overload or overheating.
- Poor power supply quality: faulty voltage, voltage error, etc.
- Damages resulting from the deprivation of enjoyment of the product during the time necessary for repairs and more generally the costs related to the immobilization of the product.
- The costs of a second opinion established by a third party following an estimate by a SWAP-Europe repair station
- The use of a product which would show a defect or a breakage which was not the subject of an immediate report and/or repair with the services of SWAP-Europe.
- Deterioration linked to transport and storage*.
- Launchers beyond 90 days.
- Oil, petrol, grease.
- Damages related to the use of non-compliant fuels or lubricants.

* In accordance with transport legislation, damage related to transport must be declared to carriers within 48 hours maximum after observation by registered letter with acknowledgement of receipt.

This document is a supplement to your notice, a non-exhaustive list.

Attention: all orders must be checked in the presence of the delivery person. In case of refusal by the delivery person, it you must simply refuse the delivery and notify your refusal.

Reminder: the reserves do not exclude the notification by registered letter with acknowledgement within 72 hours.

Information: Thermal devices must be wintered each season (service available on the SWAP-Europe site). Batteries must be charged before being stored.



BUILDER SAS
32, rue Aristide Bergès - ZI 31270 Cugnaux – France
Made in PRC