

ORIGINAL INSTRUCTIONS



ELECTRICAL MULTI TOOL KIT
(Brush cutter, grass trimmer, pole saw and hedge trimmer)



INSTRUCTIONS MANUAL

RAC4IN1E-1-UK

CAREFULLY READ THESE INSTRUCTIONS BEFORE USE THIS MACHINE
KEEP THIS MANUAL FOR FUTURE REFERENCES

RACING
32, rue Aristide Bergès - ZI 31270 Cugnaux – France
MADE IN PRC 201



CONTENTS

1. SAFETY INSTRUCTIONS	3
2. YOUR PRODUCT	12
3. ASSEMBLY	14
4. OPERATION	20
5. MAINTENANCE AND STORAGE	26
6. DISPOSAL	26
7. DECLARATION DE CONFORMITY	27

1. SAFETY INSTRUCTIONS



WARNING Read all safety warnings and all instructions. Failure to follow the warnings and instructions may result in electric shock, fire and/or serious injury.

Save all warnings and instructions for future reference. The term "power tool" in the warnings refers to your mains-operated (corded) power tool or battery-operated (cordless) power tool.

1) Work area safety

- a) **Keep work area clean and well lit.** Cluttered or dark areas invite accidents.
- b) **Do not operate power tools in explosive atmospheres, such as in the presence of flammable liquids, gases or dust.** Power tools create sparks which may ignite the dust or fumes.
- c) **Keep children and bystanders away while operating a power tool.** Distractions can cause you to lose control.

2) Electrical safety

- a) **Power tool plugs must match the outlet. Never modify the plug in any way. Do not use any adapter plugs with earthed (grounded) power tools.** Unmodified plugs and matching outlets will reduce risk of electric shock.
- b) **Avoid body contact with earthed or grounded surfaces, such as pipes, radiators, ranges and refrigerators.** There is an increased risk of electric shock if your body is earthed or grounded.
- c) **Do not expose power tools to rain or wet conditions.** Water entering a power tool will increase the risk of electric shock.
- d) **Do not abuse the cord. Never use the cord for carrying, pulling or unplugging the power tool. Keep cord away from heat, oil, sharp edges or moving parts.** Damaged or entangled cords increase the risk of electric shock.
- e) **When operating a power tool outdoors, use an extension cord suitable for outdoor use.** Use of a cord suitable for outdoor use reduces the risk of electric shock.
- f) **If operating a power tool in a damp location is unavoidable, use a residual current device (RCD) protected supply.** Use of an RCD reduces the risk of electric shock.

3) Personal safety

- a) **Stay alert, watch what you are doing and use common sense when operating a power tool. Do not use a power tool while you are tired or under the influence of drugs, alcohol or medication.** A moment of inattention while operating power tools may result in serious personal injury.
- b) **Use personal protective equipment. Always wear eye protection.** Protective equipment such as dust mask, non-skid safety shoes, hard hat, or hearing protection used for appropriate conditions will reduce personal injuries.
- c) **Prevent unintentional starting. Ensure the switch is in the off-position connecting to power source and/or battery pack, picking up or carrying the tool.** Carrying power tools with your finger on the switch or energizing power tools that have the switch on invites accidents.
- d) **Remove any adjusting key or wrench before turning the power tool on.** A wrench or a key left attached to a rotating part of the power tool may result in personal injury.
- e) **Do not overreach. Keep proper footing and balance at all times.** This enables better control of the power tool in unexpected situations.
- f) **Dress properly. Do not wear loose clothing or jewellery. Keep your hair, clothing and gloves away from moving parts.** Loose clothes, jewellery or long hair can be caught in moving parts.
- g) **If devices are provided for the connection of dust extraction and collection facilities, ensure these are connected and properly used.** Use of dust collection can reduce dust-related hazards.

4) Power tool use and care

- a) **Do not force the power tool. Use the correct power tool for your application.** The correct power tool will do the job better and safer at the rate for which it was designed.
- b) **Do not use the power tool if the switch does not turn it on and off.** Any power tool that cannot be controlled with the switch is dangerous and must be repaired.
- c) **Disconnect the plug from the power source and/or the battery pack from the power tool before making any adjustments, changing accessories, or storing power tools.** Such preventive safety measures reduce the risk of starting the power tool accidentally.
- d) **Store idle power tools out of the reach of children and do not allow persons unfamiliar with the power tool or these instructions to operate the power tool.** Power tools are dangerous in the hands of untrained users.
- e) **Maintain power tools. Check for misalignment or binding of moving parts, breakage of parts and any other condition that may affect the power tool's operation. If damaged, have the power tool repaired before use.** Many accidents are caused by poorly maintained power tools.

f) **Keep cutting tools sharp and clean.** *Properly maintained cutting tools with sharp cutting edges are less likely to bind and are easier to control.*

g) **Use the power tool, accessories and tool bits etc. in accordance with these instructions, taking into account the working conditions and the work to be performed.** *Use of the power tool for operations different from those intended could result in a hazardous situation.*

5) Service

a) **Have your power tool serviced by a qualified repair person using only identical replacement parts.** *This will ensure that the safety of the power tool is maintained.*

Additional safety rules for hedge-trimmers

- a) **Keep all parts of the body away from the cutter blade. Do not remove cut material or hold material to be cut when blades are moving. Make sure the switch is off when clearing jammed material.** *A moment of inattention while operating the hedge trimmer may result in serious personal injury.*
- b) **Carry the hedge trimmer by the handle with the cutter blade stopped. When transporting or storing the hedge trimmer always fit the cutting device cover.** *Proper handling of the hedge trimmer will reduce possible personal injury from the cutter blades*
- c) **Hold the hedge trimmer by insulated gripping surfaces only, because the cutter blade may contact hidden wiring or its own cord.** *Cutter blades contacting a "live M wire may make exposed metal parts of the power tool 'live" and could give the operator an electric shock.*
- d) **Keep cable away from the cutting area.** *During operation the cable may be hidden in shrubs and can be accidentally cut by the blade.*

- Do not use the hedge trimmer in the rain.
- Wear work gloves, safety goggles, sturdy shoes and long trousers when using the machine.
- Always use both hands to hold the unit.
- Do not attempt to release a blocked/jammed blade before switching off the unit and unplugging.
- Scan the hedge for hidden objects e.g. wire etc. before starting to work.
- Always assume a secure standing position when operating the machine, especially if you use a ladder.
- Never grasp the blade of the hedge trimmer and never hold the hedge trimmer by the guard.
- During operation, persons and animals should remain at a distance of at least 3m or more. The operator is responsible for third persons present in the working area.
- Do not operate the hedge trimmer when barefoot or wearing open sandals. Always wear closed footwear and long sturdy trousers. The use of sturdy gloves, non-skid footwear and safety glasses is recommended. Do not wear loose clothing or jewelry which can be caught in moving parts.
- Thoroughly inspect the area where the hedge trimmer is to be used and remove all wires and other foreign objects.
- Prior to operation, check cutter blades, blade bolts and blade cutter assembly for wear or damage. Do not operate with a damaged or excessively worn cutting device.
- Never operate the hedge trimmer with defective guards or when such protective guards are not in place.
- Prior to operation, always ensure all handles and guards supplied are properly fitted when using the hedge trimmer. Never attempt to use an incomplete hedge trimmer or one with an unauthorized modification.
- While operating the hedge trimmer always be sure of a safe and secure operating position at all times, especially when using steps or a ladder.
- Always lubricate the cutting blade with protective spray before storage.
- Keep all nuts, bolts and screws tight to be sure that the machine is in safe working condition.

Additional instructions for the chainsaw pruner and the brush cutter

- Secure the machine during transport to prevent damage or injury. The tool must be always unplugged. Put the protection on the blade if any. Hold the handle, never the blade.
- Before storage, the tool must be cleaned and regular maintenance must be provided. When storage, always put the protection on the blades.
- Use only appropriate and recommended cutting attachments/carter of protection. Contact our service client or you dealer for this purpose. Do not use non appropriate cutting attachment such as metal multi-piece pivoting chains and flail blades. There is a risk of accidents, injuries and damages with non-appropriate accessories.
- Follow the regular maintenance as given in this instruction manual. Improper maintenance will reduce the life of the tool and can cause malfunction.
- National regulation can restrict the use of the machine; children and person non-trained must not use this tool.
- Inspect the tool before and after use. Do not use the tool if it is not starting correctly, if damaged or malfunction is observed.
- Inspect the tool after dropping or other impacts to identify any significant defects. Switch off and unplug the tool and inspect the tool. Bring the tool for inspection and reparation to a qualified service when necessary.
- Keep bystanders away from the work area. The bystanders must be kept away at least 15
- Always wear protective use slip-resistant foot protection, as well as protective clothing.
- Do not use the tool when it is raining and in bad weather conditions, specifically when there is a risk of lightning and thunderstorms.

Additional instructions for the grass trimmer

CAREFULLY BEFORE USE

KEEP FOR FUTURE REFERENCE

Safe operating practices

Training

- a) Read the instructions carefully. Be familiar with the controls and the correct use of the machine.
- b) Never allow children or people unfamiliar with these instructions to use the machine. Local regulations can restrict the age of the operator.
- c) Keep in mind that the operator or user is responsible for accidents or hazards occurring to other people or their property.

Preparation

- a) Before use check the supply and extension cord for signs of damage or aging. If the cord becomes damaged during use, disconnect the cord from the supply immediately. **DO NOT TOUCH THE CORD BEFORE DISCONNECTING THE SUPPLY.** Do not use the machine if the cord is damaged or worn.
- b) Before use, always visually inspect the machine for damaged, missing or misplaced guards or shields.
- c) Never operate the machine while people, especially **children**, or pets are nearby.

Operation

- a) Keep supply and extension cords away from **cutting means**.
- b) Wear eye protection and stout shoes at all times while operating the machine.
- c) Avoid using the machine in bad weather conditions especially when there is a risk of lightning.
- d) Use the machine only in daylight or good artificial light.
- e) Never operate the machine with damaged guards or shields or without guards or shields in place.
- f) Switch on the motor only when the hands and feet are away from the **cutting means**.
- g) Always disconnect the machine from the power supply (i.e. remove the plug from the mains, remove the disabling device or removable battery)
 - 1) Whenever the machine is left unattended;
 - 2) Before clearing a blockage;
 - 3) Before checking, cleaning or working on the machine;

- 4) After striking a foreign object;
- 5) Whenever the machine starts vibrating abnormally.
- h) Take care against injury to feet and hands from the **cutting means**.
- i) Always ensure that the ventilation openings are kept clear of debris.

Maintenance and storage

- a) Disconnect the machine from the power supply (i.e. remove the plug from the mains, remove the disabling device or removable battery) before carrying out maintenance or cleaning work.
- b) Use only the manufacturer's recommended replacement parts and accessories.
- c) Inspect and maintain the machine regularly. Have the machine repaired only by an authorized repairer.
- d) When not in use, store the machine out of the reach of **children**.

Recommendation

The machine should be supplied via a residual current device (RCD) with a tripping current of not more than 30 mA.











Never allow **children**, persons with reduced physical, sensory or mental capabilities or lack of experience and knowledge or people unfamiliar with these instructions to use the machine, local regulations may restrict the age of the operator.















Additional instructions



- This product must be and operated by experienced users only. It is important that non experienced users get a full training before using this tool
- If you give this machine to another person, please also provide it with this instruction manual.
- Read all markings marked on this tool (symbols, technical data, warnings, etc.). The symbols on the tools are explained in the manual.
- Use this machine as described in this instruction manual. It is strictly forbidden to use this tool for applications other than those described in this manual.
- Failure to follow these instructions can result in serious injury and, in some cases, death.
- This product is intended for private domestic use only. Do not use it for commercial purposes.
- Never let people unfamiliar with these instructions or children use this product.
- National regulations may limit the use of the machine. People under the age of 18 must not use this product.
- Keep in mind that the operator or user is responsible for accidents or risks to other persons or their property.
- Do not use the tool if you are drunk, tired, under the influence of drugs or ill. Do not use the tool if you are not in an adequate physical condition.
- This tool is intended for outdoor use. Never use it indoors.
- Keep people and animals away from the work area. Children and people who do not know how to use this tool must not touch it and handle it.
- Keep bystanders at least 15 m from the machine during operation.
- Use the product only under daylight or under good artificial light.
- Do not use the tool during bad weather conditions (lightning, rain, storm, big winds, etc.)
- Do not use the tool in an area where ventilation is poor.
- Do not use the tool in damp locations.
- Do not use the tool in the presence of flammable liquids or gases.
- Do not operate the product with damaged guards or shields in place.
- Keep hands and feet far from the blade at all times and especially when turning the appliance off and on.
- Do not force the tool.
- Use only the accessories supplied or recommended by the manufacturer. Use of other accessories may result in an accident. Ask your dealer for advice.
- Do not lean. Keep a good balance at all times.
- Keep handles dry, clean and free from oil and grease.
- Use and handle the machine carefully; the cutting tools must keep sharpened and cleaned for better and safer performance. Follow the instructions in this manual to lubricate and change accessories.

- A damaged guard or other part must be properly repaired or replaced by an authorized service center, unless otherwise specified in this instruction manual.
- Do not move the chain with your hand with the wheel moving.
- Do not stop the blade with your hands or other objects.
- Before using the product and after any shock, please check it for signs of wear or damage. Please carry out repairs if necessary.
- Pay attention to foot and cutting injuries
- Inspect and regularly service the product. Repairs should be carried out only by an authorized service center or a similar qualified specialist.
- Children should not play with plastic bags, sheets and small parts! Keep them out of the reach of children. There is a danger of suffocation and suffocation!
- Do not use the product on a slippery surface.
- Do not use the product on steep, slippery slopes.
- When planning your work schedule, allow enough time for rest. Limit continuous use of the device, e.g. use 30 ~ 40 minutes per session, and take 10 ~ 20 minutes of rest between work sessions. Work a maximum of two hours per day
- Keep handles dry, clean and free of oil and grease. Oily, greasy grips are slippery and cause loss of control.
- If the supply cord is damaged, it must be replaced by the manufacturer, its service agent or similarly qualified persons in order to avoid a hazard.
- Wear protective equipment including at least: helmet, hearing protection, ocular protection, gloves, footwear, mask, protective clothes.
- Always use the provided harness.

Symbols

	 	Read instruction manual
		Wear appropriate equipment of protection: helmet, hearing protection, ocular protection
		Wear ocular protection
		Wear hearing protection
		Wear protective gloves
		Wear protective and anti-slippery footwear
		Wear clothes of protection

	Nylon cutting
	Blades
	Warning symbol
	Do not use the tool when raining
	Keep bystanders away
	Unplug the tool: When the plug/cable is damaged or entangled Before maintenance, servicing, storage
	Risk of projections
	Do not touch with the tool foreign objects while it is in operation
	Beware of the kickback
	Keep feet away from the cutting mains
	People must kept away from the work area (15 m)
	Risk of falling objects
	Maximum height of use (15 meters)
	Risk of falling objects
	Maximum height of use (15 meters)

	Do not touch the cutting parts
	Keep hands and feet away from sharp accessories!
	Do not stand in the place where the limbs will fall

Residual risks

Even if you use this product in compliance with all safety requirements, the potential risks of injury and damage remain. The following hazards may arise from the structure and design of this product:

- There are harmful health consequences resulting from the emission of vibrations if the product is used for long periods of time or not properly managed and properly maintained.
- There is risk of injury and property damage due to attachments or the sudden impact of hidden objects when using the blade.
- Risk of injury to persons and property caused by flying objects.
- Prolonged use of this product exposes the operator to vibration and can produce so-called "white finger" disease. To reduce the risk, wear gloves and keep your hands warm.
- If any of the symptoms of "white finger syndrome" occur, seek immediate medical attention. Symptoms of the "white finger" include numbness, loss of sensitivity, tingling, pain, loss of strength, color changes or skin condition. These symptoms usually appear on the fingers, hands or wrists. Risk increases at low temperatures.
- The machine operates with a rotating cutting tool. These cutting movements can lead to projections of certain parts of the material cut and other elements (stones etc.) in an uncontrolled way. Despite the protective equipment installed and the wearing of suitable protective clothing, there is a risk when cutting at the open part of the cutting device. Follow all safety instructions and follow the instructions in this manual.

Intended use

Grass trimmer

The grass trimmer must strictly and only to be used to cut grass or weeds. It can be also used for the cutting of small branches with a maximum diameter of 10mm.

This machine is not intended to cut bushes or other similar plants requiring the tool to get off the ground. Do not use this tool to work on other materials such as stones, clay soils, etc.

Hedge trimmer

Your hedge trimmer is a device used by a person to trim hedges and shrubs by working with one or more blades arranged linearly and moving back and forth. A potential hazard exists if the device is used for other purposes. Improper handling of the hedge trimmer increases the risk of injury from blades. Only the use of spare parts and accessories approved by the manufacturer is permitted.

Chainsaw pruner

The product may only be used with the guide bar/saw chain combination stated in these instructions. It is not permitted to use other types or sizes.

Vertical and horizontal cuts can be performed with this product. Longitudinal sections can only be cut by professionals.

This product should not be used outside of domestic premises e.g. for cutting firewood in forested areas.

The use of this product in case of rain or humid environment is prohibited.

This product is intended for private domestic use only.

Use this multifunction tool only as described in this manual and only for the intended use as described above.

Any other use might lead to damage of the appliance, property or personal injury.

No liability will be accepted for damage resulting from improper use or non-compliance with this manual.

Brushcutter

The brush cutter must be used to cut hard grass, more dense weeds and small branches with a maximum diameter of 10mm.

This machine is not intended to cut bushes or others similar plants requiring the tool to get off the ground. Do not use this tool to work other materials such as stones, clay soils, etc.

2. YOUR PRODUCT

a. Description

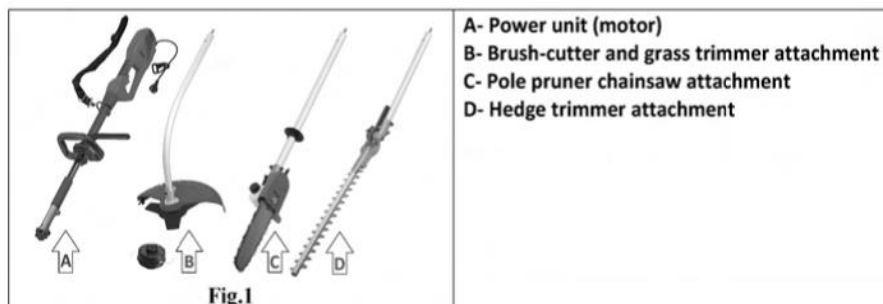
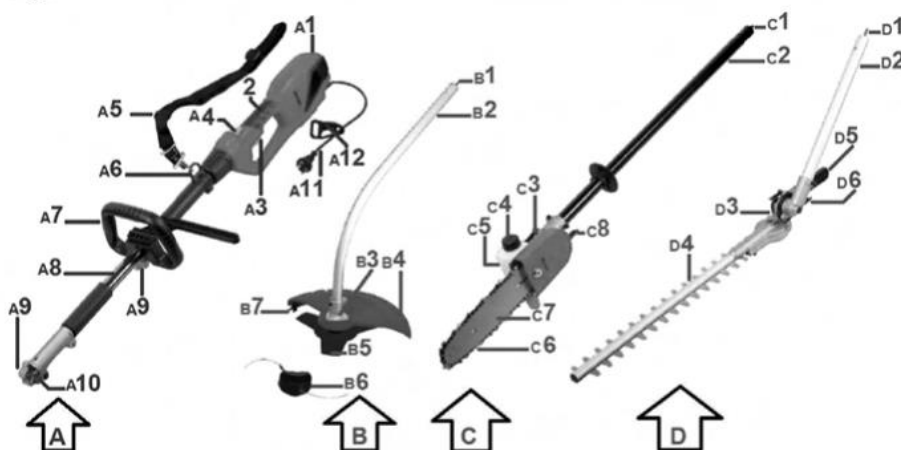

Fig.2



A- Power unit (motor)

- 1- Motor unit
- 2- Rear Handle
- 3- Trigger switch
- 4- Safety switch
- 5- Belt
- 6- Belt anchor point
- 7- Secondary handle
- 8- Main tube
- 9- Tightening knob
- 10- Drive shaft (inside tube)
- 11- Power cable with plug
- 12- Cable holder

- 6- Grass trimmer nylon spool
- 7- Nylon wire cutter blade

C- Pole pruner chainsaw attachment

- 1- Drive shaft (inside the tube)
- 2- Tube
- 3- Gear
- 4- Oil cap
- 5- Oil tank
- 6- Chain
- 7- Guide bar
- 8- Locking ratchet

B- Brushcutter and grass trimmer attachment

- 1- Drive shaft (inside the tube)
- 2- Tube
- 3- Gear
- 4- Protective guard
- 5- Brush-cutter metal blade

D- Hedge trimmer attachment

- 1- Drive shaft (inside the tube)
- 2- Tube
- 3- Gear
- 4- Blades
- 5- Handle
- 6- Locking ratchet

NOTE: The tool is delivered with an additional extension tube



b. Technical data

GENERAL DATA	
Tension	230-240 V~ 50Hz
Power	900 W
HEDGE TRIMMER	
Mass	5,1 kg 5.2kg
PRUNER	
Volume of oil tank	75 ml 100ml
No load speed	4500/min 6900/min
Cutting attachments	Guide bar: 10" 8" Chain: 10", 36 teethes, 8", 36 teethes Gauge: 0.050", Pitch: 3/8" Yes Chain no load speed: 6,5 m/s 6.3m/s
Mass	5 kg 4.9kg
GRASS TRIMMER	
Mass	5,2 kg 3.6kg

No load speed	7200/min	6900/min
BRUSHCUTTER		
Cutting attachments	230mm , 3 tooth metal blade	yes
Mass	3,4 kg	yes
No load speed	6900/min	yes

Sound power level	Hedge trimmer: 101.22 dB(A) Brushcutter: 98.53 dB(A) Grass trimmer: 102.47 dB(A) Pruner: 102.36 dB(A) K = 3 dB(A)	
Sound pressure level	Hedge trimmer: 90.22 dB(A) Brushcutter: 91.1 dB(A) Grass trimmer: 91.2 dB(A) Pruner: 90.35 dB(A) K = 3 dB(A)	
Guarantee sound power	106 dB(A)	
Vibration value	Hedge trimmer	Front handle: 2.725 m/s ² Rear handle: 3.056 m/s ² K= 1.5 m/s ²
	Brushcutter	Front handle: 4,735 m/s ² Rear handle: 2,791 m/s ² K=1.5 m/s ²
	Grass trimmer	Main handle: 2.720m/s ² Auxillary handle: 2.785m/s ² K= 1.5 m/s ²
	Pruner	Front handle: 3.146 m/s ² , Rear handle: 2.219 m/s ² , K=1.5 m/s ²

Information

The declared vibration total value has been measured in accordance with a standard test method and may be used for comparing one tool with another;

The declared vibration total value may also be used in a preliminary assessment of exposure.

Warning:

That the vibration emission during actual use of the power tool can differ from the declared total value depending on the ways in which the tool is used; and

of the need to identify safety measures to protect the operator that are based on an estimation of exposure in the actual conditions of use (taking account of all parts of the operating cycle such as the times when the tool is switched off and when it is running idle in addition to the trigger time).

Wear hearing protection

3. ASSEMBLY

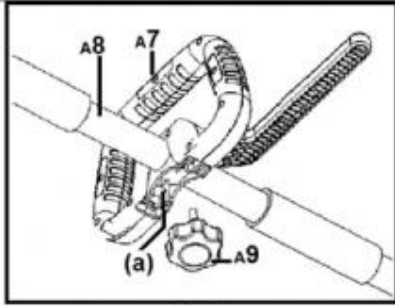

Fig.3

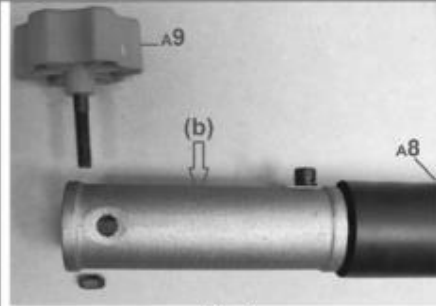

Fig.4

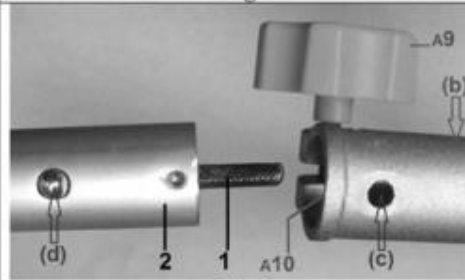

Fig.5

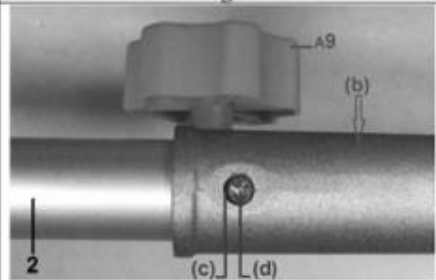

Fig.6

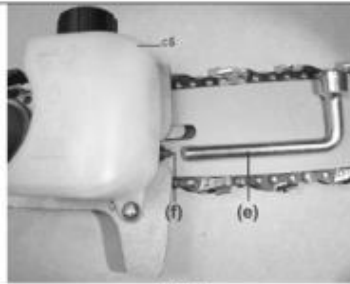

Fig.7

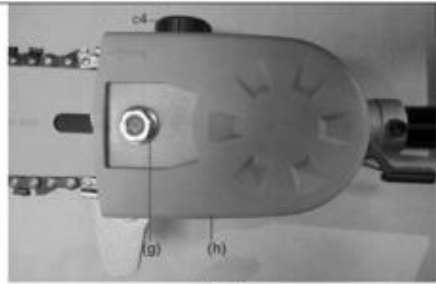

Fig.8

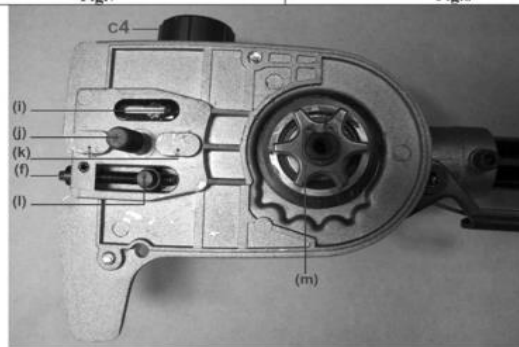

Fig.9

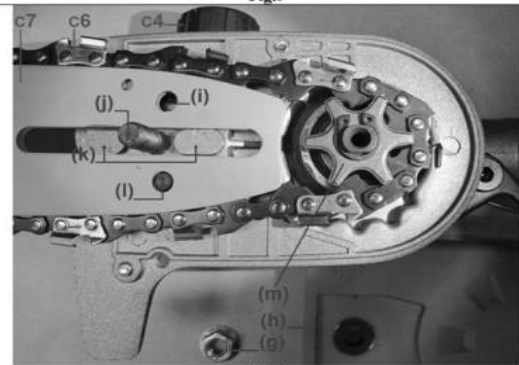

Fig.10

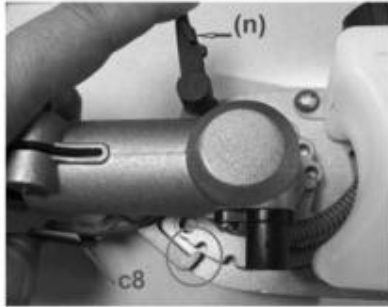
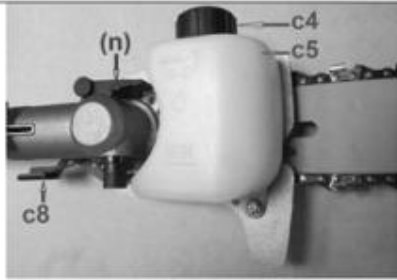

Fig.11

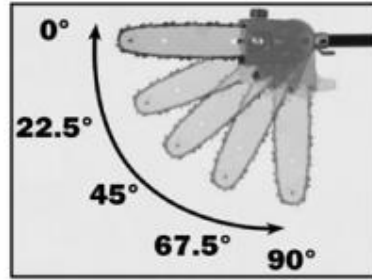

Fig.12

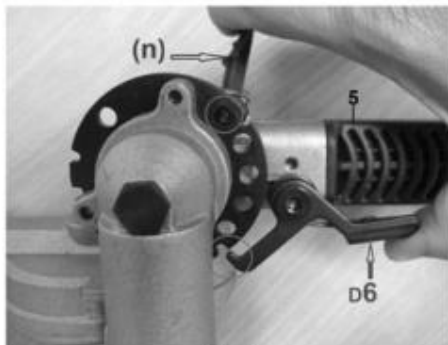

Fig.13

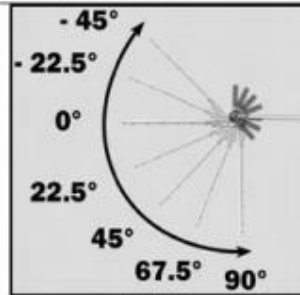
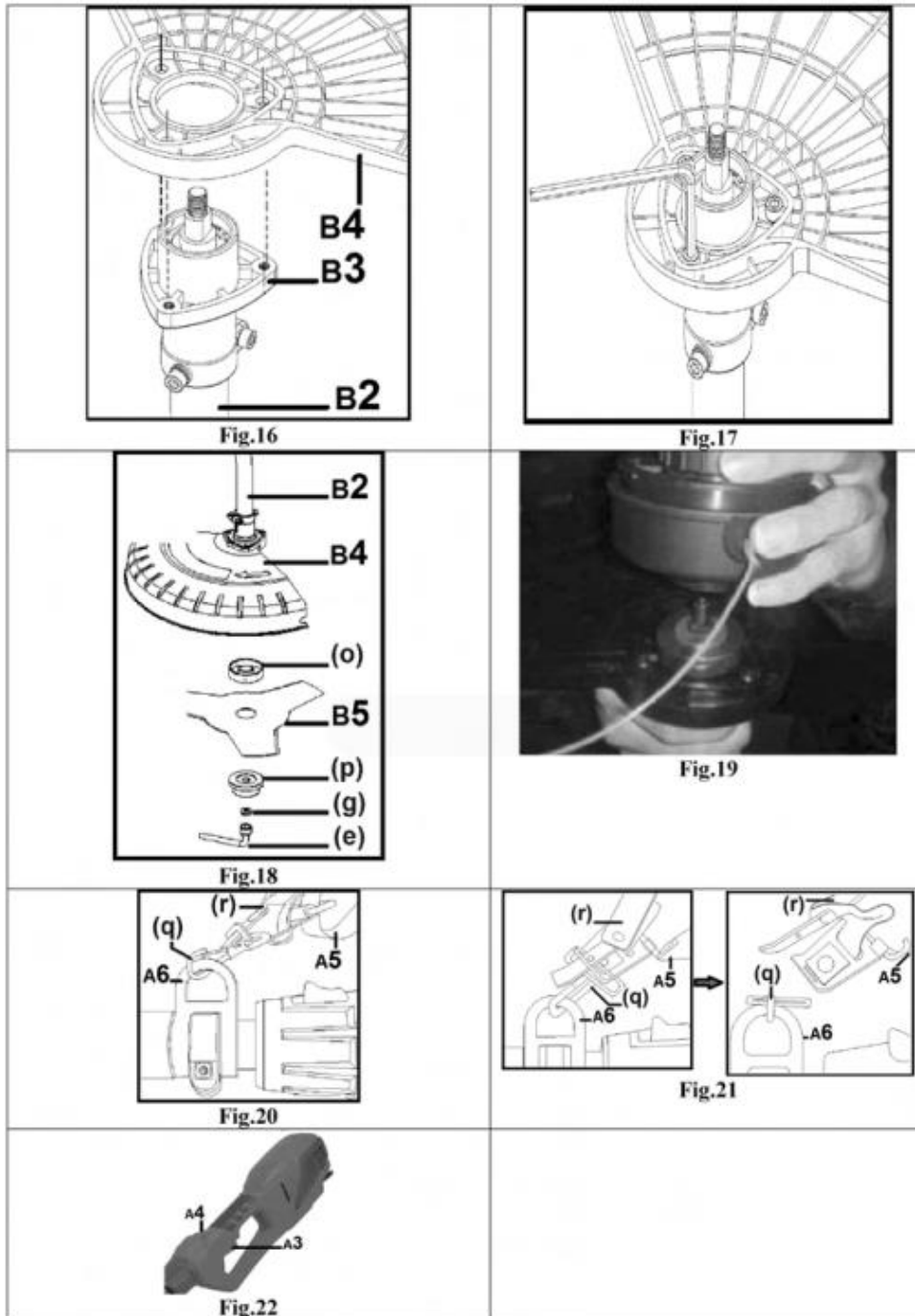

Fig.14



Fig.15



a) **HANDLE ASSEMBLY (FIG 3)**

Loosen the tightening knob (A9). Open the handle bracket (a).
 Fit the handle (A7) onto the power unit main tube (A8).
 Close the bracket (a) and tighten the knob (A9).

b) **CONNECTING AN ATTACHMENT (FIG.4 & 5 & 6)**

Fig 4

Applicable to first time assembly only.

Install the tightening knob (A9) onto the connecting bracket (b) with the provided nut.

Fig 5

Loosen the tightening knob (A9) onto the connecting bracket (b) on the main tube (A8). Press the lock button (d).

Align and connect the drive shaft (A10) of the power unit with the draft shaft (1) of the tool attachment.

Push the tool attachment tube (2) into the connecting bracket (b).

Fig 6

Push the attachment tube (2) into main tube connecting bracket (b) until you see and hear a click from the lock button (d) engaging into the whole (c) on the connecting bracket (b).

Tighten the knob (A9).

To disconnect a tool attachment tube (2) from the power unit tube (A8), loosen the connector knob (A9), press the lock button (d) and firmly pull out the tool attachment tube (2).

c) POLE CHAINSAW PRUNER

NOTE: Be sure to fill the oil reservoir with the appropriate chain oil otherwise you will seize and burn out the chain.

When mounting the saw chain, use protective gloves as the saw chains as very sharp edges.

Chain tension adjustment (fig.7)

- Tighten the chain tension by turning the tension nut (f) clockwise.
- To loosen the chain tension, turn the tension nut (f) counterclockwise.

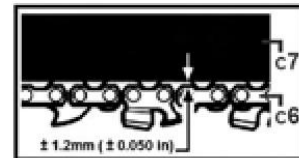

IMPORTANT: the chain must neither be too tight or too loose. You must be able to lift the chain a few mm away from the bar.

Replacement of the chain (Fig.8, 9, 10)

- Loosen the nut (g) and remove the chain cover (h).
- Remove the guide bar and the chain (if applicable).
- Mount the guide bar (c7) onto the two guiding poles (k) and chain tensioner pin (l).
- Lift the saw chain (c6) around the bar (c7) and sprocket (m).
- Slightly tighten the chain tensioner nut (f) clockwise then install the chain cover (h) and fasten the nut (g) with fingers.
- Adjust the chain tension by turning the chain tension nut (f) clockwise until the chain sits comfortably and not too tightly into the chain bar (refer to “a” point above). Then check the chain for smooth rotation and correct tension while moving it by hand. If necessary, readjust and tighten.
- Tighten then the nut (g) securely with the provided key (c).

WARNING

It is very important to maintain the proper chain tension; rapid wear of the guide bar or the chain coming off easily can be caused by improper tension, especially when using a new chain, take good care as it will expand when first used.

Adjusting working angle (Fig. 11+12)

NOTE: always fit the blade cover!

To adjust the cutting angle in one of the five positions, please proceed as follows:

- Pull both the locking ratchet (C8) and the locking pin (n) so they disengage from their respective notches.

- Adjust the cutting head to desired working angle then lock the ratchet (C8) and the locking pin (n) ensuring that they both lock firmly into their notches.

d) Hedge trimmer

This attachment comes supplied fully assembled.

For service: lubricate with a grease gun every six months or 20 hours of use.

Adjustable working angle (Fig.13+14)

NOTE: Always fit the blade cover

To adjust the cutting angle in one of the seven positions, please proceed as follows:

- Pull both locking ratchet (D6) and the locking pin (n) so they disengage from their respective notches.
- Adjust the cutting head to desired working angle then lock the ratchet (D6) and the locking pin (n) ensuring that they both firmly into position in their notches.

e) BRUSH CUTTER AND GRASS TRIMMER

SAFETY PROTECTIVE GUARD ASSEMBLY (FIG.16&17)

Assemble the protective guard using the three bolts and hex key supplied. Line up the three holes, fix and tighten the three bolts using the hex key supplied.

METAL BLADE ASSEMBLY (FIG. 18)

Align and insert retaining plate (o) into the drive shaft.

Set the metal blade (b5) on retaining plate (o).

Position locking plate (p) on the blade (b5).

Insert nut (g) inside the locking plate (p) and tighten with the wrench (e).

Ensure that the blade is tightly and firmly assembled.

NYLON SPOOL ASSEMBLY (FIG.19)

Remove the metal if fitted

Store the blade retaining plate (o), locking plate (p), nut (g) and blade in a safe place.

Mount the nylon spool (b6) onto the threaded end of the drive shaft and tighten it.

WARNING! Do no use the line cutting head without the plastic protective guard.

Remark: remove the cutter protection before using the lawn trimmer.

f) FITTING THE BELT (FIG. 20 & 21)

Clip the hook (q) of the belt (A5) to the anchor point (A6) on power unit tube.

Adjust the length and comfort.

The belt is fitted with a quick release system (r) (Fig. 21).

Pull the tag (r) to quickly release the belt from the tool (note that the hook (q) will remain attached to the anchor point (A6)).

Note: balance the unit so that attachment head stays parallel to the ground when standing in your normal working position.

4. OPERATION

When you operate the tool, always wear full-length trousers, as well as sturdy, closed footwear that provide good support. Do not operate the tool wearing shorts, when barefoot or wearing open sandals.

Do not wear loose clothing or jewellery that can be drawn into the moving parts. Keep long hair away from the moving parts (for example put it in a hair net).

Wear protective equipment and always wear protective goggles while operating the tool. Wearing protective equipment such as a dust mask, non-slip footwear, protective gloves, a helmet and hearing protection (depending on the type and application of the electrical device concerned) reduces the risk of injury.

When performing work that generates dust, wear a dust protective mask to prevent dust irritation.

Each time before you use the tool, check the integrity of the product's power cord and your own extension cord for signs of damage and ageing. Do not use the tool if the cord is damaged or worn. The product should only be operated when its accessories are in perfect working order.

Any damaged or defective components should be repaired immediately by a qualified technician. Never attempt to use an incomplete, not fully assembled or modified tool.

Under no circumstances should the tool be operated while safety devices or protective guards or shields are damaged or if safety equipment such as protective devices is not installed.

Only use an extension cable fitted with coupler according to the norm IEC 60320-2-3.

Only extension cord used should have a minimum cross section of 1.5mm². All plug-in connections should have an earth contact and water-spray shielding.

Browse the working area to:

Remove all objects and foreign materials that may be thrown by the tool.

Identify hard objects or risk areas to avoid damaging the tool.

Before starting the product

- Local or national regulations may limit the use of the product during specific hours of the day and only by certain users; seek information with your local authorities.
- Never operate the product when you are tired, ill or upset, under the influence of medication, alcohol or drugs.
- Only operate product after completely assembling it.
- Do not operate the tool if protective device is not fully or properly assembled!
- Before each use, check the tool for any signs or damage.
- Prior each use, check the power cords for signs of damage. Under no circumstances should the power cord be used if it shows any signs of damage.
- Only use splash-proof extension cord approved for outdoor use and marked accordingly. Make a loop in the extension cord and hang into the cable holder.
- Ensure that the tool is only connected to conventional sockets with a 230V alternating current supply.
- The tool can plug into any 230Vac outlet with 10 amps of fuse protection. The electrical outlet is to be protected by an earth leakage circuit breaker (ELCB) with a max triggering current of 30mA (i.e. the appliance should be supplied via a Residual current device RCD with a tripping current of not more than 30mA).
- Always inspect visually that the product does not show signs of use and damage.
- Check that the screws, bolts and nuts are well tightened.
- Replace any used or damaged part, and tighten firmly the screws, bolts and nut when needed.
- Check the cutting element proper operation.
- The blade of the hedge trimmer works in opposite direction and has two cutting sides to provide greater cutting capacity and performance.
- Repeat several times the starting and stopping of the machine to become familiar with it.
- Make trial work on small shrubs or hedges branches to become familiar with handling the machine.
- Ensure that the tool is properly connected to power supply. Lay the extension cord behind you.
- Wear appropriate equipment.
- Clear working area of any objects likely to pose hazards.
- Inform persons to stay away from working area and machine while you are working.
- Firmly hold tool with both hands, and always maintain balanced and secure and secure position.

- Place the cutting element above the cutting area. Do not make sudden movements.

During use

- Always direct the cable to the rear away from the tool and working path. Make sure the power cord is kept behind and away from the device while you work.
- If the power cord or extension cord becomes damaged during use, disconnect the supply cord from the mains immediately. **DO NOT TOUCH THE CORD BEFORE DISCONNECTING THE SUPPLY CORD FROM ITS POWER SOURCE.**
- If the supply cord is damaged, it must be replaced by the manufacturer, its service agent or similarly qualified persons in order to avoid a hazard.
- Do not carry the tool by the cable. Never use the power cord as a handle to lift or carry the tool.
- Always disconnect the product from the main supply in the following circumstances:
 - o Whenever you leave the tool, when the tool is not in use, is being carried/transported, or is left unattended
 - o Before clearing a blockage, while examining, cleaning or unclogging the cutting devices.
 - o Before checking, cleaning or working on the product, performing maintenance on it or attaching accessories to it.
 - o If the device strikes a foreign object (e.g. fence) or starts to vibrate abnormally.
- If the product bumps into any object during operation, stop it and control that it is has not been damaged. Replace or repair any damaged piece in a qualified service centre.
- Use the tool in daylight or with an adequate and good artificial light.
- Do not overreach. Keep proper footing and balance at all times.
- Bear in mind that the force generated by an electrical device can made you lose your balance. Therefore make sure that your feet are firmly planted and that your body is well balanced when you are operating the product.
- Never operate the tool on damp areas or wet grass.
- When use the tool on slopping areas:
 - o Do not work in areas with unduly steep slopes.
 - o Always be sure of your footing and slopes. Position yourself horizontally to the slope and make sure your feet are firmly planted.
 - o Exercise particular caution whenever you change directions while working on slope.
- Walk, never run. Walk at a measured pace while operation the tool. Do not run.
- Do not assume of your knowledge of the tool. Remember that a split second of negligence is sufficient to cause serious damage. Be aware of your surroundings and stay alert for potential hazards that you may not heat while operating the tool.
- Any distraction can make you lose control of the tool. If someone calls you, stop the tool before turning towards the caller.
-

a. Starting and stopping the machine

Be sure that this tool is fully and correctly assembled as explained in this instruction manual. The tool must be plugged to an appropriate extension cord. Then plug the extension cord to an appropriate socket.
Form a loop with the extension cord, and hook it over the cable holder (A12).
Switch on: press the safety switch (Fig.22, A4), then press the trigger switch (Fig.22, A3).
Switch off: release the trigger switches (Fig.22, A3).

Warning! The cutting means (blades, nylon line, and chain) continue to move for a few seconds after the tool is switched off. Wait until the cutting means come to a complete standstill before placing the machine down.

Caution! Do not touch the moving cutting means.

b. Use of the chainsaw pruner

NOTE: Do not use this chainsaw pruner to felling trees.

Cutting limbs of fallen trees

Check if to which side the limb is bent. Then make the initial cut from the bent side and finish by saving from the opposite side.

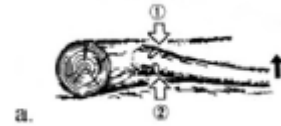

WARNING! Be alert the springing back of a cut limb

Pruning a standing tree

Cut up the bottom, finish down the top.

WARNING!

Do not use an unstable foothold or ladder.

Do not overreach.

Do not cut above shoulder height.

Always use both hands to hold the tool.

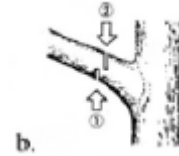

Cause and prevention of the kickback

Kickback may occur when the nose or tip the guide bar touches an object, or when the wood closes in and pinches the saw chain in the cut.

Tip contact in some cases may cause a sudden reverse reaction, kicking the guide bar up a back towards the operator.

Pinching the saw chain along the top of the guide bar may push the guide bar rapidly back towards the operator.

Either of these reactions may cause to lose control of the saw which could result in serious personal injury. Do not rely exclusively upon the safety devices built into your saw. As a chainsaw user, you should take several steps to keep your cutting jobs free from accident or injury.

Kickback is the result of tool misuse and incorrect of operating procedures or conditions and can be avoided by taking proper precautions as given below:

- Only use replacement bars and chains specified by the manufacturer. Incorrect replacement bars and chains may cause chain breakage and/or kickback.
- Follow the manufacturer's sharpening and maintenance instructions for the saw chain. Decreasing the depth gauge height can lead to increased kickback.

Chainsaw oil

The lifetime of the chain and guide bar depends greatly on the quality of lubricant used. Choose a chain lubricant that is environment friendly. Use quality chainsaw oil without sticking additive for lubricating the saw chain and guide bar.

Do not use used or recycled oil as it could damage the oil pump. Used oil does not have the required lubricating properties for lubricating the saw chain and in addition, it is harmful for the environment.

Oils for saw chains stick when not being used for longer time. This can cause damage to oil pump or parts leading the oil. Therefore, prior storage:

- Empty the oil from oil tank
- Fill in the tank with little engine oil
- Allow the chainsaw to run for some time to enable the oil leading and oil pump clean.
- Before other use of the chainsaw refill tank with the oil for saw chain again.

Store oil in certified containers (such as jerry cans).

Filling oil tank

Clean the oil filler cap and its circumference before opening it, so as to avoid impurities getting inside the tank.

Fill the tank.

Screw the oil tank cap and wipe away any oil spills.

In order to lubricate the saw chain sufficiently, there must be enough saw chain oil in the tank at all times. The oil level can be checked in the viewing glass. The oil level may not be below or above MIN or MAX.

Saw chain lubrication

Clean to avoid premature wear of the tool, the chain and the guide bar must be lubricated homogeneously throughout the operation.

The lubrication is automatic.

Never use the chainsaw if the chain is not lubricated. If the chain is dry, the entire cutting device may become damaged.

It is therefore essential to check both the lubrication of the chain and the oil level before each use. Never use the chainsaw when the oil level is below MIN.

c. Use of the hedge trimmer

The tool can be used to cut small bushes or trim small bushes.

The trimming cut with an angle of 5°, between the hedge and the blade, is kept during the operation (ill 2 below).

Both sides of the cutting blades allow to trim both ways; from right to left to left to right (ill. 3).

To achieve a regular trim, we recommend you to limit the side of the hedge with a wire or line.

Only the branches higher the top of the wire or line should be cut (ill. 4).

The sides of a hedge should be trimmed from the bottom to top (ill. 5).

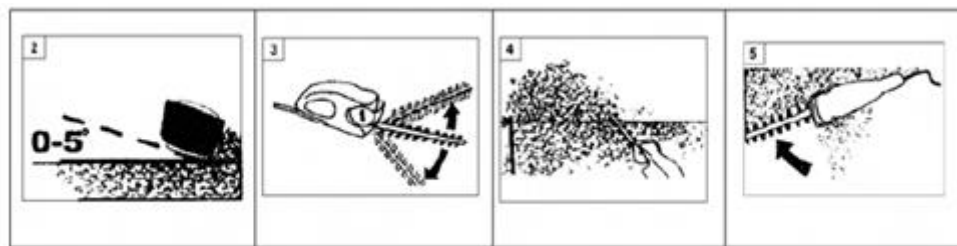

Important

Large branches should be cut with shears

In case the blades get blocked, stop and unplug the hedge trimmer. Then, remove the blockage.

d. Use of the brushcutter/grass trimmer

Cutting with a metal blade

The 3 tooth metal blade provided with the machine is intended for cutting bushes and weeds. Do not use saw blade with this machine.

Warning:

- Do not use brushcutter for cutting trees.
- Do not cut with dull, cracked or damaged metal blade.
- Before cutting, inspect the working area for obstruction (such as boulders, metal stakes or strands of wire from broken fences) and remove them. If an obstruction cannot be removed, mark its location so that you can avoid it with the blade. Rocks and metal will dull or damage the blade. Wires can catch on the blade head and flap around or be thrown into the air.
- Use the shoulder harness at all times! Harness the unit on the right side of your body. Adjust the harness that the unit hangs a few inches above ground level.

Scything weeds

This is cutting by swinging the blade in a level

This method quickly allows to clear areas of field grass and weeds.

Scything should be not be used to cut large, tough weeds or woody growths.

Scything can be done in both directions (warning! Debris may be thrown towards user's direction) or just in one direction (which results in the debris being thrown away from the user). Use the side of the blade that is rotating away from you and tilt down the blade slightly on this same side.

If kickback occurs, the blade may dull or the material so thick and hard that you should use other tool instead of this machine.

Do not force the blade to cut.

Do not change the angle of cut during operation.

Avoid using any pressure or leverage which could cause the blade to bind or crack.

Kickback

An uncontrolled kickback of the blade may occur when using the brush cutter.

This kickback phenomenon occurs in particular when performing cuts in the critical angle of the blade of the blade, by example the angle between 12-and-2 o'clock.

Never use the trimmer in the angle between 12-and-2 o'clock.

Never use such a blade angle for cutting solid materials such as bushes, roots whose diameter is greater than 3 cm because the trimmer could then be violently projected to the side and may cause injury.

This uncontrolled kickback of the blade is more likely to occur when the user cannot see the material being cut.

This uncontrolled kickback can cause serious injury or even death to the user or other people or animals. Always keep people and animals at least 15 m away from the machine.

Cutting with nylon head

Grass trimming

Feeding the trimmer carefully into the material you wish to cut. Tilt the head slowly to direct debris away from you.

If cutting up to a barrier such as a fence, wall or tree, approach from an angle where any debris ricocheting off the barrier will fly away from you. Move the line head slowly until the grass is cut right up the barrier but do not jam (over feed) the line into the barrier.

If trimming up to a wire mesh or chain linked fence be careful to feed only up to wire. If you go too far the line will snap off around the wire. Trimming can be done to cut through weed stems one at a time. Place the trimmer line head near the bottom of the weed. Never high up since could cause the weed to chatter and catch the line. Rather than cut the weed right through, just use the very end of the line to wear through the stem slowly.

Scalping and edging

Both of these done with the line head tilted at a steep angle. Scalping is removing top growth, including roots, leaving the earth bare.

Edging is trimming the grass back where it has spread over a sidewalk or drive way.

During both edging and scalping, hold the unit at a steep angle and in a position where the debris and any dislodged dirt and stones, will not come back towards you even if it ricochets off any hard surface.

Although the figures show examples of how to edge and scalp, every operator must find for himself the angles which suits his body size and cutting situation.

WARNING!

- **Do not use a steel blade for edging or scalping**
- **Do not trim in any area where there are strands of fencing wire**
- **Do not cut where you cannot see what the cutting device is cutting.**

Adjusting the line length

The grass trimmer is equipped with a semi-auto type nylon line head that allows the operator to advance the line without stopping the engine.

When the line becomes short, lightly tap the head on the ground while running the engine at full throttle.

Each time the head is bumped, the line advances about 25 mm.

For better effect, tap the head on bear ground or hard soil.

Avoid bumping in thick, tall grass or soft ground.

5. MAINTENANCE AND STORAGE

a) Before maintenance and storage

- Keep all nuts, bolts and screws tight to be sure the tool is in safe working condition.
- Check the cutting devices frequently for signs of wear and/or deterioration.
- Replace any worn or damaged part.
- Make sure to use only genuine/original replacement parts and accessories.
- For reasons for safety, any worn or damaged component should be replaced or repaired immediately by a qualified technician.
- When not in use, store the tool only in a dry place that is inaccessible to children.
- Always wear gardening gloves when handling or working near the cutting element.

- Always check the machine before and after the use. In case of malfunction or damaged parts, do not use the tool and bring it to a qualified service for inspections and reparations.
- Do not repair the tool by yourself.
- Only use original accessories and spare parts. Contact our service or your dealer to know the recommended parts/accessories to use.

b) Cleaning

- Clean the plastics parts with a soft and clean cloth and dry the housing carefully. Do not use aggressive cleansing agent (solvent, abrasive cleansers) or an abrasive sponge or any sharp objects.
- Do not use any caustic chemical to clean the plastics parts.
- Never put or immerse the product in water or any liquid, and ensure that water does not penetrate the tool. Never splash with water or clean with the high pressure hose! Do not clean under running water.
- After each cutting operation, clean the cutting blade with a soft brush and cloth with lubricating oil and spray a thin layer of protective oil on the whole blade.
- Always keep the ventilation slots in motor housing clean. Clean ventilation holes with soft brush.

a. Storage

- Keep product, user manual and accessories in the original packaging.
- Clean tool before storage.
- Always lubricate the cutter blade with protective oil spray storage.
- Store the machine with supplied cutter blade protection cover.
- It is recommended to store the product in a clean, dry location, protected from humidity, frost and dust, and keep it out of children's reach (e.g. high or in a locked up place).
- Do not store product in temperatures lower than 0°C (32°F).

6. DISPOSAL



Electrical products should not be discarded with household products. According to the European Directive 2012/19/EU on waste electrical and electronic equipment and its implementation into national law, electrical products used must be collected separately and disposed of at collection points provided for this purpose. Talk with your local authorities or dealer for advice on recycling.

7. DECLARATION DE CONFORMITY

RACING

ZI, 32 rue Aristide Bergès – 31270 Cugnaux – France

Declare that the following machine:
ELECTRICAL MULTI TOOL KIT (Brush cutter, grass trimmer, pole saw and hedge trimmer)

RAC4IN1E-1-UK
Serial number: 20170802065-20170802364

In conformity with the Directive Machine 2006/42/EC and with the regulations transposing it.

Also in conformity with the following Directives:
EMC Directive 2014/30/EU
RoHS Directive 2011/65/EU
Noise emission 2000/14/CE Annex V + 2005/88/CE
Noise emission 2000/14/CE Annex VI + 2005/88/CE

Measured sound power level	Hedge trimmer: 101.22 dB(A) Brushcutter: 98.53 dB(A) Grass trimmer: 102.47 dB(A) Pruner: 102.36 dB(A) K = 3 dB(A)
Guarantee sound power	106 dB(A)

Notified body:

TÜV Rheinland LGA Products GmbH - Tillystraße 2 - 90431 Nürnberg
Accredited by Zentralstelle der Länder für Sicherheitstechnik (ZLS).

Notified under No. **0197** to the EC Commission.

Certification EC-type: **BM 50298414 0001**

Also in conformity with the following standards

EN 60745-1:2009+A11:2010	EN ISO 11806-1:2011
EN 10517:2009+A1:2013	EN 55014-1:2006+A1:2009+A2:2009
EN ISO 11680-1:2011	EN 55014-2:2015
EN ISO: 12100: 2010	EN 61000-3-2:2014
EN 60335-1:2012+A12:2014	EN 61000-3-3:2013
EN 50636-2-91:2014	

Responsible of the technical file: Mr Patriarca

Cugnaux, 08/05/2017

Philippe MARIE / PDG

