



CHAINSAW

RAC2525-1

INSTRUCTIONS MANUAL

Read the instructions before use the tool

32, rue Aristide Bergès - ZI 31270 Cugnaux – France
MADE IN PRC 2018



CONTENTS

1. SECURITY INSTRUCTIONS	3
2. YOUR PRODUCT	7
3. ASSEMBLY	10
4. FILLING THE FUEL TANK	12
5. OPERATION	13
6. MAINTENANCE AND STORAGE	20
7. DECLARATION OF CONFORMITY	24

1. SAFETY WARNINGS

- WARNING! When using this type of power tool, basic precautions should always be followed to reduce the risk of fire, electric shock and injury.
- Read all instructions carefully before attempting to use this product and retain these instructions. Be familiar with all the operations described in these operating instructions. This product must be operated and operated by experienced users.
- If you are giving this machine to others, please also provide them with this instructions manual.
- Also read all markings on the product. The symbols on the tools are explained in the manual.
- Use this machine as described in this instruction manual. It is strictly forbidden to use this tool for applications other than those described in this manual.
- Failure to follow these instructions can result serious injuries and, in some cases, death.
- This product is intended for private domestic use only. Do not use it for commercial purposes.
- Never let people unfamiliar with these instructions or children use this product.
- National regulations may limit the use of the machine.
- People under the age of 18 must not use this product
- Keep in mind that the operator or user is responsible for accidents or risks to other persons or their property.
- Do not use the tool if you are drunk, tired, under the influence of drugs or ill. Do not use the tool if you are not in an adequate physical condition.
- This tool is intended for outdoor use. Never use it indoors.
- When transporting the machine:
 - Secure the machine during transport to prevent loss of fuel, damage or injury.
 - Use a carrying case to protect the cutter during transport.
- Keep people and animals away from the work area. Children and people who do not know how to use this tool should not touch it and handle it.
- Keep them at least 15 m from the machine during operation,
- Use the product only under daylight or under good artificial light.
- When using the machine, always wear full protective equipment including a helmet, protective mask, ear protection, gloves, non-slip footwear and protective clothing.
- Wear appropriate clothing. Do not wear loose or unbuttoned shirts. Do not wear jewelry that may come in contact with moving parts. If you have long hair, tie them down and wear an appropriate safety helmet.
- Do not operate the product with damaged guards or shields or shields or shields in place.
- Keep hands and feet of the appliance at all times and especially when turning the appliance off and on.
- Do not use the tool in an area where ventilation is poor. Gas emissions can cause injury.
- Do not work when it rains and in bad weather. Do not use the tool in damp locations.
- Do not use the tool in the presence of flammable liquids or gases.
- Caution: The machine releases gases when it is used. Avoid coming into contact with these gases.
- Keep the work area clear. Before working, inspect the work area and remove any materials or objects that could cause accidents.
- Do not force the tool.
- Use only the accessories supplied or recommended by the manufacturer. Use of other accessories may result in an accident. Read the "Technical Data" section of this instruction manual or ask your dealer for advice.
- Do not lean. Keep a good seating and balance at all times.

- To maintain tools and accessories carefully, keep cutting tools sharp and clean for better and safer performance. Follow the instructions in this manual to lubricate and change accessories.
- Always inspect the machine before and after operation. If the tool is damaged or faulty, stop using the tool and bring it to an authorized service for inspection and repair.
- Turn off the tool after use, when you leave it unattended, when changing these

accessories and before servicing.

- Keep handles dry, clean and free from oil and grease.
- Be concentrated when using the tool. Look at what you do, make sense and do not use the tool when you are tired.
- Remove the blade guard before using the tool.
- A damaged guard or other part must be properly repaired or replaced by an authorized service center, unless otherwise specified in this instruction manual.
- Do not use the tool if the starter is not working (if it cannot be turned ON and OFF).
- Place the equipment in a well-lit area on a flat, stable, dry and well-ventilated surface, away from flammable materials and with plenty of space for sparking and sharpening waste.
- Do not allow anyone, especially children, to come within a radius of at least five meters around the work area when all work is in progress.
- Immediately stop the tool in the event of a malfunction of the motor or the ON/OFF button or in case of unusual noise.
- Do not use the tool if the starter is damaged.
- Do not move the chain with your hand with the wheel moving.
- Do not stop the chain with your hands or other objects.
- Treat the chain teeth with caution during operation; they can cause severe cuts.
- When not in use, the machine must be stored in a dry, locked place out of the reach of children.
- Before using the product and after any shock, please check it for signs of wear or damage. Please carry out repairs if necessary.
- Always switch off the machine:
 - Every time you leave the device unattended;
 - Before releasing an obstruction;
 - before checking, cleaning or working on the product;
 - after hitting a foreign object;
 - Every time the product starts to vibrate abnormally.
- Pay attention to foot and cutting injuries.
- Inspect and regularly service the product. Repairs should be carried out only by an authorized service center or a similar qualified specialist.
- When not in use, store the product out of the reach of children.
- Children should not play with plastic bags, sheets and small parts! Keep them out of the reach of children. There is a danger of suffocation!
- When transporting the tool, always add the blade guard to the blade. Always carry the tool by holding the handle, never the blade.
- Do not use the product on a slippery surface.
- Do not use the product on steep, slippery slopes.
- When planning your work schedule, allow enough time for rest. Limit continuous use of the device, eg use 30 ~ 40 minutes per session, and take 10 ~ 20 minutes of rest between work sessions. Work a maximum of two hours per day
- If the machine has struck foreign objects, check if the tool is damaged and bring it to repair if necessary.
- Do not place any part of the body on the chain when the chainsaw is operating. Before starting the chain saw, make sure that the chain is not in contact with anything. A moment of inattention during use may cause your clothing or body part to stick to the chain.
- Always hold the chainsaw back handle with your right hand and the front handle with your left hand. Hold the chainsaw by inverting your hands increases the risk of personal injury and should never be used.
- For the chainsaw designed with the chain guide on the left side, the reference to the "right hand" and "left hand" positions is reversed.
- When cutting a branch that is under stress, pay attention to the risk of elastic return. When the tension of the wood fibers is released, the spring-loaded limb may strike the operator and / or project the chain saw out of control.
- Exercise extreme caution when cutting brush and young shrubs. Fine materials can grip the cutting chain and be thrown as a whip in your direction, or you lose balance under the effect of traction.

- Follow the instructions for lubrication, tension and chain change accessories. A chain whose tension and lubrication are incorrect can either break or increase the risk of rebound.
- Keep handles dry, clean and free of oil and grease. Oily, greasy grips are slippery and cause loss of control.
- Cut only wood, as well as for pruning and cutting wood. Do not use the chain saw for any other purpose. For example: do not use it to cut plastic, masonry or construction materials other than wood. Using the chain saw for operations other than those specified may result in hazardous situations.
- Be careful when using the machine during stormy weather. Do not use the machine during lightning, thunderstorms or in bad weather in general.
- There is advantage of using the provided spiked bumper when cutting trees and thick branches.
- Perform regular functional check of the clutch. It should be no have chain movement at idling speed.
- When operating the tool, be careful of the emission of exhaust gases, lubrication oil mist and saw dust; avoid to be exposed to these and wear protective equipment.
- Wear protective gloves when assembly, disassembly, sharpening chain tensioning and when handling the guide bar.
- Guide-bar and chain adjustments shall be perform with the engine stopped.
- Regularly check and test the chain brake.
- Hazards may be encountered while using the saw, such as blockage of the saw chain. In order to reduce hazards, follow the instruction for cutting operation; always check the condition of the tool. Do not start the chainsaw directly in a tree.

Fuel Handling

- Be very careful when handling fuels. They are flammable and the vapors are explosive.
- Use only an approved container.
- Never remove the fuel cap or add fuel while the machine is on. Turn off the unit and allow the engine and exhaust components to cool before refueling.
- Do not smoke.
- Never refuel inside a room
- Never store the tool and the fuel tray indoors where there is a naked flame, such as near a water heater.
- If fuel has spilled, do not attempt to start the machine, but rather move it away from the spill before starting to use it. Clean any spills.
- Replace and tighten the fuel tank cap after refueling.
- Follow the instructions in this manual for filling the tool with fuel.

During maintenance and storage

- Stop the tool and wait until it stops. Make sure all moving parts have come to a standstill.
- Allow the machine to cool before performing inspection, adjustments, maintenance, servicing and storage.
- Store the tool where fuel vapor will not reach a flame or spark.
- When transporting and storing, always place the tool in its transport guard and protective device on it.

Causes of rebounds and prevention by the operator

- Bounce may occur when the spout or end of the chain guide touches an object, or when the wood tightens and pinches the cutting chain in the cutting section.
- The contact of the tip may in some cases cause a sudden reverse reaction by bouncing the chain guide up and back towards the operator.
- Pinching of the cutting chain on the upper part of the chain guide can force the chain guide to the operator abruptly.
- Either of these reactions can result in loss of control of the saw likely to result in a serious personal injury. Do not rely exclusively on safety devices built into your saw. As a chain saw user, all measures should be taken to eliminate the risk of accident or injury during cutting.

- Bounce results from improper use of the tool and / or incorrect operating procedures or conditions and can be avoided by taking the appropriate precautions specified below:
- Hold the saw with both hands firmly with the thumbs and fingers encircling the handles of the saw and place your body and arms to allow you to withstand the rebound forces. The rebound forces can be controlled by the operator, if appropriate precautions are taken. Do not allow chain saw to start.
- Do not stretch the arm too far and do not cut above the shoulder height. This helps prevent unintentional end contacts and allows better control of the chain saw in unforeseen situations.
- Use only the manufacturers specified replacement guides and chains. Incorrect replacement guides and chains may cause chain breakage and / or rebound.
- Follow manufacturer's instructions for sharpening and servicing the chain saw. A decrease in the depth gauge level can lead to an increase in rebounds.

Residual risks

Even if you use this product in compliance with all safety requirements, the potential risks of injury and damage remain. The following hazards may arise in the structure and design of this product:

- Always be vigilant when using this product, so you can recognize and manage the risks rather.
- Rapid intervention can prevent serious injury and property damage.
- Turn off and unplug the tool if there are any malfunctions. Have it checked by a qualified professional and have repairs carried out, if necessary, before using it again.
- There are harmful health consequences resulting from the emission of vibrations if the product is used for long periods of time or not properly managed and properly maintained.
- There is risk of injury and property damage due to attachments or broken the sudden impact of hidden objects when using cutting.
- Risk of injury to persons and property caused by flying objects.
- Prolonged use of this product exposes the operator to vibration and can produce so-called "white finger" disease. To reduce the risk, wear gloves and keep your hands warm.
- If any of the symptoms of "white finger syndrome" occur, seek immediate medical attention. Symptoms of the "white finger" include numbness, loss of sensitivity, tingling, tingling, pain, loss of strength, color changes or skin condition. These symptoms usually appear on the fingers, hands or wrists. Risk increases at low temperatures.
- There is a risk of loss hearing when a prolonged use and when a hearing protection is not worn.

Symbols



Symbol warning of a warning



Read and refer to these operating instructions



Wear safety equipment that includes a helmet, protective helmet and protective goggles



Value of sound emission according to European Directive 2000/14 / EC



This tool must be used by persons trained to cut down trees; Read this instruction manual!



The contact of the end of the bar with any object must be avoided.



Do not operate the tool with one hand. Always hold it with both hands.



Wear full protective gear during operation (helmet, boots, goggles, gloves, protective clothing)



Wear gloves of security



Wear security shoes

2. YOUR PRODUCT

a. Description

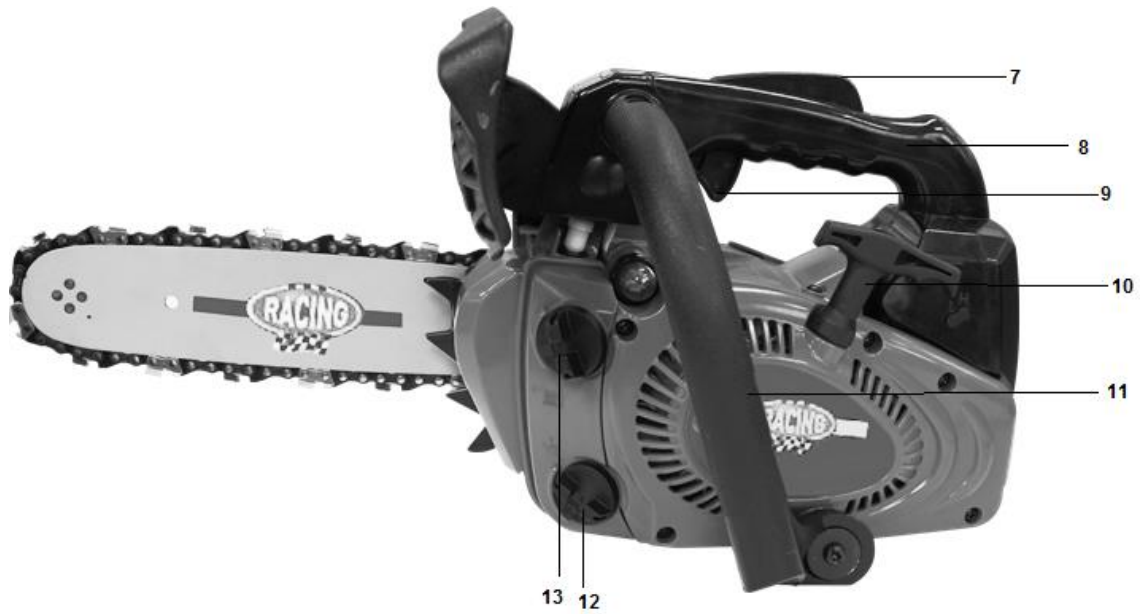
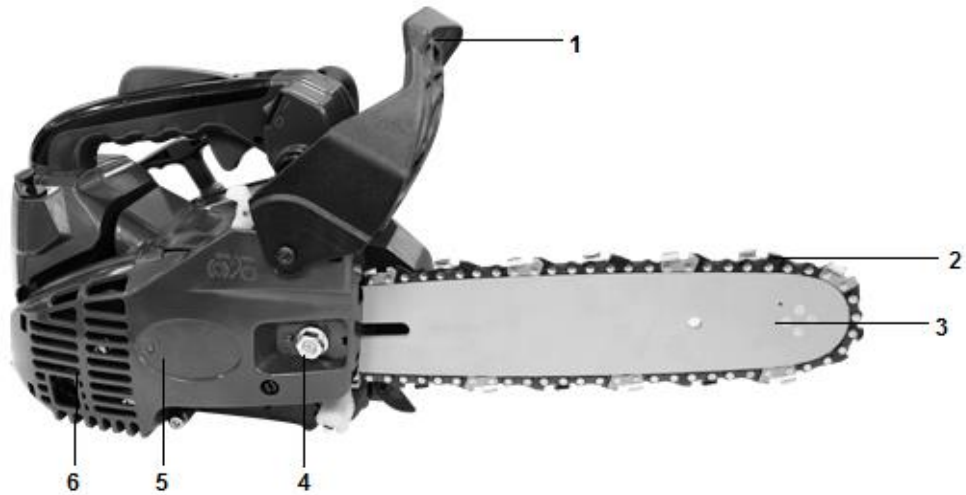

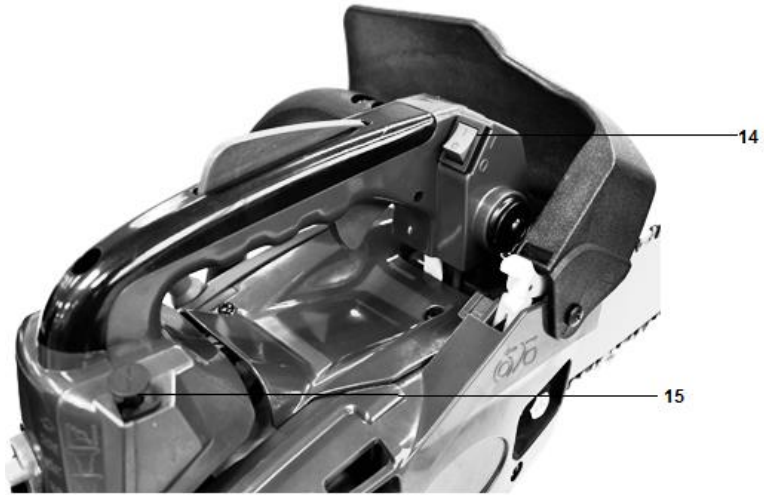

- 1- Safety protection
- 2- Chain
- 3- Chain Guide
- 4- Fastening nut
- 5- Engine
- 6- Ventilation opening
- 7- Safety Trigger
- 8- Handle
- 9- Accelerator throttle
- 10- Cable starter
- 11- Handle
- 12- Oil reservoir
- 13- Fuel Tank
- 14- Switch
- 15- Starter

b. Technical data

Model	RAC2525-1
Type of engine	1E34FC (air cooled 2-stroke petrol engine), Royal Garden.
Fuel Tank Volume	230cm ³
Oil tank volume	160cm ³
Idle speed of the engine	3300±300/min
Clutch speed	4600/min
Maximum power	0.9 kW
Displacement	25.4cm ³
Maximum operating speed	11000/min
Maximum chain speed	21m/s
Maximum motor power	0.9 kW
Maximum engine speed	7500/min
Weight (empty tank, without accessories)	3.5 kg
Cutting length	200mm (10"),
Chain pitch	9,525mm (0,375")
Gauge of chain	1,27mm (0,05")
Type of chain	3/8LP-40 Kangxin
Type of guide bar	AP10-40-509P Kangxin
Sprocket (number of teeth x pitch)	6 teethes 9,525
Carburetor	WT962/Walbro, 1E34FC/Jingke, 1E34FC/Ruixing, MC14B/HLIC
Spark plug	L8RTF/LD, L7T/LD, BM6A/LD, L8RTF/Torch
Sound Pressure level Uncertain K	LpA: 99dB(A) Uncertain KpA=3,0dB(A)
Measured sound power level	LwA : 110.4 dB(A)
Guaranteed power level	LwA : 113dB(A)
Value of vibration	Front handle 9,0 m/s ² Rear handle: 8,5 m/s ² K=1,5m/s ²

3. ASSEMBLY

a. Assembly of the chain guide

IMPORTANT: The machine must not be started during assembly. Wear protective gloves when handling the blade.

- 1) Pull the guard toward the front handle to check that the chain brake is not engaged.
- 2) Loosen the nuts and remove the chain cover.
- 3) Attach the bracket to the rear of the engine assembly with a screw.
- 4) Install the guide and mount the chain on the pinion and guide in the direction shown in the diagram.
- 5) Loosen the nuts and remove the chain cover.
Attach the bracket to the back of the motor assembly with a screw.
Install the guide and mount the chain on the pinion and guide in the direction shown in the diagram.

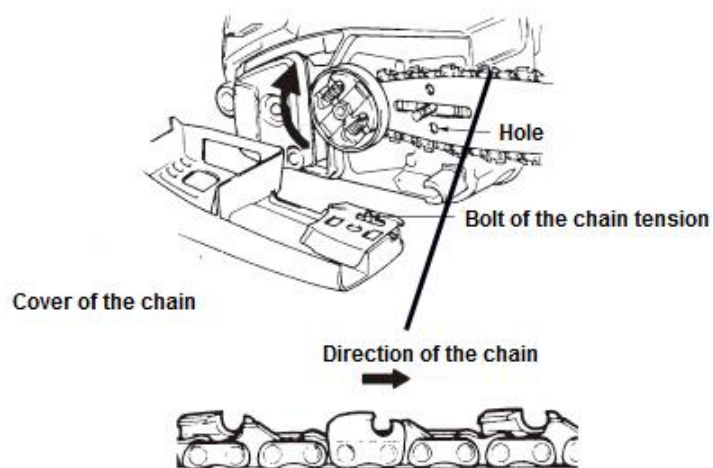

- 6) Adjust the chain tensioning nut in the lower hole of the guide. Then install the chain and secure the mounting nut.

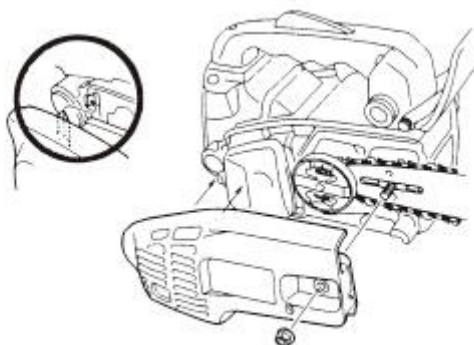

- 7) Adjust the chain tension by turning the tension screw until the straps touch just the bottom side of the bar.

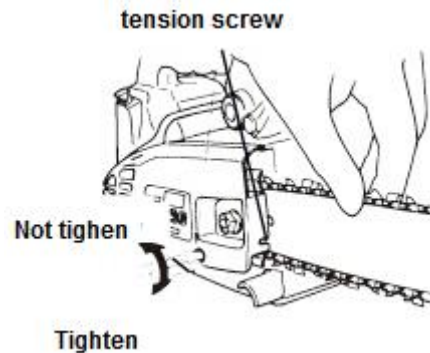

- 8) Tighten the nuts and check if the chain is rotated correctly and tight.

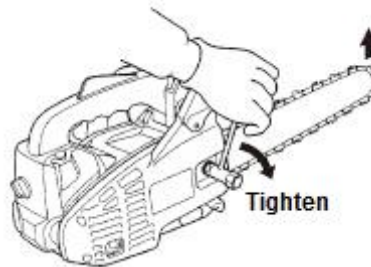

While lifting the chain guide, turn the content screw to apply correct tension to the chain.

Then lock the crankcase nuts.

Rotate the chain with your hand to check that it is turning without excessive resistance and that it is properly tightened.

Repeat the installation if the chain is not tight.

b. Adjusting the chain tension

The tool motor must be switched off before adjusting the chain tension.

Make sure that the chain is inside the groove of the guide. Hold the guide by its tip. Adjust the tension of the chain with the tension adjustment screw until the chain teeth touch the bottom of the guide.

Turn the chain tension adjustment screw clockwise until the chain is tight. Do not stretch the chain too much. Check the tension of the chain and check if the casing is properly tightened. If this is not the case, please repeat the procedure.

4. FILLING THE FUEL TANK

WARNING: When filling the tank:

The chainsaw must always be stopped and cooled.

Never smoke during refueling. It must not have flames or sparks near the fuel.

Before refueling, allow the chainsaw to cool completely. Do not attempt to refuel when the engine is hot.

If fuel has been spilled, immediately stop refueling and do not start the engine. Clean up the spill and fill the machine in another location

Never fill the fuel tank to the flange; there is a risk of overflow.

Do not refuel in a closed and unventilated area.

The fuel used for this tool is a mixture of unleaded gasoline and registered engine lubricant. When mixing gasoline with oil, use only gasoline that does not contain ethanol or methanol. Unleaded gasoline is a quality gasoline type. This will help to avoid damaging the fuel lines of the engine and other engine parts.

The recommended mixing ratio is 40:1 (make sure the mixing ratio is correct before filling the product.

a. Mixing

- Mix in a clean, empty container (supplied).
- Pour the oil into the container.
- Pour the fuel into the tank. Mix the mixture long enough (more than one minute) to get a good combination.

b. Filling the fuel tank

- Unscrew the fuel tank cap and remove it.
- Fill the tank slowly with the mixture. Do not exceed the maximum capacity (fill to 80% of its capacity preferably).
- Replace the cap on the fuel tank and tighten it
- Wipe any spillage around the unit if necessary

Note: To avoid damage and accidents, DO NOT USE OTHER MIXTURES AND OTHER TYPES OF OIL / PETROL

c. Storage of fuel

The fuel must be kept in a clean and safe container and always closed.

If you are not using the product for a long time, remove the fuel mixture and add it to a container.

Do not leave the fuel for a long time in the product. The fuel may clog the carburetor and the engine will not operate properly.

d. Disposal of fuel

When the fuel is no longer used or worn, please dispose of it in an authorized location. Check local laws regarding disposal of fuels

5. OPERATION

Before using the chainsaw, inspect the work area. This must be cleared. Remove any branches, obstacles and other items that may cause damage during cutting. The unit should always be filled with fuel and useful. Check the level of filling and refill when necessary.

IMPORTANT: starting shall always be done with the chain brake activated. See on page 14 and 15 how to achieve this.

1. Starting the engine

- a. Press the priming pump continuously until the fuel enters the pump. Set the switch to position I.

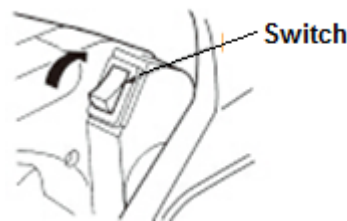

- b. Pull the starter button. The starter will close and the throttle will be moved to the starting position

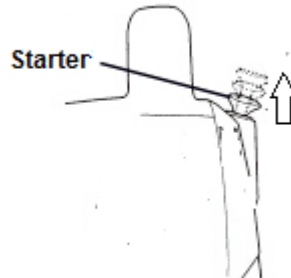

Hold the chainsaw firmly against the ground. Put the chainsaw:

- Either on the left side of your body holding the handle firmly with your left hand. Use your right hand to pull the starter rope
- Either on the right side of your body holding the handle firmly with your right hand.

Use your left hand to pull on the starter rope.

In both cases, the saw must remain away from the operator's body.



2. Stopping the engine

Allow the chainsaw to run for a few minutes. Then turn the switch to the OFF position.

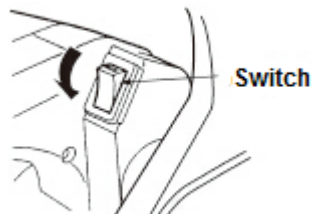

3. Main settings

a. Adjusting the carburetor

The carburetor is preset at the factory. To avoid malfunction, it is recommended not to adjust the adjustment screws. If these screws require readjustment, have the machine serviced by your service center.

Stop the tool and tighten the needle L until it stops. Do not force it. Then set it to its initial number of turns as shown below. The number of turns for the needle is also shown below:

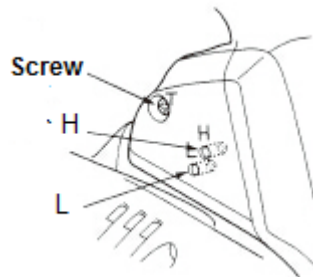

b. Chain brake

The chain brake is a device that automatically stops the chain in case a backward movement occurs, causing the saw to jump. Normally, the brake is automatically activated by the inertia force.

It is also manually tightened by pushing the brake lever down and forward. When the brake is running, a yellow sign comes out from the base of the brake lever.

To release the brake, pull the brake lever up until it clicks into place. When the brake is working, release the throttle lever to slow down the engine speed. Continuous use when the brake is running causes the clutch to heat up and can cause problems.

When checking the machine before using it, check the operating condition of the brake by performing the following operations:

- Start the engine and grasp the handle firmly with both hands.
- While pulling the throttle control lever to keep the chain in operation, push the brake lever down with the back of the left hand.
- When the brake is running and the chain is stopped, remove the hand from the throttle.
- Loosen the brake.

c. **Release of the chain brake**

To use the chain saw again, the chain brake must be released. This must be done machine off and cooled. Pull the shield until it returns to its original position.

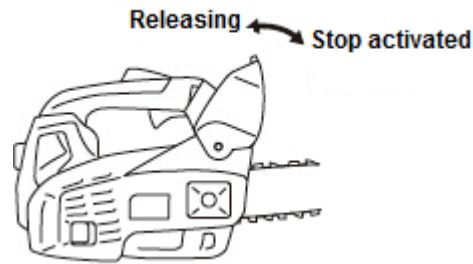

d. **Sharpening of the chain**

For best performance, we strongly recommend that you periodically sharpen the chain. The chain can either be sharpened by a professional or by yourself by providing you with a sharpening guide (make sure you know how to use it).

The chain must be sharpened when:

- Wood chips have become powder
- To make a normal cut, force on the tool
- The cut is not straight
- Vibration increases
- Fuel consumption has increased

e. **Checking the lubrication of the chain**

- Before checking the oil, make sure that the bar and the chain are in place.
- Once the engine is started, turn it at medium speed and check that the chain oil is sprayed and traces off the ground.
- The oil flow of the chain is adjustable to obtain the proper flow. Insert a screwdriver on the clutch side.
- Turn the adjuster to obtain the correct flow rate for the job.
- The chainsaw must essentially consume the contents of the oil tank between each full of fuel. Do not forget to fill the oil tank when filling the machine with fuel.

4. **Work with wire and harness**

NOTE: It is necessary to have a complete training before working at high. It is strongly recommended that only experienced and trained persons carry out work at high. Know all emergency procedures to be carried out.

These instructions are examples of good practice. Follow and abide by local laws and regulations as well.

It is also recommended that the operator who is going to work at height be assisted by another person.

It is compulsory with techniques of climbing and working position. Be equipped with complete equipment including harnesses, ropes, strops, snap hooks and other equipment that allows them to maintain and maintain the saw by adopting secure positions.

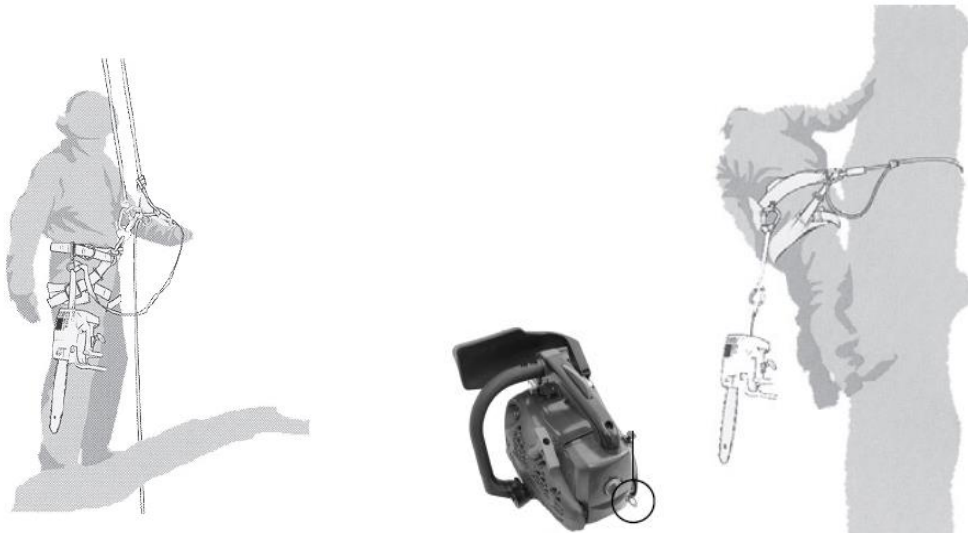

a. Using the Chainsaw in the Tree

An analysis of accidents with chainsaws during tree pruning shows that the main cause is an inadequate use of the one-hand chainsaw. In a large majority of accidents, operators do not seek to adopt a safe working position that allows them to hold with both hands. This results in an increased risk of injury due to:

- The absence of a firm grasp of the chainsaw in case of rebound
- A lack of control of the chainsaw, which is more likely to come into contact with the climbing ropes and with the operator's body (especially the hand and the left arm) and
- Loss of control due to unsafe working position, resulting in contact with the chain saw (unexpected movement during operation of the chain saw).

b. Safe positioning for two-hand operation

In order to allow operators to hold the chain saw with both hands, it is generally recommended that they aim for a safe working position when operating the chain saw:

- At the hip, when cutting horizontal sections, and
- At the level of solar plexus, when cutting vertical sections.

When operators work near vertical trunks with low lateral forces on their working position, good support may be sufficient to maintain a safe working position. However, as operators move away from the trunk, they will need to take steps to suppress or neutralize increasing lateral forces, for example by redirecting the main rope through an additional anchor point or using an adjustable strap directly from the harness Has an additional anchor point.

The obtaining of a good support to the working position can be favored by the use of a foot stirrup created by an endless sling.

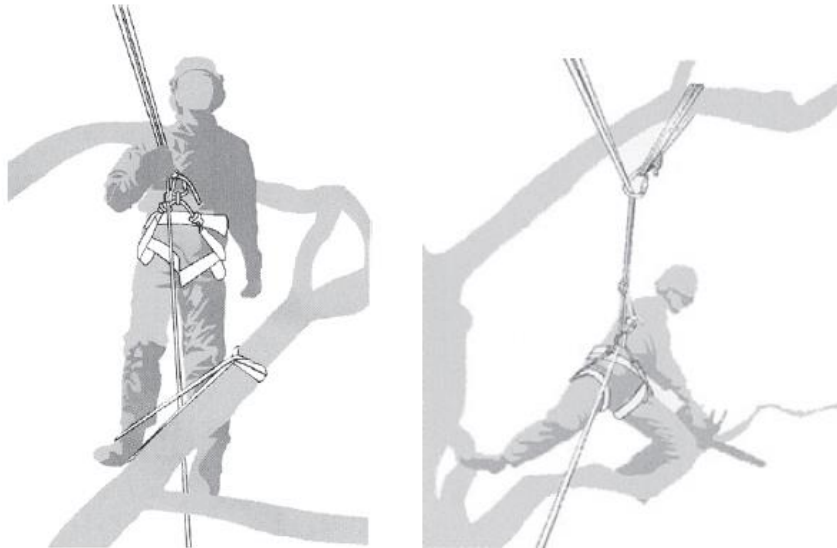

c. Starting the saw in the tree

When starting the saw in the shaft, the operator should:

- Apply the chain brake before starting, and
- Hold the saw on the left side, either on the right side before starting:
 - On the left side, hold the saw with your left hand on the front handle while holding the saw away from the body while pulling the starter rope with your right hand, or
 - On the right side, hold the saw with your right hand on one of the two handles while holding the saw away from the body while pulling the starter rope with your left hand.
- The chain brake should always be engaged before lowering a running saw to its stroke.
- Operators should always check that the saw has sufficient fuel before undertaking critical cuts.

d. Using the chain saw with one hand

Operators should not use chain saws to prune single-handed trees when they are in an unstable working position and prefer hand saws when cutting wood of small diameter at the ends of the branches.

Only chainsaws should be used for tree pruning with one hand when:

- Operators cannot maintain a working position allowing them to use both hands
- They need to maintain their working position, allowing them to use both hands
- The saw is used in full extension, perpendicular to the body of the operator and separated from it.



Operators should:

- Never cut with the rebound area at the end of the chain saw chain guide
- Never hold and cut sections or
- Never try to catch sections when they fall.

e. Release of a jammed saw

If the saw gets stuck during cutting, the operators should:

- Saw the saw and attach it securely to the cutting foot of the shaft (ie trunk side) or has a separate chord from the tool
- Pull the saw of the cluster while the branch is lifted, if necessary,
- If necessary, use a hand saw or a second chainsaw to release the chain saw.

5. Cutting work

The tool should only be used to cut trees. Do not use it for other applications. Do not attempt to remove the chainsaw when it is stuck during operation. Stop the machine and remove the wedge blade with a wedge.

Stick your feet well, keep a good balance and do not climb on the tree trunk.

Try not to work on a slope. However, if you have to work on a slope, always stand higher than the tree trunk.

Before bending a branch or trunk in bending, observe the direction of bending and finish the cut opposite the bending side to prevent the chain guide from getting stuck in the cut.

a. Felling of trees

Examine the work area and estimate where the tree will fall. Start the machine as described above. Start by making a notch in the direction of fall chosen. When the tree falls, shout or make a beep to alert people in the vicinity. When the shaft falls, move away from the cutting area.

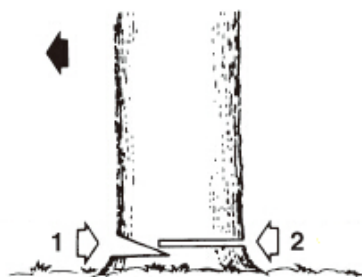

b. Trunk on the ground

Cut half of the trunk, turn it over and finish the cut on the other side.

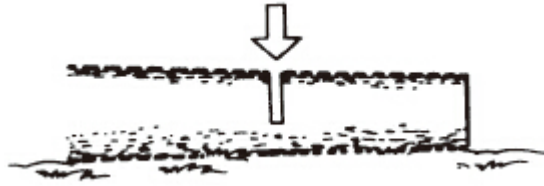

c. Trunk in elevation

Begin by cutting a first part from below and then from above. Then, on the second part, repeat this operation.

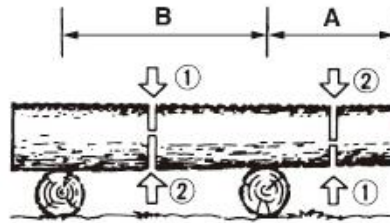

f. Pruning of a felled tree

Observe first the direction of flexion of the branch. Make a first notch on the side in flexion and finish the cut on the opposite side.

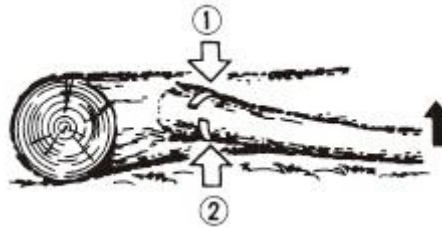

g. Pruning a tree

Begin pruning by nicking the tree from below and then finish at the top.

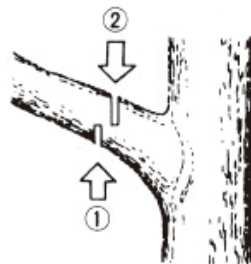

6. MAINTENANCE AND STORAGE

1. Maintenance

Before any maintenance work, the machine must be switched off and completely cooled.

Perform the maintenance work according to the instructions below and perform them regularly. A clean, well-maintained machine increases its standard of living and efficiency. On the contrary, a machine maintained can cause damage, accidents and render the tool inoperable in the short term.

Any other maintenance, modification or repair work must be carried out by a qualified professional.

Do not immerse the tool in water or any other liquid.

a. After each use

- Clean the engine block louvers with a blower.
- Check the chain brake if it is working properly.
- Clean the plastic parts before wiping with a damp cloth.
- Check the use of the chain guide
- Check the auto lubrication circuit if it is obstructed or not.
- Check sprocket condition
- Clean the cylinder fins with a compressor

b. Cleaning the air filter

Use a compressor to blow dust and chips.

To clean the filter foam: open the air filter, remove the foam. Clean this foam with gasoline, wring out and dry. Replace the foam in the air filter and reassemble as described in the diagram.

After 10 uses, replace the foam with a new one.



c. Cleaning the oil inlet

Disassemble the chain guide and the chain hood and check that the oil supply is clean. If dirty, remove dirt with a clean compressor or cloth.

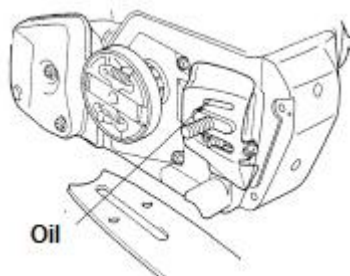

d. **Cleaning the oil filter and fuel filter**

Clean these items regularly. Remove them from the tanks using clamps. Clean them with gasoline and then put them back in place afterwards

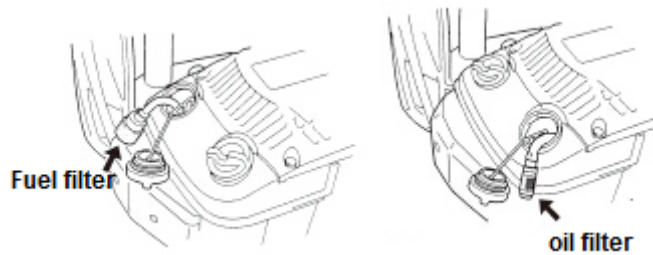

e. **Guide bar**

Cleaning: Remove bar guide to remove dirt from grooves and oil inlet. Regularly grease the pinion.

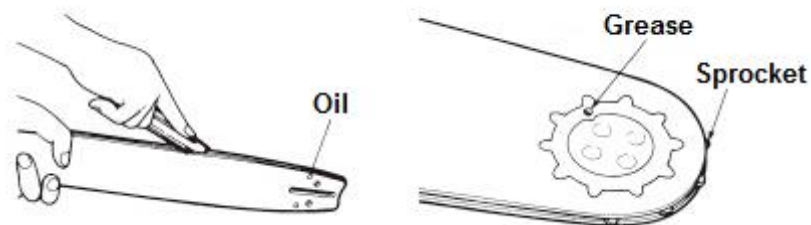

Check: Reverse the bar from time to time to avoid the effects of wear. The bar rail should always be in place. Use a ruler to observe it. If a gap is observed between them, then the rail is normal. Otherwise, the rail is worn out. A bar must be corrected or replaced.

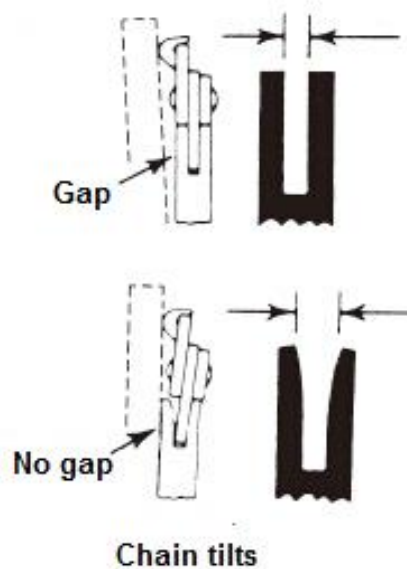

f. **Sprocket**

Check the sprocket on signs of wear. If wearing is important, replace it with a new one. Do not install a chain on a worn or damaged sprocket. Do not install a worn chain on a pinion.

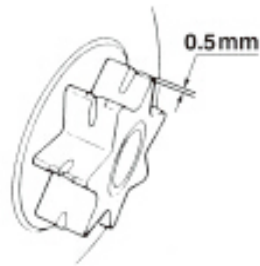

g. **Spark plug**

Clean the electrodes with a wire brush and set the gap to 0.6mm if necessary.

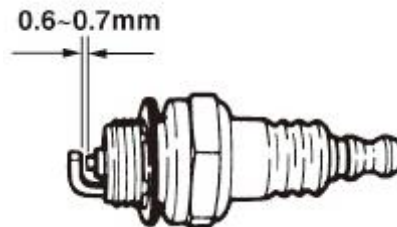

h. **chain saw**

Check each time the cutter and cutting angles are as shown below.

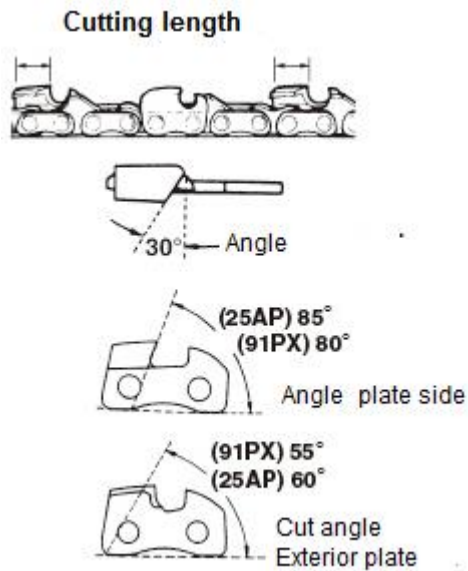

i. **Sharpening of the chain**

For best performance, we strongly recommend that you periodically sharpen the chain. The chain can either be sharpened by a professional or by yourself by providing you with a sharpening guide (make sure you know how to use it).

The chain must be sharpened when:

- Wood chips have become powder
- To perform a normal cut, force on the tool#
- The cut is not straight
- Vibration increase
- Fuel consumption has increased
- Sharpening method:

The chain saw must be switched off and locked before sharpening. Use a round file or sharpening device (see in store).

Place the file on the tooth and push straight. Shift with the same movement.

After sharpening all teeth, check if the teeth are sharp.

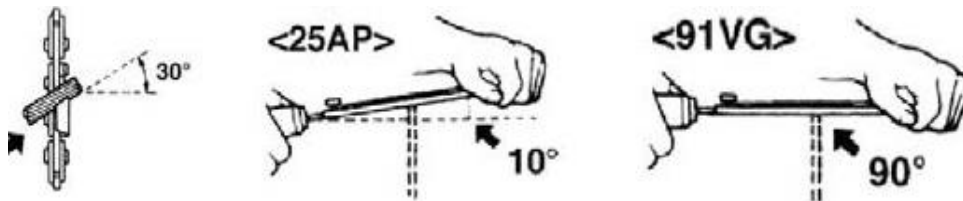

2. **STORAGE**

When storing, the tool must be turned off, cooled, emptied of fuel and thoroughly cleaned. Store the tool in a dry, clean place, preferably in its packaging, and out of the reach of children. Store all accessories and other items with the tool

7. DECLARATION OF CONFORMITY

Declaration of conformity
BUILDER
ZI, 32 rue Aristide Bergès – 31270 Cugnaux - France

Declares that the machinery designated below:

Petrol chainsaw
RAC2525-1
Serial number:

Complies with the provisions of the Directive "machinery" 2006/42/EC and regulations
National transposing it;

Also complies with the following European directives:

EMC Directive 2014/30/EU
RoHS Directive 2011/65/EU
Noise emission Directive 2000/14/EC Annex V and Directive 2005/88/EC

Measured sound power level	LwA : 110.4 dB(A)
Guaranteed power level	LwA : 113dB(A)

Also complies with European standards, national standards and provisions following
techniques:

EN ISO 11681-2: 2011
EN ISO 14982: 2009

EC-type certificate number 11SHW2317-05
Notified body under 0905

Intertek Deutschland GmbH,
Stangenstraße 1,
70771 Leinfelden-Echterdingen

Responsible of the Technical file: Mr Patriaca

Cugnaux, le 18/10/2018



Philippe MARIE / PDG