

HYUNDAI
POWER PRODUCTS

**ROBOTIC LAWN MOVER
TONDEUSE ROBOT**

HTDER1821V

INSTRUCTIONS ORIGINALES

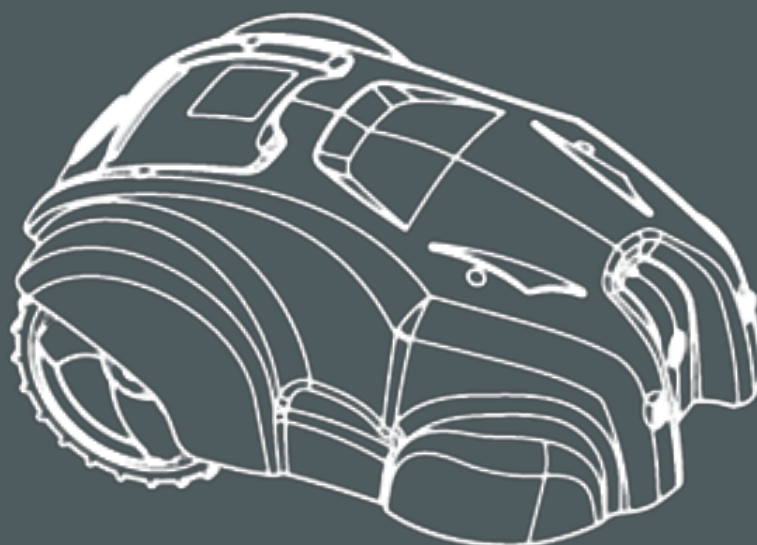

1. Introduction and safety

WARNING! Before using your tool, please read this manual carefully and understand the instructions. Please keep these instructions for future use. If you give this tool to a third party, please also give this manual.

- Failure to comply with these safety rules is not only dangerous, but also voids the warranty conditions.
- Never allow children, persons with reduced physical or sensory or mental abilities, or no experience or knowledge, or persons unfamiliar with these instructions to use this machine. Local laws may restrict the age of the operator.
- Children should not close to the machine when it is in use.
- Do not let children play with this machine, whether it is in operation or not.
- Please ensure that the machine is in good working order. In case of damage or defect, do not use the tool and have it repaired by a qualified service.
- Never turn the mower on if it is turned over or if it is not in the working position.
- Switch off the machine when:
 - o You do not use it,
 - o When left unattended,
 - o When performing an intervention on the machine,
 - o When the battery fails,
 - o During maintenance work,
 - o When you transport the machine from one place to another.
- Keep children and animals out of reach of the machine.
- Before working, inspect the work area; remove any cables, stones, debris and any objects / materials from the area to be mowed that could cause an accident and damage.
- Avoid using the mower to cut grass that is not on the ground, for example, grass growing on walls or rocks, etc.
- In the presence of flammable and / or explosive substances such as liquids, gases and powders.
- The operator is responsible for any damage caused to third parties within the work area.
- Mow only in daylight or with adequate artificial light.
- If you do not use the mower, store it in a dry place out of the reach of children.
- The mower must be used in accordance with these instructions and only in a vertical position relative to the ground. Any other position is forbidden because dangerous.
- Check regularly that the screws are correctly tightened.
- Before using the appliance and after any impact, check for signs of wear or damage and have the tool repaired if necessary.
- Never use spare parts or accessories not supplied or recommended by the manufacturer.
- Never allow children, persons with reduced physical, sensory or mental abilities or lacking experience or knowledge, or persons unfamiliar with these instructions to use this machine.
- Never use this machine when people, especially children or animals are nearby.
- Never replace non-metallic cutting means with metal cutting means.
- Do not touch dangerous moving parts before stopping the unit completely.
- Do not use the tool without guards.

- Never replace non-metallic cutting elements with metal cutting elements.
- Do not expose the tool to rain or moisture.
- Do not use the tool when there is a risk of thunderstorms and lightning. Do not use the tool when weather conditions are poor.
- Do not insert metal objects into the charger or the battery connections, as this may cause a short circuit or be a source of danger.
- When the mower is in operation:
 - o Do not open it and do not disassemble it
 - o Do not carry repairs
 - o Do not lift it
 - o Do not check the blade
- Any inspection, repair, maintenance must be done completely off machine.
- Do not use the mower on slopes of more than 30 degrees max.
- Do not use the mower when its safety device is damaged.
- When the machine is no longer used, turn off the main switch and keep the appliance in a place out of the reach of children, to avoid damage to children or the lawn mower.
- The battery should always be charged when using the mower.
- Always use the battery and charger supplied. Do not use or mix these elements with other similar products. Incorrect use may result in electric shock, overheating, or leaking corrosive liquid from the battery.
- Never use the mower when it is raining. Do not expose it to water and moisture. Do not leave it outside during the night. Avoid cutting wet or damp grass.
- Familiarize yourself with the controls and proper use of the equipment.
- After the operation, perform the maintenance of the tool. Carefully follow the instructions in the chapter "Care and maintenance". These instructions will help keep the tool in good condition.

IMPORTANT
READ CAREFULLY BEFORE USE
KEEP FOR FUTURE REFERENCE

Safe operating practices

Training

- a) Read the instructions carefully. Be familiar with the controls and the proper use of the machine.
- b) Never allow people unfamiliar with these instructions or children to use the machine. Local regulations may restrict the age of the operator.
- c) The operator or user is responsible for accidents or hazards occurring to other people or their property.

Preparation

- a) Ensure the correct installation of the automatic perimeter delineation system as instructed.

- b) Periodically inspect the area where the machine is to be used and remove all stones, sticks, wires, bones, and other foreign objects.
- c) Periodically visually inspect to see that the blades, blade bolts and cutter assembly are not worn or damaged. Replace worn or damaged blades and bolts in sets to preserve balance.
- d) On multi-spindle machines, take care as rotating one blade can cause other blades to rotate.

Operation

General

- a) Never operate the machine with defective guards, or without safety devices, for example deflectors and/or grass catchers, in place.
- b) Do not put hands or feet near or under rotating parts. Keep clear of the discharge opening at all times.
- c) Never pick up or carry machine while the motor is running.
- d) Remove (or Operate) the disabling device from the machine
 - Before clearing a blockage;
 - Before checking, cleaning or working on the machine.

Additionally when the machine is operating automatically

Do not leave the machine to operate unattended if you know that there are pets, children or people in the vicinity.

Additionally when using the manual controller

- a) Mow only in daylight or in good artificial light.
- b) Avoid operating the machine in wet grass.
- c) Do not operate the machine when barefoot or wearing open sandals. Always wear substantial footwear and long trousers.
- d) Always be sure of your footing on slopes.
- e) Use extreme caution when reversing the machine towards you.
- f) Always switch on the motor according to instructions with feet well away from the blade(s).

Maintenance and storage

- a) Keep all nuts, bolts, and screws tight to be sure the machine is in safe working condition.
- b) Check the grass catcher frequently for wear or deterioration.
- c) Replace worn or damaged parts for safety.
- d) Ensure that only replacement cutting means of the right type are used.
- e) Ensure that batteries are charged using the correct charger recommended by the manufacturer.

Incorrect use may result in electric shock, overheating or leakage of corrosive liquid from the battery.
- f) In the event of leakage of electrolyte flush with water/neutralizing agent, seek medical help if it comes into contact with the eyes, etc.
- g) Servicing of the machine should be according to manufacturer instructions.

Additional instructions

1. Congratulations on the purchase of this exceptional quality product. For best results with your mower, read all of these features. This user manual contains important information regarding the specifications of this product, its installation and use.
2. Read this user manual carefully before using the automatic mower.
3. The mower may be damaged if not used properly.
4. Do not modify the original design of this mower. Any changes to this instruction manual will damage the mower and may cause accidents.
5. Check for stones, branches, tools, toys and other objects on the lawn that may damage the blades and stop the mower.
6. Never use a pressure washer or water to clean the mower.
7. Do not sit on the mower and do not use it as a means of transportation. Children and pets should be kept away from the lawn mower.
8. Turn off the mower before lifting or transporting it.
9. **WARNING** - Never allow children, people with reduced physical, sensory or mental abilities or lack of experience and knowledge or persons unfamiliar with these instructions to use the machine, local regulations may restrict the age of the operator;
10. **WARNING** - Do not allow children to be near or play with the machine during operation.
11. **WARNING** - Do not use the machine to create a hazard. Only use a machine in good working order, on grass, with a work area free of obstacles.
12. Persons who are inexperienced and/or have no knowledge of the instructions should not use this automatic mower (to avoid serious injury)
13. Do not place anything on the mower or its signal generator.
14. Do not operate the mower with defective or damaged components such as blades, screws, nuts, etc.
15. Never put your hands and feet under the mower.
16. The mower does not guarantee full compatibility between the mower and other types of wireless systems such as remote controls, radio transmitters, electrified fences, etc.
17. Start the mower according to these instructions.
18. It is recommended that the cutting height be less than 7cm.
19. It is forbidden to use the mower on a lawn with a slope of more than 30 degrees.
20. Turn off the power before cleaning.
21. Carefully read all warnings on the machine, the battery, the signal generator and in this manual.
22. Turn off the mower before transporting or repositioning.
23. Carry the mower by the handle at the back under the mower. Carry the mower with the blade disc away from the body.
24. Do not lift the mower by the outer protective case.
25. Turn off the mower and make sure it is completely shut down before performing any maintenance and cleaning.
26. Inspect the mower weekly and have damaged or worn parts replaced, such as blades or brushes. Any replacement of parts and accessories must be done by the manufacturer or an authorized after-sales service.

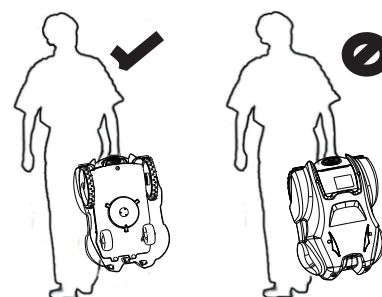

27. CAUTION: Do not touch the rotating blade. The blade must stop completely before handling.
28. Always check the baffle condition to keep the material discharge chute clean and unhindered.
29. Never run using the machine or its peripherals;
30. Always use the battery supplied with this machine. In case of replacement, contact your dealer or the manufacturer for the type (s) of batteries that can be used with this machine.
31. Stop the machine by pressing the STOP button when you need to:
 - remove a blocked item
 - check, clean or work on the machine.
 - Inspect the machine for damage after striking a foreign object.
 - Check the machine if it starts to vibrate abnormally. Check the damage before restarting;
32. The boundary wire must be disconnected from the docking station if it is damaged or intermingled. The mower must be extinguished before the power plug of the adapter must be removed from the wall outlet.
33. Avoid using the machine and its peripherals in bad weather, especially in case of lightning, thunderstorms and generally in bad weather.

Residual risks

Even if you use this product in compliance with all safety requirements, the potential risks of injury and damage remain. The following hazards may occur in the structure and design of this product.

There is a risk of injury and damage to property due to attachments or broken the sudden impact of hidden objects when using cutting.













Risks of damage to personal injury and property, which caused are by flying objects. To reduce residual risk, always inspect the work area, wear safety shoes and protective equipment.

Intended use

This mower model is designed for mowing natural grass. Any other use is prohibited. It is only suitable for private use in a garden or a plot. Lawn mowers designed for private plots or gardens are those used for the maintenance of grassy areas and private lawns.

WARNING - These types of mowers should not be used in public areas, parks, sports, agricultural or forestry areas.

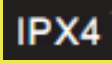
Symbols

	<p>WARNING - Read instruction manual before use the tool</p>
	<p>WARNING - Risk of projections. Keep bystanders away</p>
	<p>In conformity with CE, RoHS</p>
	<p>WARNING - Sharp tines. Beware of cutting fingers or toes. Press the STOP button before working or lifting the machine. Read the instruction manual</p>
	<p>WARNING - Keep feet and hands away from rotating blades. Do not ride on this machine or use it as a means of transportation</p>
	<p>Avoid disassembling and reassembling this unit. These operations must only be performed by qualified persons.</p>
	<p>Do not repair yourself. Any intervention must be done by a qualified service</p>
	<p>Never perform maintenance or debugging on this device without wearing personal protective equipment (PPE)</p>
	<p>CAUTION - Do not touch the rotating blades.</p>
	<p>Symbol for recycling</p>
	<p>Class III protection</p>
	<p>Degree of protection: IPX4</p>
	<p>Guarantee sound power level</p>

2. Main units and Accessories

2.1 Four main units

This section contains information you should be aware of when planning to install the robotic mower.

2.1.1. Robotic Mower:

An automatic lawn mower that mows the lawn by moving in an irregular pattern, the mower is powered by a rechargeable battery.

2.1.2. Signal Generator:

Be connected between boundary wire and power adapter.

2.1.3. Boundary Wire:

Be buried in a loop around mower's working area. The boundary wire is buried around the edges of the lawn and around objects and plants that the mower must not run into. The wire is also used for guide wires to find station.

2.1.4. Power adapter:

Be connected between the signal generator and a 120V (230V) wall sock. The adapter is connected to the wall socket via an integrated power cord and to the signal generator .

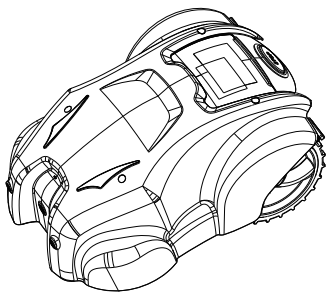

1

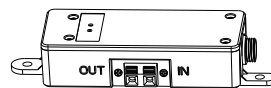

2

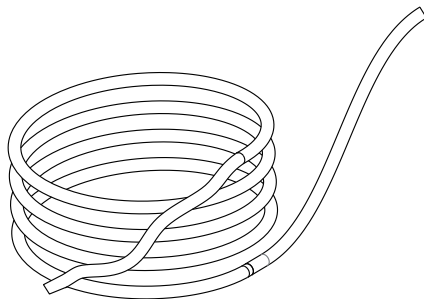

3

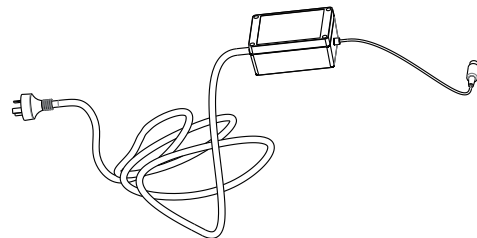

4

2.2. Knowing Robotic Mower and Accessories

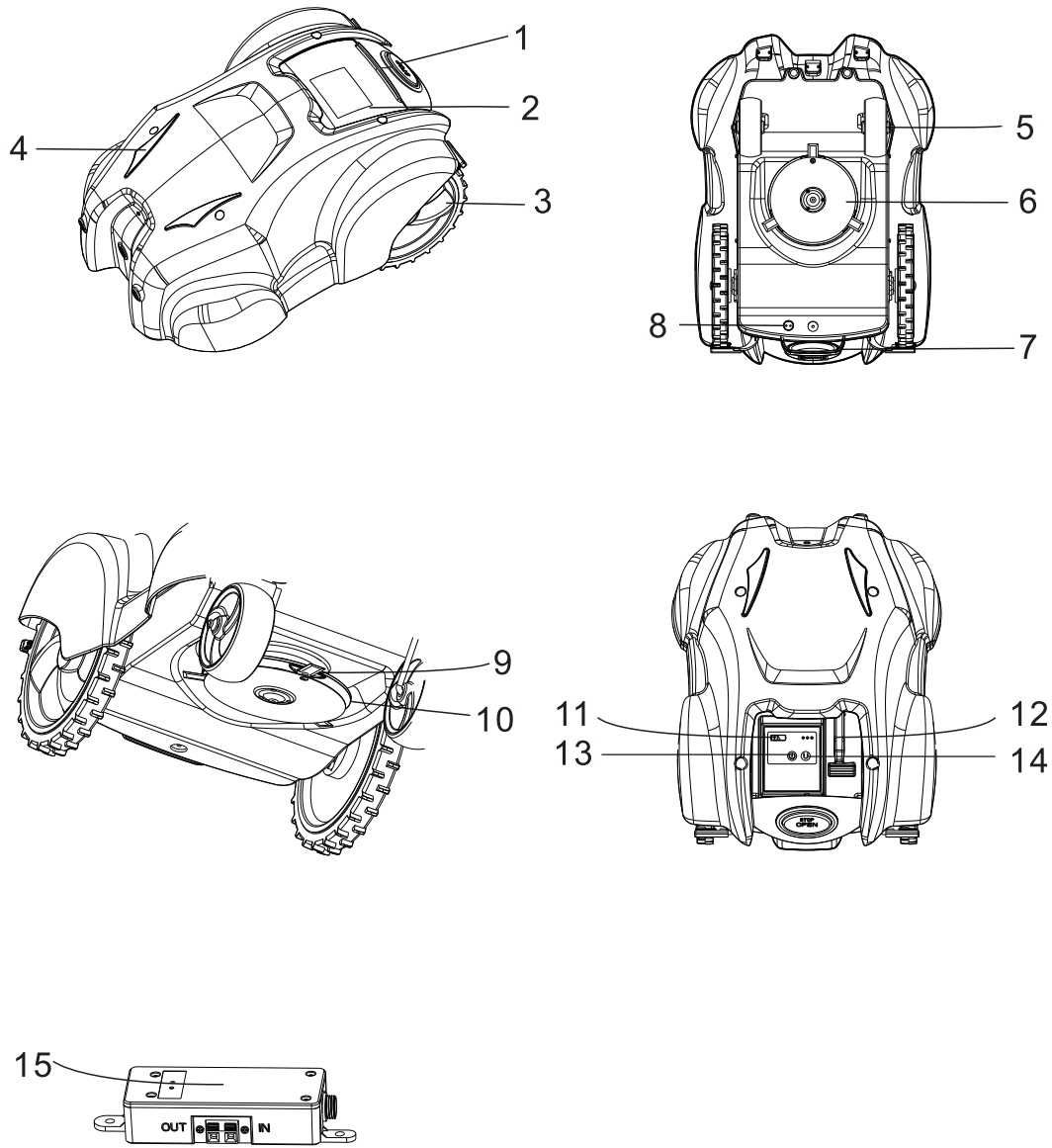

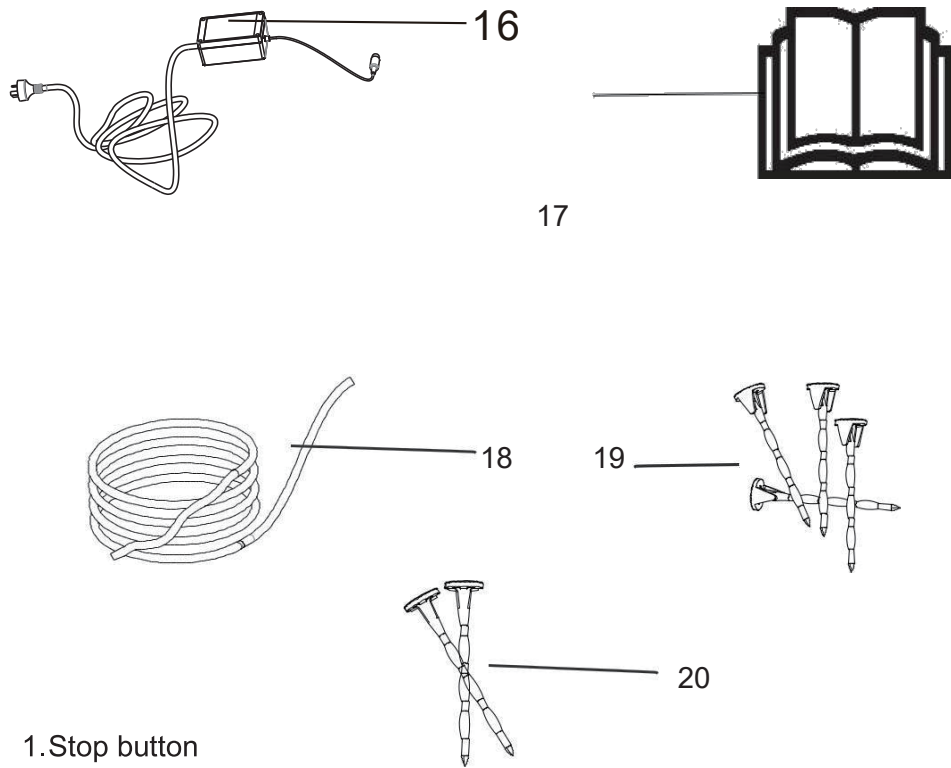

1. Stop button
2. The control panel cover
3. Drive wheel
4. Charging strip
5. Front wheel
6. Protect plate
7. Handle
8. Charge
9. Blade
10. Blade Plate
11. LCD display
12. Cutting height adjustment
13. Power switch
14. Sonic switch
15. Signal Generator
16. Power adapter
17. Operator's Manual
18. Boundary wire
19. Staples for boundary wire
20. Nails

3. Function of Mower

3.1 Capacity

Robotic Mower is recommended for lawns up to 500 m².

The maximum mown area depends on the condition of the blades and the type of grass, growth rate, humidity and the shape of the garden.

How long mower mows and recharges can vary due to the ambient temperature. Up to about 25, one battery fully charged mower mows for approximately 100 minutes depending on the age of the battery and the thickness of the grass.

3.2 Mowing technique

1. The mowing way used by mower is based on an effective and energy efficient components. We recommend you allow mower to mainly mow in dry weather to obtain the best possible effect.
2. Mower can mow in the rain, you may fix wheel brushes to keep the drive wheels clean and increase traction.
3. When there is a risk of thunder mower should not stand in the Dock station.
4. When there is a risk of a thunder storm, the adapter plug should be removed from. The socket and the perimeter wire disconnected from the Dock station.
5. The blades must be in good condition to obtain the best mowing effect.

In order to keep the blades sharp for as long as possible, it is important to keep the lawn free from branches, small stones and other objects.

3.3 Working method

1. Mower automatically mows the lawn. It continuously combines mowing and charging.
2. The signal generator sends out a signal that mower can sense. The mower starts to search for the signal generator when the battery power becomes low. Mower does not mow when it is searching for the signal generator.
3. When there is a big object (such as human, big tree etc.) higher than 20cm in front of mower, the mower can avoid hit it and reverses and selects a new direction.
4. When mower body hits an obstacle higher than 13cm, the mower reverses and selects a new direction.

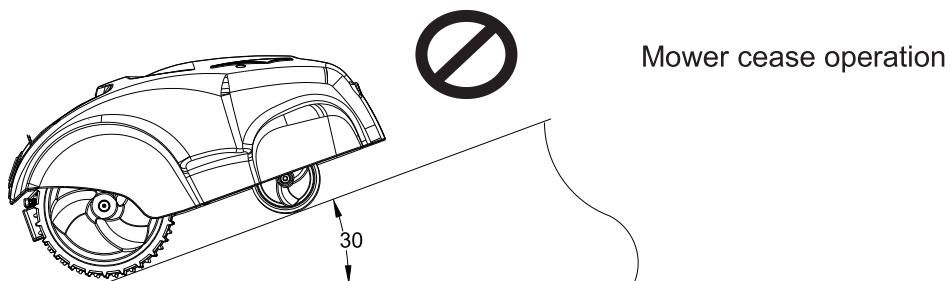
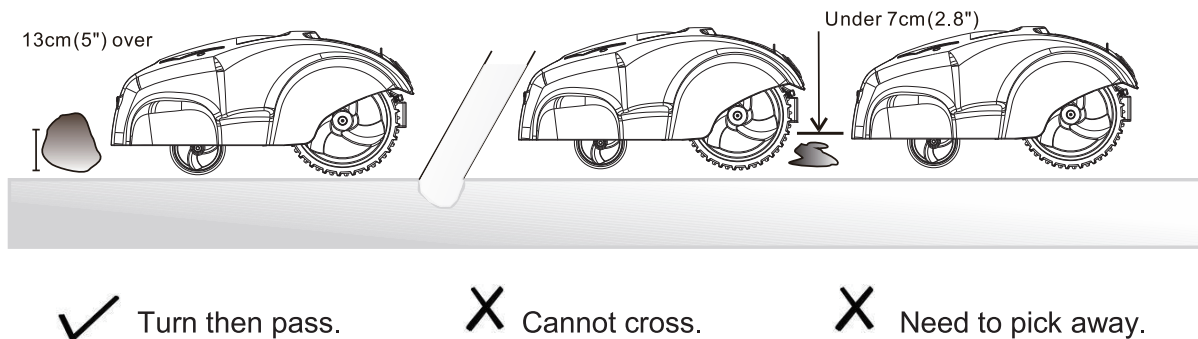

5. When the rain is too heavy, the Mower may stop working and return to signal box.
6. If the slope is steeper than 30 degree, the mower may cease operation and mowing motor will stop in one minute.
7. When the mower is operating, if user holds the handle, the mower will stop, and the mowing motor will stop in one minute.

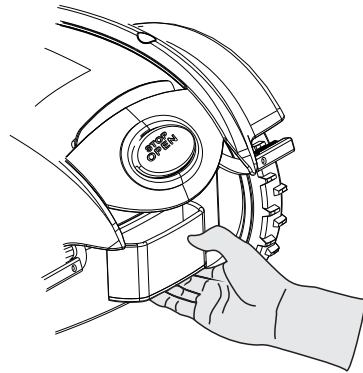

Handle Sensor

8. The **OPEN/STOP** button in the back of mower is used to stop the mower when it's running. Pressing the bottom will also open the control panel cover, if you need to get the mower back to work, you must close the cover.

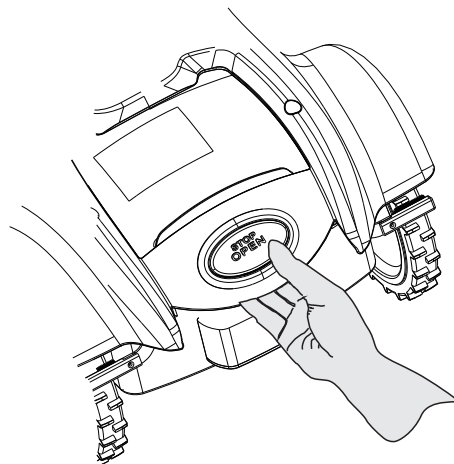

Open /Stop Button

9. Under the control panel cover, there is a control panel, it is used to manage all the mower settings.
10. If you power on the mower, you must close the cover, then the mower will start performing requested actions.
11. If the cover is left open after power on, the mower will automatically power off after 6 minutes.

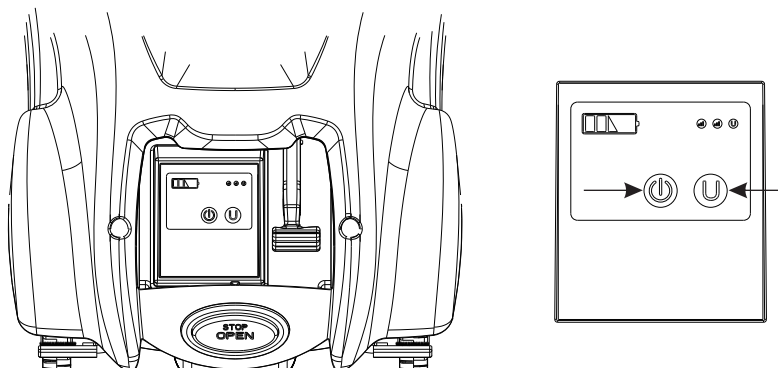

Power Switch: If you press the button, the mower will power on, and if you press once again, the mower will power off.

Sonic Switch: If you press the button one time, sonic function will be open, and **U** led will light, twice sonic function close, **U** led off.

3.4 Movement pattern

The mower's movement pattern is paralleled determined by mower itself. When the mower senses that it has reached all boundaries of the lawn, the mower will enter into random pattern.

This mowing system enables the lawn to be mown equally without any mowing lines. If mower enters an area where it senses the grass is longer than earlier, it can change the moving speed low. If the grass is in normal height the mower accelerate back to regular speed.

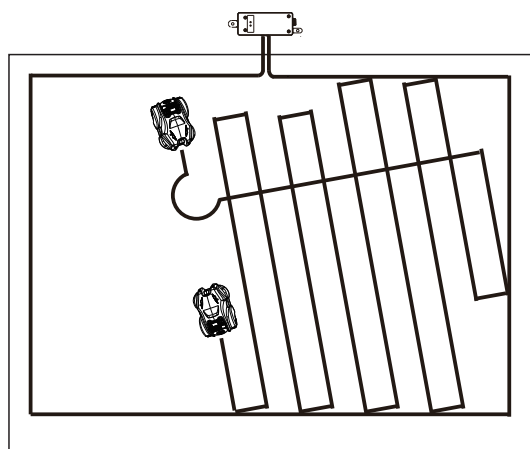

4. Installation

Please read the whole chapter before installation. Only proper installation will enable the mower to operate as intended. It is therefore important to plan the installation care-fully.

Before installation, Please draw a sketch of the operating area, including all obstacles. This makes it easier to see the ideal positions for the signal generator, boundary wire and guide wire.

Carry out the installation in the following steps:

- 4.1 Preparations.
- 4.2. Installation of the signal generator.
- 4.3 Charging the battery.
- 4.4 Installation of the boundary wire
- 4.5 Obstacle instruction.
- 4.6 Connecting the boundary wire with signal generator.
- 4.7 Checking the installation.
- 4.8 Linking Mower to the signal generator.

4.1 Preparations

1. If the grass in the proposed working area is taller than 10cm, Please mow it first using a normal lawn mower. Then collect the clippings.
2. Check that all components are included:
 - a. Operator's Manual
 - b. Mower
 - c. Signal Generator
 - d. Boundary wire
 - e. Nails
 - f. Adapter
 - g. Staples
 - h. Add ->hammer for Staples and a straight spade, plier for bury wire.

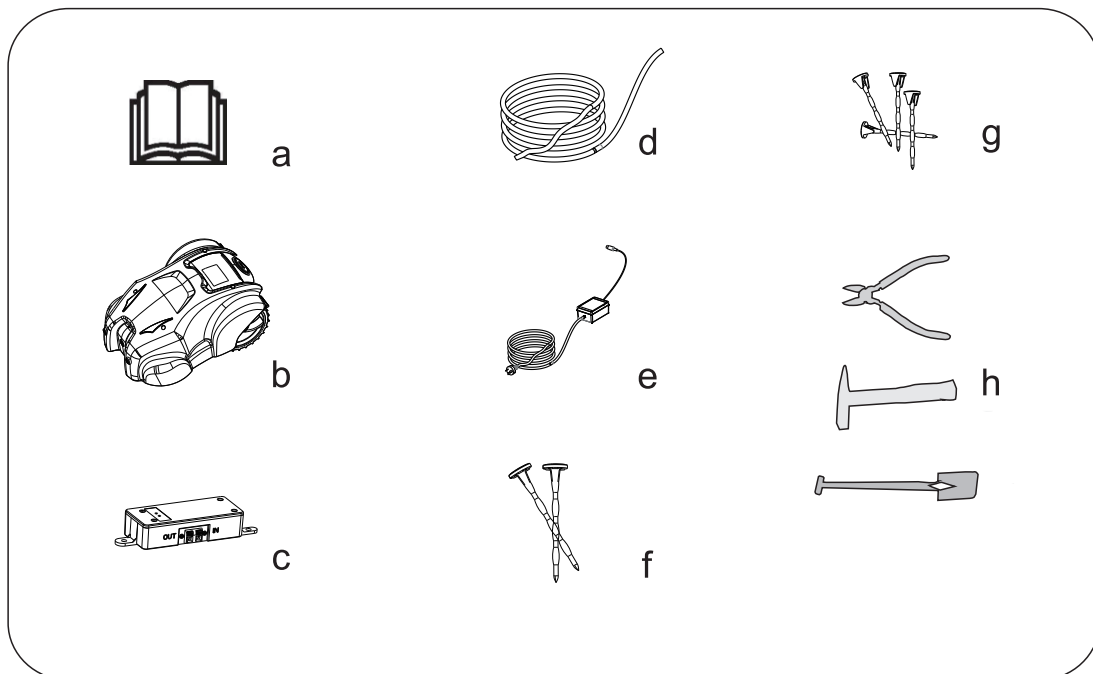

4.2 Installation of the signal generator

1. Select position of the signal generator
 - a. The signal generator must be positioned with wide open area 1.5 meters (5ft) in front of it.

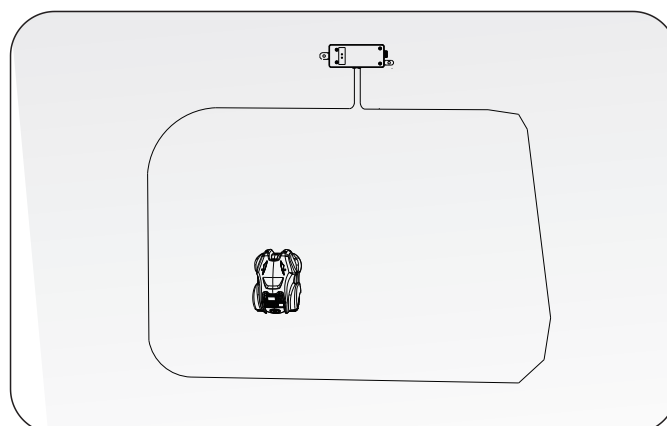

- b. The signal generator must be positioned on the same horizontal level.
The height difference must not differ more than 3cm.
- c. It is possible to let the low voltage cable being laid across the working area.
It must be either stapled down or buried. In some cases, a better option is to position the signal generator close to a house wall.

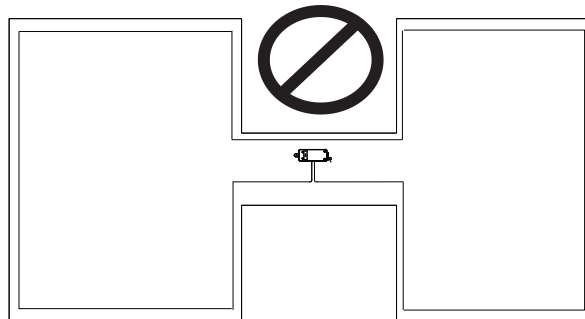

- d. Avoid placing the signal generator near hydrant.

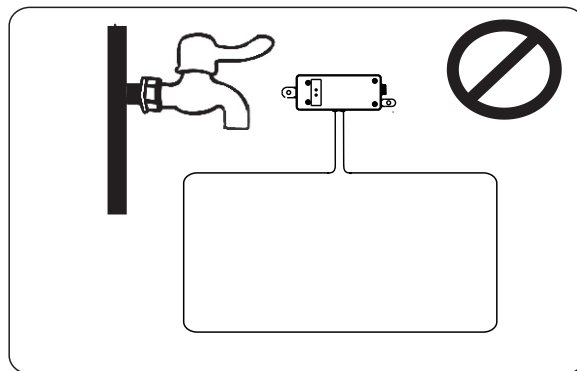

- e. Avoid exposing the adaptor to direct sunlight.
- f. Make sure the opening of the signal generator points towards the direction of counterclockwise.

2. Installing and connecting the signal generator

- a. place the signal generator in an suitable spot;
- b. secure the signal generator to the ground using the supplied nails (1,2)

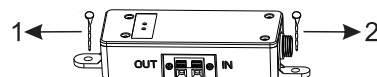

- c. Connect the low voltage cable to the signal generator.
- d. Connect the adaptor power cord to a 120V (230V) wall socket.

4.3 Charging the battery

Mower is supplied with an uncharged battery. You can insert the plug of the power adapter in back of the mower

4.4 Installation of the boundary wire

1. If you want to make adjustments to the boundary wire in the future, it is preferable to staple the boundary wire on the ground. You may water the desired position to make it easier to insert the staples.
2. If you will not adjust the boundary in the near future, it is preferable to bury the wire. You may utilize both methods to achieve a better performance based on scenario.
3. The boundary wire should be laid in a loop around mower's working area.

It is preferable to begin bury wire from one end of the signal generator, and work your way back to the end of the signal generator.

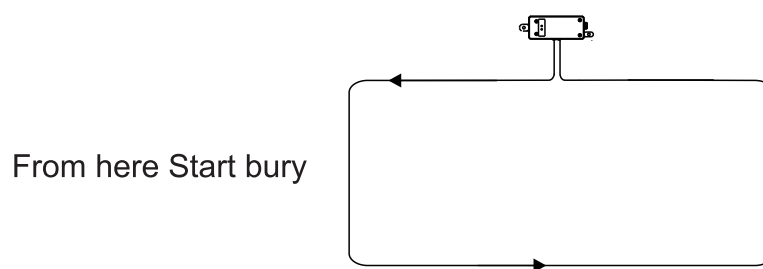

4. The boundary wire should be laid 40cm away from the area edge, obstacles, fence and flower bed, etc. This will prevent mower from colliding with the obstacle and reduce body wear.
5. In all corners, don't lay the boundary wire by acute angle and right angle; it is preferable to lay it by an arc that has at least a 50cm radius.
6. When there are several working areas, the width of the passage should be wider than 1.2m (4ft); otherwise it is difficult for the mower to move between areas.

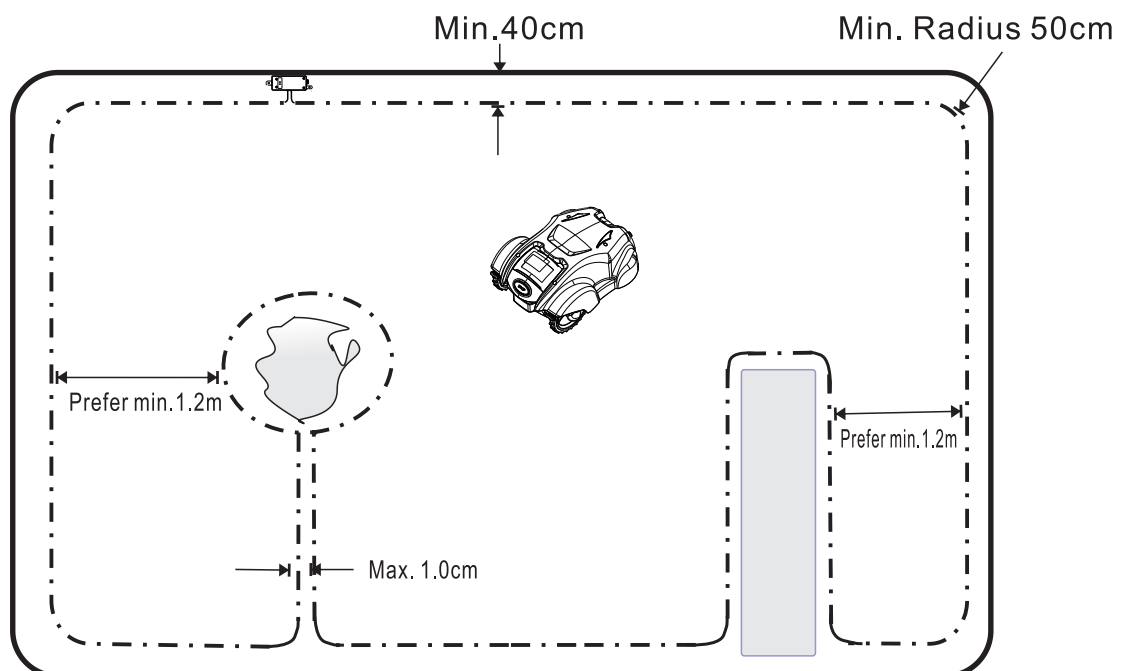

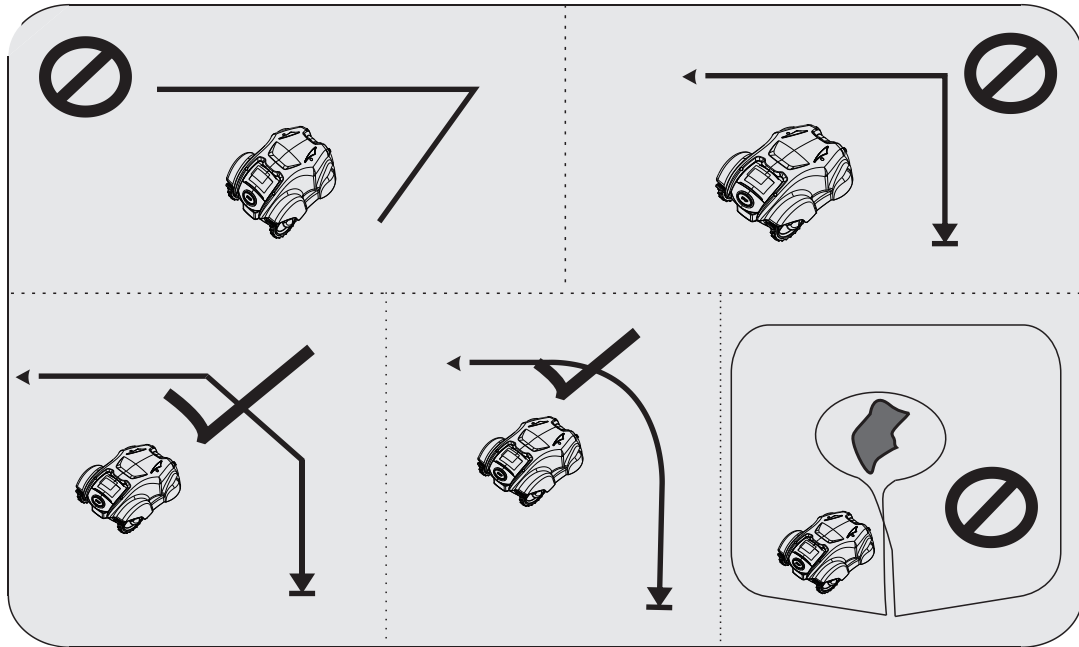

4.5 Obstacle instruction

1. Tree, pole, brick, or heavy obstacle with hard and sturdy materials may serve as natural borders; boundary wire is optional around these obstacles.
2. Plants and objects with refined and fragile surface materials need to be bound by wire for protection.
3. However, complex terrain such as tree root may also require boundary wire to protect and avoid the blades of the mower being worn.

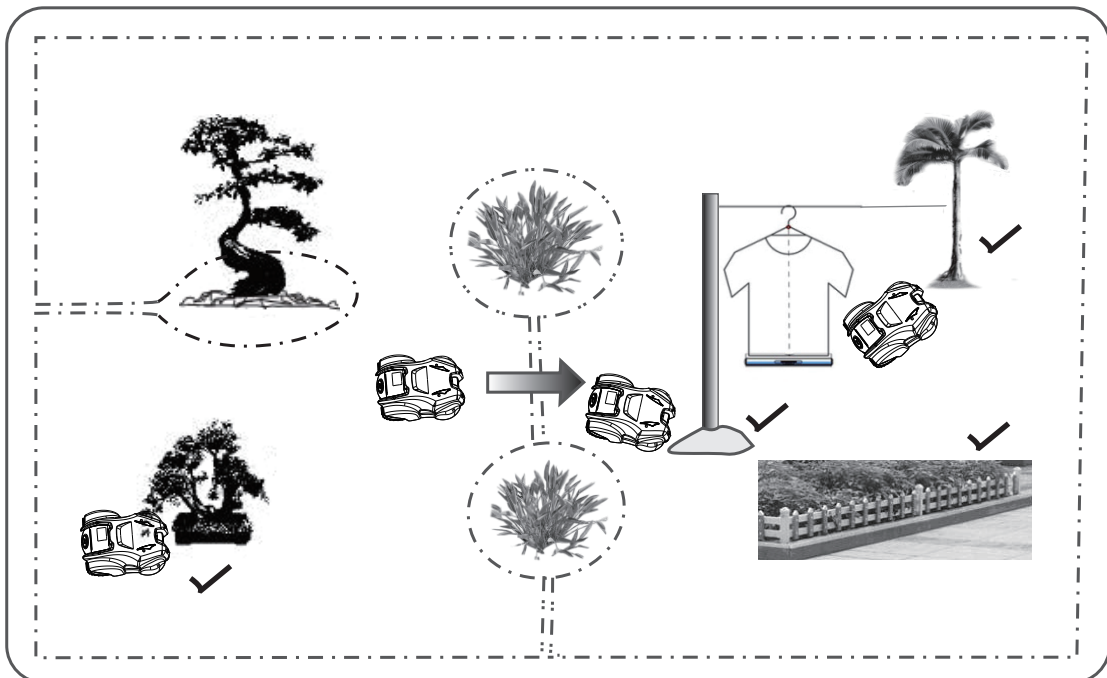

4. Make sure to lay the boundary wire tight to the ground. If the boundary wire is loosed or rolled on the lawn, the mower may cut off the wire and the signal maybe not good enough for mower to receive.

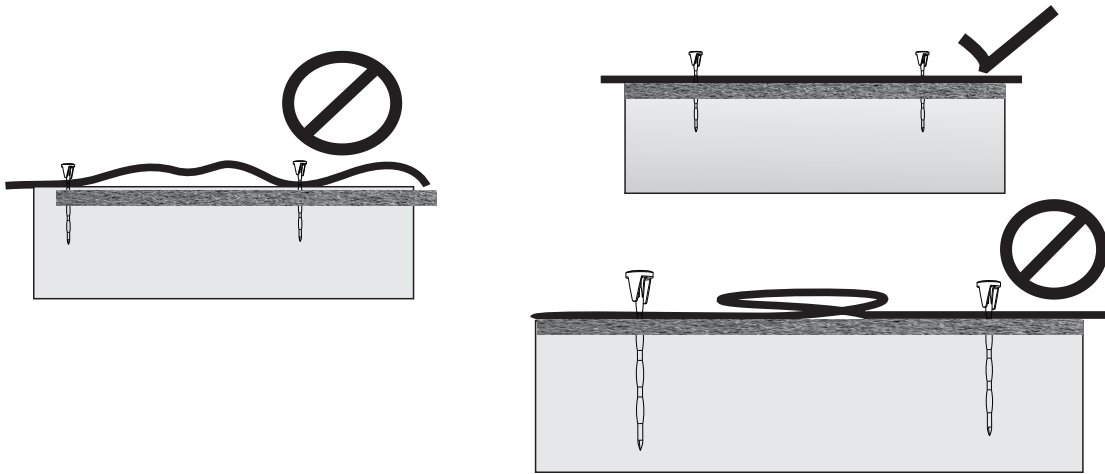

5. Use a hammer to hammer down the staples into the ground. Exercise with care When knocking the staples and make sure the wire is flat on the lawn, the distance of each staple should be approximately 100cm (3ft). But around the corner, staples distance is 30~ 50cm (1~2ft) maybe.
6. Wire should stay straight and untangled, do not roll to shorten the length or for any purpose.

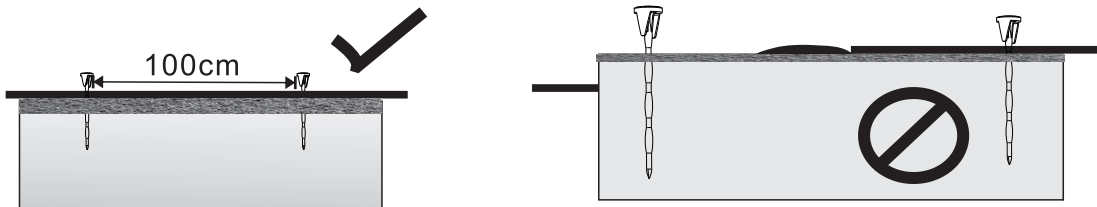

7. If you intend to bury the boundary wire, make sure to place the boundary wire between 1cm to 15cm (0.4 to 6inches) into the ground, and the boundary wire should stay straight and untangled.

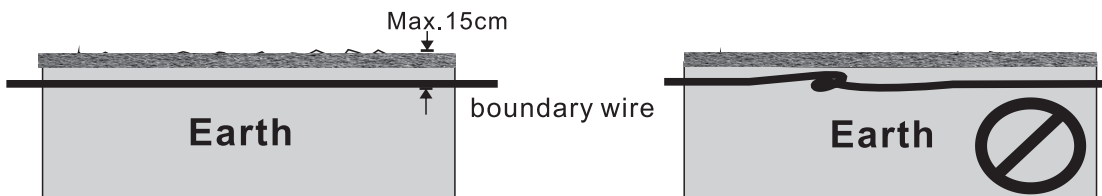

4.6 Connecting the boundary wire with **Signal generator**

1. There are 2 guide wires being installed in signal generator. See Illustration 1 and 2.
2. Use a plier to peel off the robber skin of the wire, and strand the copper wire, see Illustration "a".
3. Use the electrical tape pack; bind the wire like Illustration "b".
4. Connecting 2 ends of boundary wire with 2 guide wires complete the close loop of boundary area.

Please follow below method to connecting.

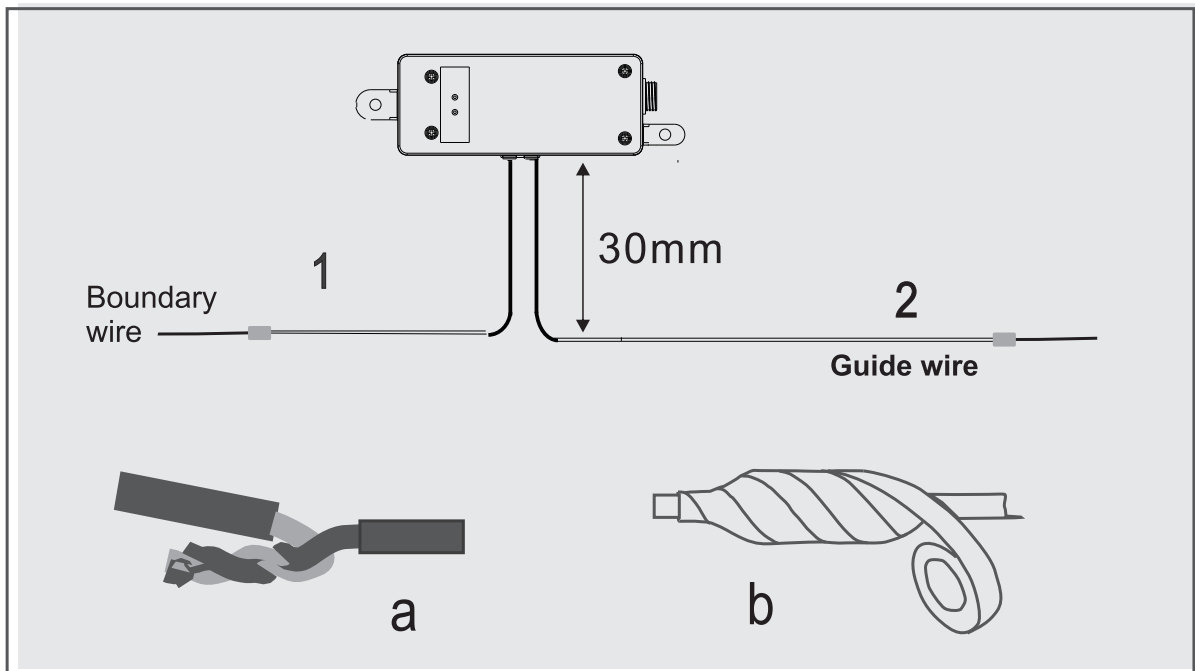

4.7 Checking the installation

Check the green LED signal light on the signal generator to ensure the boundary wire is properly installed.

- Flashing once every other second: The signal is good.
- Not light: Means fail to connect the loop and no signal is found.

5. Use

5.1 Charging a discharged battery

When mower is new or has been stored for a long period, the battery needs to be charged before starting. Charging takes 4 hours.

If the connection is proper, information about the charging process is shown on the display during the entire charging process.

5.2 Using the timer

To obtain optimal the quality of your lawn, the lawn should not be cut too often. For example, the mowing time must match lawn area, mown every other day is better than 12 hours each day, benefited grass rest completely during at least a three-day period once a month.

5.3 Starting mower

1. Press the **STOP/OPEN** button to open the control panel cover.
2. Press power **ON-OFF** button of control panel, to power on the Egen Mower.
3. Close the cover.

The message mowing should be showing on the panel, the blade motor turn on firstly then the driver wheels start to run.

5.4 Stopping mower

Press the **STOP/OPEN** button, the mower will stop, and the blade motor stops in one second, and the control panel cover will be opened.

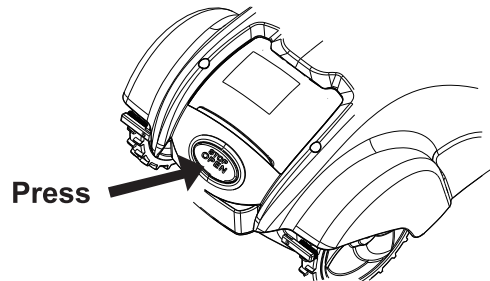

5.5 Restart

When completed the control panel operating, you may close the control panel cover to restart Egen Mower automatically.

If more than 4 minutes has elapsed since the last time the **STOP/OPEN** button was pressed, the Restart function is unable. You must Close the control panel cover.

5.6 Switching off mower

1. Press the **STOP/OPEN** button.
2. Press power switch.

Display should be clear if the machine is properly shut down.

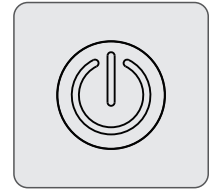
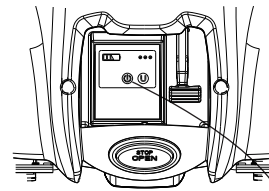

Press this button

5.7 Adjusting the cutting height

The cutting height can be varied from MIN.2cm (0.8") to MAX. 7cm (2.8"). If the grass is tall it is appropriate to let Mower start mowing at the MAX cutting height. Once the grass is shorter, you can gradually lower the cutting height. To adjust the cutting height:

Step1: Press the **STOP/OPEN** button to stop the mower, and then open the cover of control panel.

Step2: Lift up the handle then pulls or push to the desired position.

The selected position is marked on the right of the handle.

Step3: Pull and keep T-bar in Horizontal direction to raise the cutting height.

Step4: Push and keep T-bar in Horizontal direction to lower the cutting height.

Step5: Lower down the handle, and ensure that it is locked.

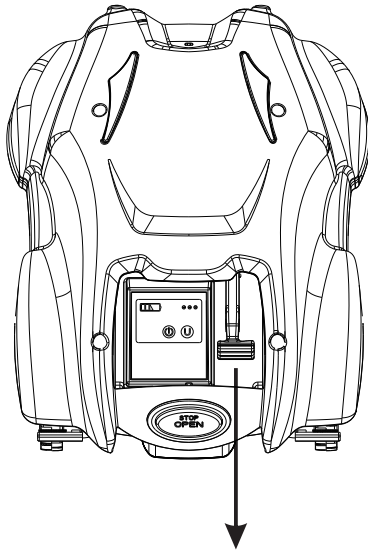

T-bar handle

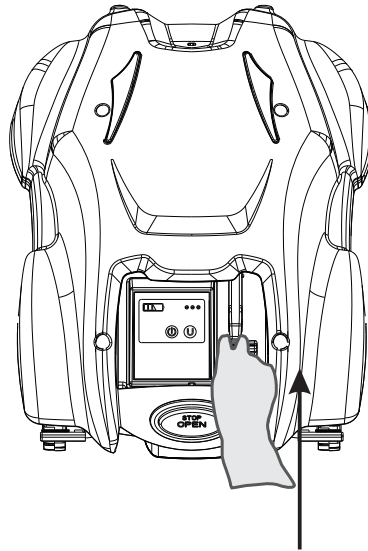

Pull/Push the T-bar to target position then lower down the handle.

6. Control panel

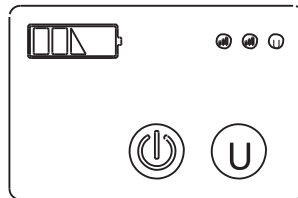

Power **ON/OFF**



: Power **ON/OFF** button

If you press the button, the mower will power on, and if you press once again, the mower will power off.



: Sonic button

If you press the button one time, sonic function will be open, and **U** led will light, twice sonic function close, **U** led off.

7. Maintenance

1. Check and clean mower regularly once a week.
2. During the initial period of use, the blade plate protection plate and blades should be checked once a month.
3. It is important that the blade plate rotates smoothly. In addition, if the blade plate is held, the protection plate should rotate easily too.
4. The edges of the blades should not be damaged. The service lifespan of the blade depends on the type of grass and soil lawn.
5. Operating with dull blades results in poor performance. The height of the lawn will be inconsistent with some left overs. The mower will demand more energy to finish same area of lawn.
6. Fully charge the battery at the end of the season before winter storage. If the time of storage is longer than one year, please recharge the mower again.

8. Cleaning

1. Never use a high-pressure washer or even running water to clean mower.



2. It is important to keep mower clean. A mower with a large amount of clippings negotiates blades slopes very poorly, and needs more power to driver the blade plate.
3. We recommend a brush and spray with water to clean the bottom body, and a damp, soft sponge or cloth to clean the top body and outer case.

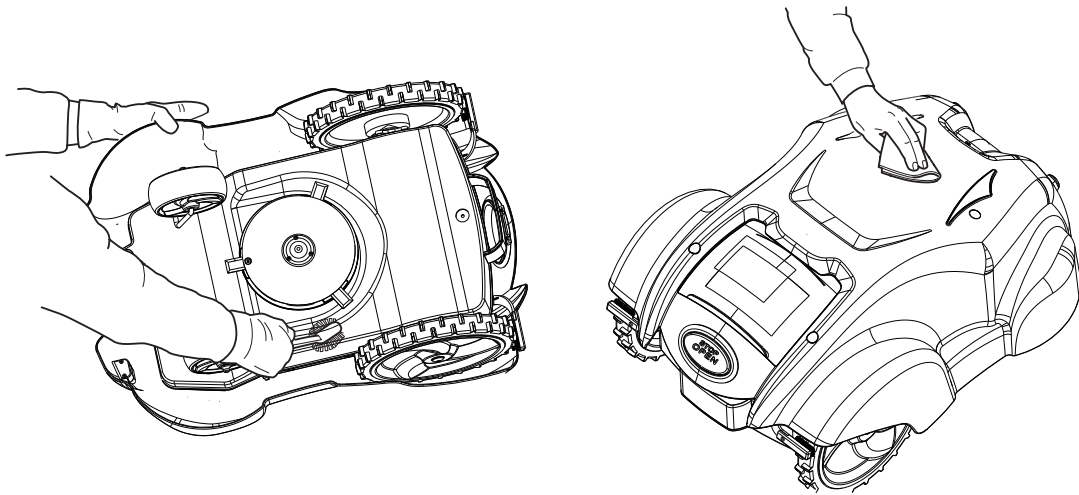

9. Change the blades

To replace the blades:

Step1. Power off the mower.

Step2. Wear protective gloves.

Step3. Turn mower upside down.

Step4. Rotate the skid plate so that its hole aligns with the screw for the blade.

Step5. Unscrew the blade. Use a straight slot or cross-tip screwdriver.

Step6. Pry apart the protect plate and blade plate a little and remove the blade and screw.

Step7. Screw tight the new blade.

Step8. Because blades turn only one direction, so only one side of the blade is worn each time, thus we can flip to another side to prolong the usage of the blade.

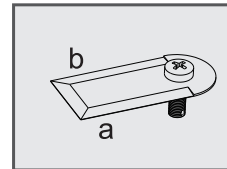
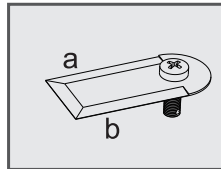
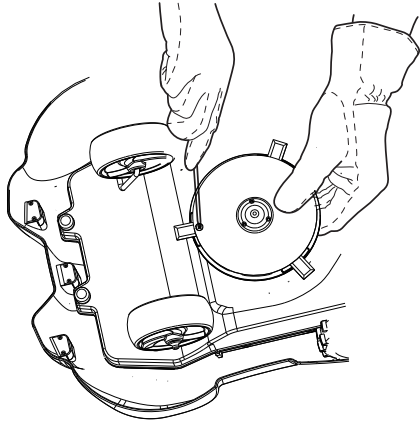

10. Winter storage

1. Mower must be carefully cleaned before winter storage. Fully charge the battery before winter storage.
2. Store the mower in the station, and place it in an area that is dry and free from frost, preferably in the original packaging,
3. The boundary wire can be remained on/in the ground. Because the charging station is taken away, you should protect the ends of the boundary wire from moisture by wrapping it with electrical tape.

11. After winter storage

1. Check whether mower, contact strips and charging strips need to be cleaned before using. If the charging or contact strips appear to be rusted, clean them using grade emery cloth.
2. Check whether the blades need to be change.
3. Check if the blade plate and protect plate turn smoothly. If not, please connect the service to resolve.

12. Disposal



Disposal of an exhausted battery pack

To preserve natural resources, please recycle or dispose of the battery pack properly. Consult your local waste authority for information regarding available recycling and/or disposal options. Discharge your battery pack by operating your tool, then remove the battery pack from the tool and cover the battery pack connections with heavy duty adhesive tape to prevent short circuit and energy discharge. Do not attempt to open or remove any of the components.



Electrical products should not be discarded with household products. According to the European Directive 2012/19/EU on waste electrical and electronic equipment and its implementation into national law, electrical products used must be collected separately and disposed of at collection points provided for this purpose. Talk with your local authorities or dealer for advice on recycling.

13. Technical data

Tension	29.4V $\overline{=}$ 1.5A
Batteries	21.6V, 2600mAh, 56.16Wh, Li-ion battery
Weight	7.5 kg
Sound pressure level	<70 dB(A)
Guarantee sound power level	80 dB(A)
Size	600x420x290 mm
Tension	100-240V~50/60Hz
Operation area	500 m ²
Setting of cutting height	2-7 cm
Mowing speed	190 mm
Slope	Max 30 degrees
Time of battery charge	2 h
Average working time per load	100 min
Speed	3500/min
Power	30W
Average operation speed	22 m/min
Class of protection	III
Degree of protection	IPX44

CE DECLARATION PAGE

BUILDER SAS
ZI, 32 rue Aristide Berges – 31270 Cugnaux - France
Declares that the machine indicated below:
MOWER ROBOT

Serial number : **20190117226-20190117325**
Complies with the provisions of the Directive "machinery" 2006/42 /
EC and national laws transposing it;

Also complies with the following European directives:
EMC Directive 2014/30/EU
ROHS Directive 2011/65/EU
R&TTE 1999/5/EC
Directive on noise emission 2000/14 / EC + Annex VI and
2005/88/EC

Is also in line with European standards, with national standards
and the following technical provisions:

EN 60335-1:2012+A11:2014
EN 50636-2-107:2015
EN 55014-1:2006+A1:2009+A2:2011
EN 55014-2:1997+A1:2001+A1:2008
EN 61000-3-2:2014
EN 61000-3-3:2013
EN 62233:2008

Cugnaux, the 02/01/2019



Philippe MARIE / CEO

Responsible of technical file: M. Olivier Patriarca

HYUNDAI

POWER PRODUCTS

For Inquiries, please contact:

BUILDER SAS

32, rue Aristide Bergès Z1 31270 Cugnaux, France

Tél. : +33 (0) 5.34.502.502 Fax : +33 (0) 5.34.502.503

<http://www.hyundai-power-fr.com/>

Fabriqué en République Populaire de Chine (PRC)