

HYUNDAI
POWER PRODUCTS

CORDLESS TOOLS PACK 18V

HNHPACK18V

ORIGINAL INSTRUCTIONS

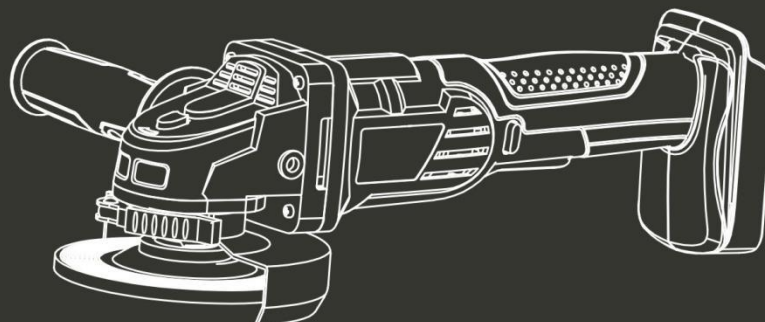
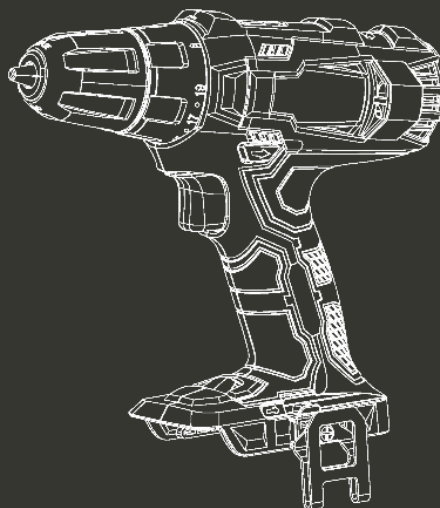
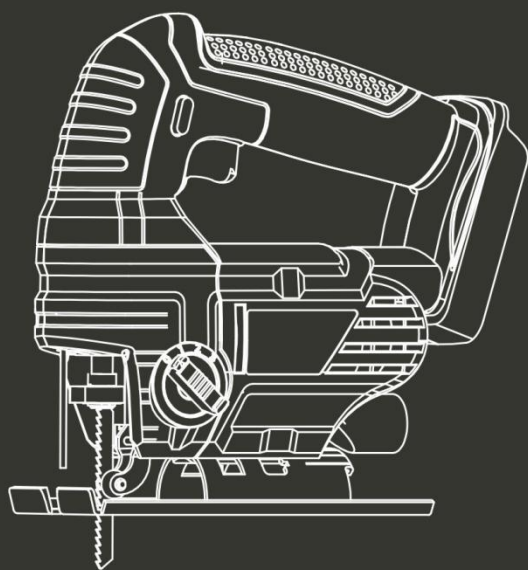

CAUTION: READ THIS INSTRUCTION MANUAL BEFORE USE THIS TOOL !

CONTENTS

1. 18V CORDLESS JIGSAW.....	3
2. 18V CORDLESS DRILL.....	14
3. 18V CORDLESS ANGLE GRINDER.....	26
4. WARRANTY.....	42
5. PRODUCT FAILURE.....	43
6. WARRANTY EXCLUSIONS.....	44

1. 18V CORDLESS JIGSAW

1. APPLICATION

The power tool is intended for sawing wood, metal and plastics. Not suitable for professional use.

2. SAFETY INSTRUCTIONS



WARNING Read all safety warnings, instructions, illustrations and specifications provided with this power tool. *Failure to follow all instructions listed below may result in electric shock, fire and/or serious injury.*

Save all warnings and instructions for future reference.

The term "power tool" in the warnings refers to your mains-operated (corded) power tool or battery-operated (cordless) power tool.

1) Work area safety

- a) **Keep work area clean and well lit.** *Cluttered or dark areas invite accidents.*
- b) **Do not operate power tools in explosive atmospheres, such as in the presence of flammable liquids, gases or dust.** *Power tools create sparks which may ignite the dust or fumes.*
- c) **Keep children and bystanders away while operating a power tool.** *Distractions can cause you to lose control.*

2) Electrical safety

- a) **Power tool plugs must match the outlet. Never modify the plug in any way. Do not use any adapter plugs with earthed (grounded) power tools.** *Unmodified plugs and matching outlets will reduce risk of electric shock.*
- b) **Avoid body contact with earthed or grounded surfaces, such as pipes, radiators, ranges and refrigerators.** *There is an increased risk of electric shock if your body is earthed or grounded.*
- c) **Do not expose power tools to rain or wet conditions.** *Water entering a power tool will increase the risk of electric shock.*
- d) **Do not abuse the cord. Never use the cord for carrying, pulling or unplugging the power tool. Keep cord away from heat, oil, sharp edges or moving parts.** *Damaged or entangled cords increase the risk of electric shock.*
- e) **When operating a power tool outdoors, use an extension cord suitable for outdoor use.** *Use of a cord suitable for outdoor use reduces the risk of electric shock.*
- f) **If operating a power tool in a damp location is unavoidable, use a residual current device (RCD) protected supply.** *Use of an RCD reduces the risk of electric shock.*

3) Personal safety

- a) **Stay alert, watch what you are doing and use common sense when operating a power tool. Do not use a power tool while you are tired or under the influence of drugs, alcohol or medication.** *A moment of inattention while operating power tools may result in serious personal injury.*
- b) **Use personal protective equipment. Always wear eye protection.** *Protective equipment such as a dust mask, non-skid safety shoes, hard hat or hearing protection used for appropriate conditions will reduce personal injuries.*
- c) **Prevent unintentional starting. Ensure the switch is in the off-position before connecting to power source and/or battery pack, picking up or carrying the tool.** *Carrying power tools with your finger on the switch or energising power tools that have the switch on invites accidents.*
- d) **Remove any adjusting key or wrench before turning the power tool on.** *A wrench or a key left attached to a rotating part of the power tool may result in personal injury.*

- e) **Do not overreach. Keep proper footing and balance at all times.** *This enables better control of the power tool in unexpected situations.*
- f) **Dress properly. Do not wear loose clothing or jewellery. Keep your hair and clothing away from moving parts.** *Loose clothes, jewellery or long hair can be caught in moving parts.*
- g) **If devices are provided for the connection of dust extraction and collection facilities, ensure these are connected and properly used.** *Use of dust collection can reduce dust-related hazards.*
- h) **Do not let familiarity gained from frequent use of tools allow you to become complacent and ignore tool safety principles.** *A careless action can cause severe injury within a fraction of a second.*

4) Power tool use and care

- a) **Do not force the power tool. Use the correct power tool for your application.** *The correct power tool will do the job better and safer at the rate for which it was designed.*
- b) **Do not use the power tool if the switch does not turn it on and off.** *Any power tool that cannot be controlled with the switch is dangerous and must be repaired.*
- c) **Disconnect the plug from the power source and/or remove the battery pack, if detachable, from the power tool before making any adjustments, changing accessories, or storing power tools.** *Such preventive safety measures reduce the risk of starting the power tool accidentally.*
- d) **Store idle power tools out of the reach of children and do not allow persons unfamiliar with the power tool or these instructions to operate the power tool.**
Power tools are dangerous in the hands of untrained users.
- e) **Maintain power tools and accessories. Check for misalignment or binding of moving parts, breakage of parts and any other condition that may affect the power tool's operation. If damaged, have the power tool repaired before use.** *Many accidents are caused by poorly maintained power tools.*
- f) **Keep cutting tools sharp and clean.** *Properly maintained cutting tools with sharp cutting edges are less likely to bind and are easier to control.*
- g) **Use the power tool, accessories and tool bits etc. in accordance with these instructions, taking into account the working conditions and the work to be performed.** *Use of the power tool for operations different from those intended could result in a hazardous situation.*
- h) **Keep handles and grasping surfaces dry, clean and free from oil and grease.** *Slippery handles and grasping surfaces do not allow for safe handling and control of the tool in unexpected situations.*

5) Battery tool use and care

- a) **Recharge only with the charger specified by the manufacturer.** *A charger that is suitable for one type of battery pack may create a risk of fire when used with another battery pack.*
- b) **Use power tools only with specifically designated battery packs.** *Use of any other battery packs may create a risk of injury and fire.*
- c) **When battery pack is not in use, keep it away from other metal objects, like paper clips, coins, keys, nails, screws or other small metal objects, that can make a connection from one terminal to another.** *Shorting the battery terminals together may cause burns or a fire.*
- d) **Under abusive conditions, liquid may be ejected from the battery; avoid contact. If contact accidentally occurs, flush with water. If liquid contacts eyes, additionally seek medical help.** *Liquid ejected from the battery may cause irritation or burns.*
- e) **Do not use a battery pack or tool that is damaged or modified.** *Damaged or modified batteries may exhibit unpredictable behaviour resulting in fire, explosion or risk of injury.*
- f) **Do not expose a battery pack or tool to fire or excessive temperature.** *Exposure to fire or temperature above 130 °C may cause explosion.*

NOTE The temperature „130 °C“ can be replaced by the temperature „265 °F“.

g) **Follow all charging instructions and do not charge the battery pack or tool outside the temperature range specified in the instructions.** *Charging improperly or at temperatures outside the specified range may damage the battery and increase the risk of fire.*

6) Service

a) **Have your power tool serviced by a qualified repair person using only identical replacement parts.** *This will ensure that the safety of the power tool is maintained.*

b) **Never service damaged battery packs.** *Service of battery packs should only be performed by the manufacturer or authorized service providers.*

Hold power tool by insulated gripping surfaces, when performing an operation where the cutting accessory may contact hidden wiring. *Cutting accessory contacting a "live" wire may make exposed metal parts of the power tool "live" and could give the operator an electric shock.*

SPECIAL SAFETY INSTRUCTIONS FOR JIG SAWS



Important! Use of any accessories or attachments other than those supplied or recommended in these operating instructions can mean the risk of injury.

- When using jig saws ear protectors and a face mask should be worn. Exposure to noise can cause damage to hearing.
- Do not use the jig saw to cut asbestos or materials containing asbestos.
- Do not leave power tools running unattended. Always switch off and do not put down or leave until it has stopped completely.
- Long hair must be covered. Do not work in loose fitting clothing.
- Be careful when working on walls. Damage to power supply lines, gas or water pipes can lead to dangerous situations. Use appropriate detectors to establish whether there are concealed wires or pipes in the working area.
- Secure the work piece. The work piece is only secure if it is held by work-holding devices or in a vice.
- Caution: saw blades can get very hot.
- Saw blades must be kept sharp and in good condition. Replace partially fractured and broken saw blades immediately.
- Work calmly and evenly with the jig saw. You will thus avoid accidents and the saw blades and the jig saw will last longer.
- Do not use for cutting pipes or cables.
- Do not use cracked, blunt or damaged blades.
- Do not start the saw if no blade is fitted.
- Check there are no obstructions in/on the surface under the item to be cut.
- Do not attempt to cut items thicker than the maximum cutting depth of the blade, or where there is insufficient space for the blade under the item.
- The saw's metal parts may become conductive if the saw comes into contact with a live wire. Therefore only hold the saw by its insulated handle.
- Check that the ventilation slots are not blocked.
- Never remove dust, obstructions or the like from the work area while the blade is operating.
- Never stop the saw blade by applying pressure to the saw or to the side of the blade.
- Do not lift the saw from the item being cut if the blade is still running.
- Never place the saw on a table or workbench if it has not stopped completely.
- The saw blade will continue to run a short time after the machine has been switched off.
- Hold power tool by insulated gripping surfaces, when performing an operation where the

cutting accessory may contact hidden wiring or its own cord. Cutting accessory contacting a "live" wire may make exposed metal parts of the power tool "live" and could give the operator an electric shock.

SAFETY INSTRUCTIONS FOR BATTERIES AND CHARGER

Batteries

- Never attempt to open for any reason.
- Do not store in locations where the temperature may exceed 40°C (104°F).
- Charge only at ambient temperatures between 4°C and 40°C (39.2°F and 104°F).
- Charge only using the charger provided with the tool.
- Store your batteries in a cool dry place (5°C-20°C/41°F-68°F). Never store batteries in discharged state.
- It is better for Li-ion batteries to discharge and reload them regularly (at least 4 times a year). The ideal charge for long-term storage of your Li-ion battery is 40% of capacity.
- When disposing of batteries, follow the instructions given in the section "Protecting the environment".
- Do not cause short circuits. If connection is made between the positive (+) and negative (-) terminal directly or via accidental contact with metallic objects, the battery is short circuited and an intense current will flow causing heat generation which may lead to casing rupture or fire.
- Do not heat. If batteries are heated to above 100°C (212°F), sealing and insulating separators and other polymer components may be damaged resulting in electrolyte leakage and/or internal short circuiting leading to heat generation causing rupture or fire. Moreover do not dispose of the batteries in fire, explosion and/or intense burning may result.
- Under extreme conditions, battery leakage may occur. When you notice liquid on the battery, proceed as follows:
 - ✓ Carefully wipe the liquid off using a cloth. Avoid skin contact.
 - ✓ In case of skin or eye contact, follow the instructions below:
 - Immediately rinse with water. Neutralize with a mild acid such as lemon juice or vinegar.
 - In case of eye contact, rinse abundantly with clean water for at least 10 minutes. Consult a physician.



Fire hazard! Avoid short-circuiting the contacts of a detached battery. Do not incinerate the battery.













Charger

- Use the charger provided with the tool only to charge the battery.
- Never attempt to charge non-rechargeable batteries.

- . Have defective cords replaced immediately.
- . Do not expose to water.
- . Do not open the charger.
- . Do not probe the charger.
- . The charger is intended for indoor use only.
- . This charger can be used by children aged from 8 years and above and persons with reduced physical, sensory or mental capabilities or lack of experience and knowledge if they have been given supervision or instruction concerning use of the appliance in a safe way and understand the hazards involved.
- . Children shall not play with the appliance. Cleaning and user maintenance shall not be made by children without supervision.
- . If the supply cord is damaged, it must be replaced by the manufacturer, its service agent or similarly qualified persons in order to avoid a hazard.

CAUTION: Do not recharge non-rechargeable batteries.

Symbols

	Conforms to relevant safety standards
 	To reduce the risk of injury, the user must read and understand this manual before using this product.
	Wear ear protectors. Exposure to noise can cause hearing loss.
	Wear eye protection.
	Class II, double isolation(only for charger)
	Do not dispose of old appliances with domestic rubbish
	Do not expose the charger or the battery to water.
	Do not incinerate the battery or charger.
	Ambient temperature of 40 ° C max. (only for the battery)
	Use the battery and charger Indoor use only.
	Recycling

3. YOUR PRODUCT

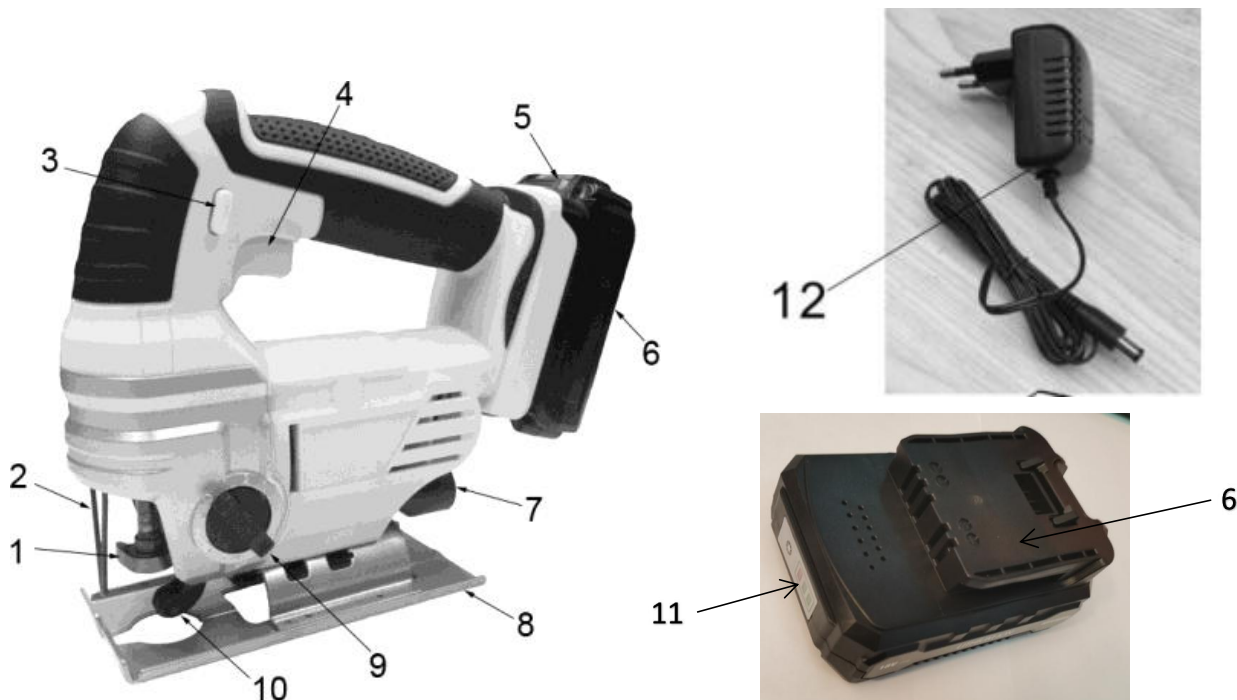

1. Quick-change blade clamping holder
2. Safety guard
3. Lock-off button
4. ON/OFF switch
5. Release button for battery pack
6. Battery pack
7. Dust extraction outlet
8. Soleplate
9. Pendulum regulation control
10. Guide roller
- 11, Battery capacity indication
12. Charger

4. PACKAGE CONTENT LIST

- Remove all packaging materials.
- Remove remaining packing and package inserts (if included).
- Check that the package contents are complete.
- Check the appliance, the power cord, the power plug and all accessories for transportation damage.
- Keep the packing materials as far as possible till the end of the warranty period. Dispose it into your local waste disposal system afterwards.



WARNING: Packaging materials are not toys! Children must not play with plastic bags!

Danger of suffocation!

1x machine

1x manual

1x saw blade for wood

If any parts are missing or damaged, please contact your dealer.

5. OPERATION

Charging the battery pack

IMPORTANT: The battery pack is not fully charged at the factory. Before attempting to charge them, thoroughly read all of the safety instructions.

- 1) To assure that the charger you use are applicable to the battery pack.
- 2) Insert the charger into 100-240V~,50-60Hz outlet. The indicator light (3) become to green light to show the power is connected.
- 3) Insert the end of charger(1) into the slot of battery(2). Make sure the contact with the charger is correct.
- 4) When charging The indicator light (3) become to red light.
- 5) When fully charged The indicator light (3) become to green light.



- 6).Frequently monitor the charger and battery pack while connected.
- 7).Unplug the charger and disconnect it from the battery pack when finished.
- 8).Allow the battery pack to cool completely before using it.
- 9).Store the charger and battery pack indoors, out of reach of children.



Note: If the battery does not fit properly, disconnect it and confirm that the battery pack is the correct model for this charger as shown on the specification chart. Do not charge any other battery pack or any battery pack that does not securely fit the charger.



NOTE: If battery is hot after continuous use in the tool, allow it to cool down to room temperature before charging. This will extend the life of your batteries.



Remove battery pack from charger stand which use your thumb or fingers, press the battery's release button in and pull the battery pack off at the same time.

Battery capacity indicator

There are battery capacity indicators on the battery pack; you can check the capacity status of the battery if you squeeze the button . Before using the machine, please press switch trigger to check if the battery is full enough for properly working.Those 3 LED might show the status of the capacity level of the battery.

Inserting and removing the battery.

1. Remove the battery: press the battery release latch in and at the same time pull the battery pack off.
2. To insert the battery, push the battery pack onto the contacts of the tool.

5.1 Adjusting the soleplate

- The soleplate (8) can be tilt adjusted 45° (left or right) in relation to the saw perpendicular to facilitate contour sawing.
- Loosen the two clamping screws (B) under the soleplate using the hexagon key (A) supplied with the tool, adjust the soleplate to the desired angle and re-tighten the screws (B).
- The angle can be set using a marked scale on top of the soleplate.
- This jig saw is equipped with four cutting actions, one straight and three orbital.
- Orbital action has a more aggressive blade motion and is designed for cutting in soft materials like wood or plastic.



- Orbital action provides faster cut, but with a rougher cut across the material. In orbital action, the blade moves forward during the cutting stroke in addition to the up and down motion.

Note: Metal or hardwoods should never be cut in orbital action.

- To adjust the cutting action, moves the pendulum regulation control (9) between the four cutting positions: 0, 1, 2, and 3.
- Position 0 is the straight cutting.
- Positions 1, 2 and 3 are orbital cutting.
- The aggressiveness of the cut increase as the control is moved from one to three, with three being the most aggressive cut.
- Never use a blade unsuitable for the task and item to be cut.

Hold the saw in front of you with a firm grip on the handle.

- Ensure that the saw blade is not touching anything and that the power cable is not in the way when starting the saw.

Make sure that the item is clamped tight, and that the saw line is clearly marked. Connect the vacuum extractor nozzle to an extractor system where possible.

- Start the saw. Place the soleplate on the item, and let the saw blade touch the saw line.
- Saw, but do not place more pressure on the blade than is necessary. Avoid lateral pressure on the blade.

5.2 Sawing wood

- Check that the item does not contain nails or other metal objects. Always wear a mask.

5.3 Sawing metal

- We recommend lubricating the material and saw blade with cutting oil to protect the tool and avoid overheating. Support the item securely with wooden blocks.



Important! Check all screws on the saw regularly, particularly those that hold the blade. Tighten if required.

6. CLEANING AND MAINTENANCE

6.1 Cleaning

- Keep the ventilation slots of the machine clean to prevent overheating of the engine.
- Regularly clean the machine housing with a soft cloth, preferably after each use.
- Keep the ventilation slots free from dust and dirt.
- If the dirt does not come off use a soft cloth moistened with soapy water.
- Never use solvents such as petrol, alcohol, ammonia water, etc. These solvents may damage the plastic parts.

6.2 Maintenance

- Our machines have been designed to operate over a long period of time with a minimum of maintenance. Continuous satisfactory operation depends upon proper machine care and regular cleaning.

7. TECHNICAL DETAILS

Rated voltage	18V d.c.	Quick change blades	Yes
Rotation speed	0-2400/min	Lock button	Yes
LED worklight	Yes	Base material	Steel
Pendular positions	4	Battery connection	Slide-on
Carbon brush motor	Yes	Acoustic pressure level LpA	86.9 dB(A) K= 5 dB(A)
Adjustable base	Yes	Acoustic power level LwA	97.9 dB(A) K= 5 dB(A)
Stroke height	19 mm	Vibration:	Cutting wood: $a_{h,B}=3.57\text{m/s}^2$, $K=1.5\text{m/s}^2$; Cutting metal: $a_{h,M}=4.14\text{m/s}^2$, $K=1.5\text{m/s}^2$;
Cutting depth steel	6 mm	Battery pack	HNHPACK18V 18V d.c. 1.5Ah Lithium-ion
Cutting depth wood	56 mm	Charger	HNHPACK18V Input 100-240V~ 50-60Hz, 19W Output; 21V d.c. 0.5A
Connection type	T-shank	Charging time	3-5 hours

Information

- The declared vibration total value has been measured in accordance with a standard test method and may be used for comparing one tool with another;
- The declared vibration total value may also be used in a preliminary assessment of exposure.

Warning

- that the vibration emission during actual use of the power tool can differ from the declared total value depending on the ways in which the tool is used; and
- of the need to identify safety measures to protect the operator that are based on an estimation of exposure in the actual conditions of use (taking account of all parts of the operating cycle such as the times when the tool is switched off and when it is running idle in addition to the trigger time).

Wear hearing protection

8. DISPOSAL



Electrical products should not be discarded with household products. According to the European Directive 2012/19/EU on waste electrical and electronic equipment and its implementation into national law, electrical products used must be collected separately and disposed of at collection points provided for this purpose. Talk with your local authorities or dealer for advice on recycling.

BATTERY PACK



This product contains Li-ion. To preserve natural resources, please recycle or dispose of batteries properly. Local, state or federal laws may prohibit disposal of Li-ion batteries in ordinary trash. Consult you local waste authority for information regarding available recycling and/or disposal options.

9. DECLARATION OF CONFORMITY



BUILDER SAS

32 rue Aristide Bergès - Z.I. du Casque - 31270 Cugnaux - France,

declares that,

Product: Cordless Jigsaw 18V

Trade mark: Hyundai

Model: HNHPACK18V

Serial number: 20230448288-20230448437

is in conformity with the essential requirements and other relevant provisions of the applicable European Directives, based on the application of European harmonized standards. Any unauthorized modification of the apparatus voids this declaration.

European Directives (including, if applicable, their amendments up to the date of signature):

Rohs Directive (EU) 2015/863 amending 2011/65 / EU

“Machine” directive 2006/42 / EC

EMC Directive 2014/30 / EC

LVD Directive 2014/35/UE

European harmonized standards (including, if applicable, their amendments up to the date of signature):

EN62841-1: 2015

EN62841-2-11:2016

EN55014-1: 2017+A11:2020

EN55014-2: 2015

EN 62233:2008

EN 60335-2-29:2004+A2:2010+A11:2018

EN 60335-1:2012+A11:2014+A13:2017+A1:2019+A2:2019+A14:2019

EN ICE61000-3-2:2019; EN61000-3-3:2013+A1:2019

Cugnaux, 27/02/2023

Philippe MARIE / PDC

Responsible of the technical file: Mr Olivier Patriarca

2. 18V CORDLESS DRILL

1. APPLICATION

The power tool is intended for driving and drilling through wood, metal, plastics and masonry. Not suitable for professional use.



WARNING! Read this manual and general safety instructions carefully before using the appliance, for your own safety. Your power tool should only be passed on together with these instructions.

2. SAFETY INSTRUCTIONS



WARNING Read all safety warnings, instructions, illustrations and specifications provided with this power tool. Failure to follow all instructions listed below may result in electric shock, fire and/or serious injury.

Save all warnings and instructions for future reference.

The term "power tool" in the warnings refers to your mains-operated (corded) power tool or battery-operated (cordless) power tool.

1) Work area safety

- a) **Keep work area clean and well lit.** Cluttered or dark areas invite accidents.
- b) **Do not operate power tools in explosive atmospheres, such as in the presence of flammable liquids, gases or dust.** Power tools create sparks which may ignite the dust or fumes.
- c) **Keep children and bystanders away while operating a power tool.** Distractions can cause you to lose control.

2) Electrical safety

- a) **Power tool plugs must match the outlet. Never modify the plug in any way. Do not use any adapter plugs with earthed (grounded) power tools.** Unmodified plugs and matching outlets will reduce risk of electric shock.
- b) **Avoid body contact with earthed or grounded surfaces, such as pipes, radiators, ranges and refrigerators.** There is an increased risk of electric shock if your body is earthed or grounded.
- c) **Do not expose power tools to rain or wet conditions.** Water entering a power tool will increase the risk of electric shock.
- d) **Do not abuse the cord. Never use the cord for carrying, pulling or unplugging the power tool. Keep cord away from heat, oil, sharp edges or moving parts.** Damaged or entangled cords increase the risk of electric shock.
- e) **When operating a power tool outdoors, use an extension cord suitable for outdoor use.** Use of a cord suitable for outdoor use reduces the risk of electric shock.
- f) **If operating a power tool in a damp location is unavoidable, use a residual current device (RCD) protected supply.** Use of an RCD reduces the risk of electric shock.

3) Personal safety

- a) **Stay alert, watch what you are doing and use common sense when operating a power tool. Do not use a power tool while you are tired or under the influence of drugs, alcohol or medication.** A moment of inattention while operating power tools may result in serious personal injury.
- b) **Use personal protective equipment. Always wear eye protection.** Protective equipment such as a dust mask, non-skid safety shoes, hard hat or hearing protection used for appropriate conditions will reduce personal injuries.

- c) **Prevent unintentional starting. Ensure the switch is in the off-position before connecting to power source and/or battery pack, picking up or carrying the tool.** *Carrying power tools with your finger on the switch or energising power tools that have the switch on invites accidents.*
- d) **Remove any adjusting key or wrench before turning the power tool on.** *A wrench or a key left attached to a rotating part of the power tool may result in personal injury.*
- e) **Do not overreach. Keep proper footing and balance at all times.** *This enables better control of the power tool in unexpected situations.*
- f) **Dress properly. Do not wear loose clothing or jewellery. Keep your hair and clothing away from moving parts.** *Loose clothes, jewellery or long hair can be caught in moving parts.*
- g) **If devices are provided for the connection of dust extraction and collection facilities, ensure these are connected and properly used.** *Use of dust collection can reduce dust-related hazards.*
- h) **Do not let familiarity gained from frequent use of tools allow you to become complacent and ignore tool safety principles.** *A careless action can cause severe injury within a fraction of a second.*

4) Power tool use and care

- a) **Do not force the power tool. Use the correct power tool for your application.** *The correct power tool will do the job better and safer at the rate for which it was designed.*
- b) **Do not use the power tool if the switch does not turn it on and off.** *Any power tool that cannot be controlled with the switch is dangerous and must be repaired.*
- c) **Disconnect the plug from the power source and/or remove the battery pack, if detachable, from the power tool before making any adjustments, changing accessories, or storing power tools.** *Such preventive safety measures reduce the risk of starting the power tool accidentally.*
- d) **Store idle power tools out of the reach of children and do not allow persons unfamiliar with the power tool or these instructions to operate the power tool.**
Power tools are dangerous in the hands of untrained users.
- e) **Maintain power tools and accessories. Check for misalignment or binding of moving parts, breakage of parts and any other condition that may affect the power tool's operation. If damaged, have the power tool repaired before use.** *Many accidents are caused by poorly maintained power tools.*
- f) **Keep cutting tools sharp and clean.** *Properly maintained cutting tools with sharp cutting edges are less likely to bind and are easier to control.*
- g) **Use the power tool, accessories and tool bits etc. in accordance with these instructions, taking into account the working conditions and the work to be performed.** *Use of the power tool for operations different from those intended could result in a hazardous situation.*
- h) **Keep handles and grasping surfaces dry, clean and free from oil and grease.** *Slippery handles and grasping surfaces do not allow for safe handling and control of the tool in unexpected situations.*

5) Battery tool use and care

- a) **Recharge only with the charger specified by the manufacturer.** *A charger that is suitable for one type of battery pack may create a risk of fire when used with another battery pack.*
- b) **Use power tools only with specifically designated battery packs.** *Use of any other battery packs may create a risk of injury and fire.*
- c) **When battery pack is not in use, keep it away from other metal objects, like paper clips, coins, keys, nails, screws or other small metal objects, that can make a connection from one terminal to another.** *Shorting the battery terminals together may cause burns or a fire.*
- d) **Under abusive conditions, liquid may be ejected from the battery; avoid contact. If contact accidentally occurs, flush with water. If liquid contacts eyes, additionally seek medical help.** *Liquid ejected from the battery may cause irritation or burns.*
- e) **Do not use a battery pack or tool that is damaged or modified.** *Damaged or modified batteries may exhibit unpredictable behaviour resulting in fire, explosion or risk of injury.*

f) **Do not expose a battery pack or tool to fire or excessive temperature.** *Exposure to fire or temperature above 130 °C may cause explosion.*

NOTE The temperature „130 °C“ can be replaced by the temperature „265 °F“.

g) **Follow all charging instructions and do not charge the battery pack or tool outside the temperature range specified in the instructions.** *Charging improperly or at temperatures outside the specified range may damage the battery and increase the risk of fire.*

6) Service

a) **Have your power tool serviced by a qualified repair person using only identical replacement parts.** *This will ensure that the safety of the power tool is maintained.*

b) **Never service damaged battery packs.** *Service of battery packs should only be performed by the manufacturer or authorized service providers.*

Drill safety warnings

– **Wear ear protectors when impact drilling.** *Exposure to noise can cause hearing loss.*

– **Use auxiliary handle(s), if supplied with the tool.** *Loss of control can cause personal injury.*

Hold power tool by insulated gripping surfaces, when performing an operation where the cutting accessory may contact hidden wiring. *Cutting accessory contacting a "live" wire may make exposed metal parts of the power tool "live" and could give the operator an electric shock.*

Safety instructions when using long drill bits

a) **Never operate at higher speed than the maximum speed rating of the drill bit.** *At higher speeds, the bit is likely to bend if allowed to rotate freely without contacting the workpiece, resulting in personal injury.*

b) **Always start drilling at low speed and with the bit tip in contact with the workpiece.** *At higher speeds, the bit is likely to bend if allowed to rotate freely without contacting the workpiece, resulting in personal injury.*

c) **Apply pressure only in direct line with the bit and do not apply excessive pressure.** *Bits can bend causing breakage or loss of control, resulting in personal injury.*

SAFETY INSTRUCTIONS FOR BATTERIES AND CHARGER

Batteries

- Never attempt to open for any reason.
- Do not store in locations where the temperature may exceed 40°C (104°F).
- Charge only at ambient temperatures between 4°C and 40°C (39.2°F and 104°F).
- Charge only using the charger provided with the tool.
- Store your batteries in a cool dry place (5°C-20°C/41°F-68°F). Never store batteries in discharged state.
- It is better for Li-ion batteries to discharge and reload them regularly (at least 4 times a year). The ideal charge for long-term storage of your Li-ion battery is 40% of capacity.
- When disposing of batteries, follow the instructions given in the section "Protecting the environment".
- Do not cause short circuits. If connection is made between the positive (+) and negative (-) terminal directly or via accidental contact with metallic objects, the battery is short circuited and an intense current will flow causing heat generation which may lead to casing rupture or fire.

- Do not heat. If batteries are heated to above 100°C (212°F), sealing and insulating separators and other polymer components may be damaged resulting in electrolyte leakage and/or internal short circuiting leading to heat generation causing rupture or fire. Moreover do not dispose of the batteries in fire, explosion and/or intense burning may result.
- Under extreme conditions, battery leakage may occur. When you notice liquid on the battery, proceed as follows:
 - ✓ Carefully wipe the liquid off using a cloth. Avoid skin contact.
 - ✓ In case of skin or eye contact, follow the instructions below:
 - Immediately rinse with water. Neutralize with a mild acid such as lemon juice or vinegar.
 - In case of eye contact, rinse abundantly with clean water for at least 10 minutes. Consult a physician.



Fire hazard! Avoid short-circuiting the contacts of a detached battery. Do not incinerate the battery.











Charger

- Use the charger provided with the tool only to charge the battery.
- Never attempt to charge non-rechargeable batteries.
- Have defective cords replaced immediately.
- Do not expose to water.
- Do not open the charger.
- Do not probe the charger.
- The charger is intended for indoor use only.
- This charger can be used by children aged from 8 years and above and persons with reduced physical, sensory or mental capabilities or lack of experience and knowledge if they have been given supervision or instruction concerning use of the appliance in a safe way and understand the hazards involved.

- Children shall not play with the appliance. Cleaning and user maintenance shall not be made by children without supervision.
- If the supply cord is damaged, it must be replaced by the manufacturer, its service agent or similarly qualified persons in order to avoid a hazard.

CAUTION: Do not recharge non-rechargeable batteries.

Symbols

	Conforms to relevant safety standards
	To reduce the risk of injury, the user must read and understand this manual before using this product.
	Wear ear protectors. Exposure to noise can cause hearing loss.
	Wear eye protection.
	Class II, double isolation(only for charger)
	Do not dispose of old appliances with domestic rubbish
	Do not expose the charger or battery to water.
	Do not incinerate the battery or charger.
	Ambient temperature of 40 ° C max. (only for the battery)
	Use the battery and charger Indoor use only.
	Recycling

3. YOUR PRODUCT (Fig.1)

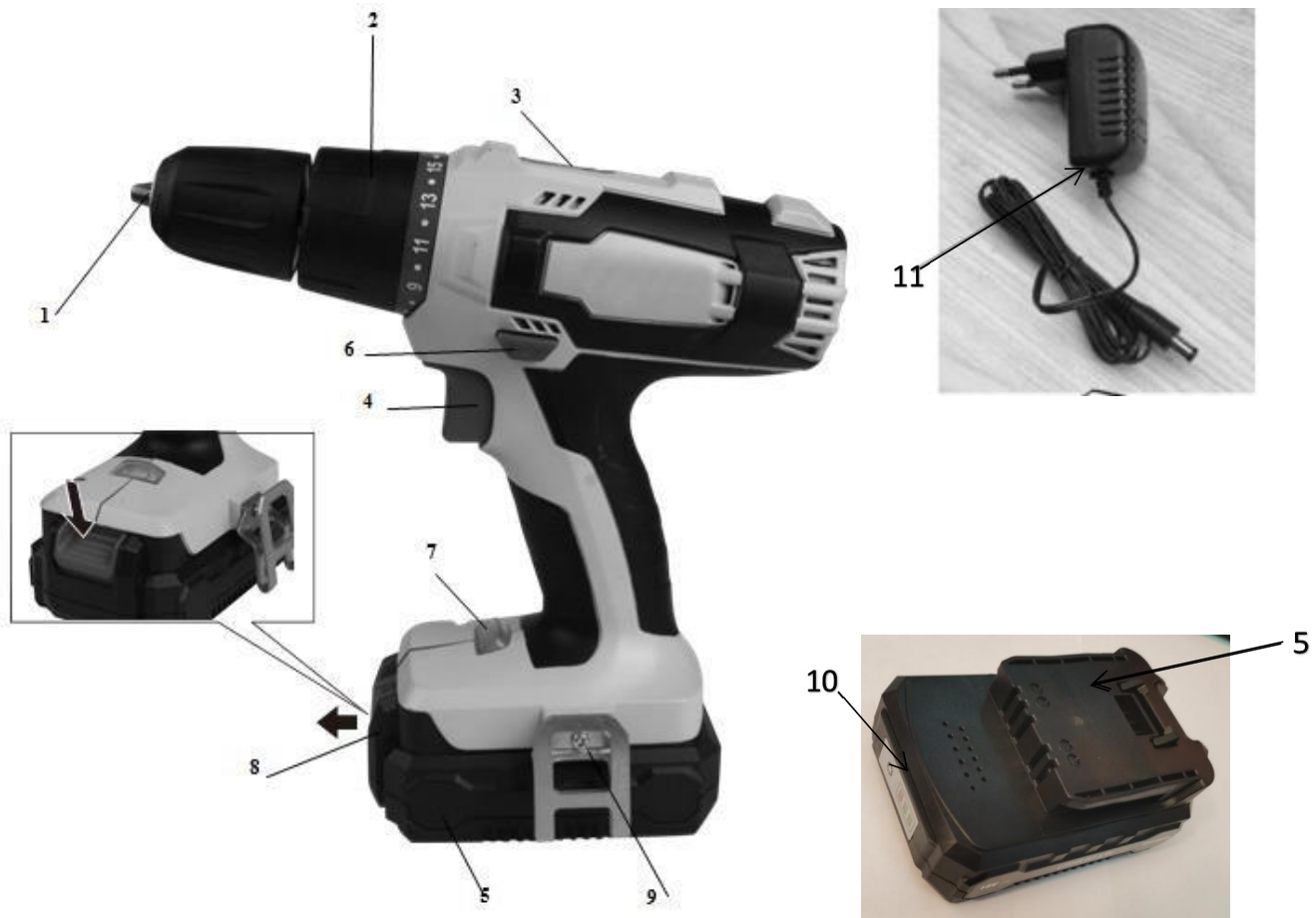

1. Keyless chuck
2. Torque adjustment ring
3. Two speed selector
4. On/off switch trigger
5. Battery pack
6. Forward/reverse knob
7. LED work light
8. Button for battery capacity indicator
9. Belt clip
10. Battery capacity indicator
11. Charger

4. FEATURES

4.1 Li-ion battery (5)

Advantages of Li-ion batteries:

- Li-ion batteries have a higher capacity/weight ratio (more power for less heavy, more compact, battery)
- No memory effect (capacity loss after several charge/discharge cycles) like other type batteries.
- Limited self-discharge.

4.2 Keyless chuck (1)

Your drill has a keyless chuck that allows you to hand tighten or release drill bit in the chuck jaws.

4.3 Torque adjustment ring (2)

The drill has a torque adjustment ring. It allows you to select the desired torque depending on the task you have to perform (screwing / different types of screws into different materials). The proper setting depends on the type of material and the size of screw you are using.

4.4 Forward/reverse selector (right/left rotation selector) (6)

The drill has a forward/reverse selector located above the switch trigger.

CAUTION: To prevent damage to the gearbox, always allow the chuck to come to a complete stop before changing the direction of rotation or selecting another speed (HIGH-LOW). To stop, release the trigger switch.

4.5 Variable speed

Your cordless drill has a variable speed switch. The rotational speed and torque will in-/ decrease equivalently to applied trigger pressure. This drill has an electric brake, when the trigger switch is released, the chuck stops turning.

4.6 Speed selector (3)

Your cordless drill has a two-speed gear, designed for drilling or driving at LOW (1) or HIGH (2) speed. A slide switch is located on top of your drill to select either LOW (1) or HIGH (2) speed.

4.7 LED light (7)

Your cordless drill is equipped with an LED light at the front, above the battery pack

4.8 TPR soft grip

Your cordless drill is equipped with TPR soft grip and protective parts. TPR (Thermoplastic rubber) is elastic, shock absorbing and environmental friendly (recyclable).

5. OPERATION

5.1 Charging the battery pack(Fig.2)

IMPORTANT: The battery pack is not fully charged at the factory.

Before attempting to charge them, thoroughly read all of the safety instructions.

- 1) To assure that the charger you use are applicable to the battery pack.
- 2) Insert the charger into 100-240V~,50-60Hz outlet. The indicator light (3) become to green light to show the power is connected.
- 3) Insert the end of charger(1) into the slot of battery(2). Make sure the contact with the charger is correct.
- 4) When charging The indicator light (3) become to red light.
- 5) When fully charged The indicator light (3) become to green light.



(Fig.2)

- 6).Frequently monitor the charger and battery pack while connected.
- 7).Unplug the charger and disconnect it from the battery pack when finished.
- 8).Allow the battery pack to cool completely before using it.
- 9).Store the charger and battery pack indoors, out of reach of children.



Note: If the battery does not fit properly, disconnect it and confirm that the battery pack is the correct model for this charger as shown on the specification chart. Do not charge any other battery pack or any battery pack that does not securely fit the charger.



NOTE: If battery is hot after continuous use in the tool, allow it to cool down to room temperature before charging. This will extend the life of your batteries.



Remove battery pack from charger stand which use your thumb or fingers, press the battery's release button in and pull the battery pack off at the same time.

Battery capacity indicator

There are battery capacity indicators on the battery pack; you can check the capacity status of the battery if you squeeze the button. Before using the machine, please press switch trigger to check if the battery is full enough for properly working.

Those 3 LED might show the status of the capacity level of the battery.

Inserting and removing the battery.



WARNING: Before making any adjustments ensure the drill is switched off with the direction of rotation selector in the center position

1. Remove the battery: press the battery release latch in and at the same time pull the battery pack off.
2. To insert the battery, push the battery pack onto the contacts of the tool.

5.2 Installing and Removing a Bit and a Drill (Fig.3)

This drill has a keyless chuck to prevent the bit or drill from loosening and allows you to hand tighten or release drill bit in the chuck jaws

1. Turn ring A anticlockwise with the other hand until the drill chuck opening is large enough to accept the tool.
2. Insert the drill or the screwdriver bit into the drill chuck.
3. Turn ring A clockwise until the tool is clamped tightly.
4. Remove the tool in the opposite way.

Fig 3

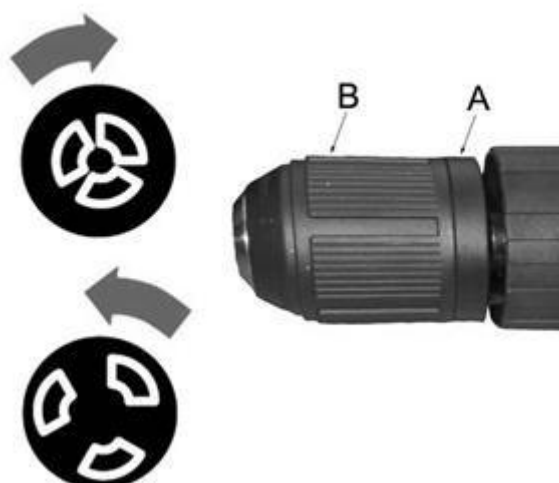

1) **Switch (4)**

The drill is started and stopped by depressing and releasing the ON/OFF switch trigger.

2) **Switch lock**

The switch trigger can be locked in the center position.

This helps to reduce the possibility of accidental starting when not in use. To lock the switch trigger, place the direction of rotation selector in the center position.

3) **Direction of rotation (Fig.4)**

Direction of rotation is controlled by the direction of rotation selector located above the switch trigger.

Fig 4

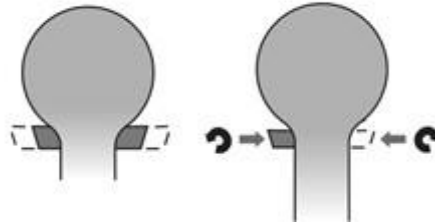

4) **Clockwise rotation:(Fig.4)**

Right: To select forward rotation, release the on/off switch and push the forward/reverse lever to the left side of the tool.

5) **Anticlockwise rotation:(Fig.4)**

Left: To select reverse rotation, push the lever to the right side of the tool.

6) **Variable speed**

This tool has a variable speed switch that delivers higher speed and torque with increased trigger pressure. Speed is controlled by the amount of switch trigger depression.

7) **Adjusting the torque**

The torque is adjusted by rotating the torque setting ring; the torque is greater when the torque setting is set on a higher position. The torque is less when the torque setting ring is set on a low position "1" denotes lowest and "19" denote highest.

Torque is set by means of a torque setting according to different screw and different material, you can adjust suitable torque, if the screw is long and material is hard, you can adjust the bigger setting.

8) **Speed selector**

The drill has a two-speed gear train designed for drilling at 1 (LOW) or 2 (HIGH) speed. A gear selector is located on top of the drill to select either low or high speed. When you push the button forward and select low speed range, the speed will decrease but will provide more power and torque. When using drill in the high-speed range. Speed will increase but will provide less power and torque. Use low speed for high power and torque application and high speed for fast drilling applications.



Important: NEVER adjust this two-speed selector whilst the drill is running. Always let it come to a complete stop first.

9) **LED light**

The LED work-light can light prior to motor running if you press the switch lightly, which keep the work area to be lighted for checking clearly at first, and it lights also during your operation.



WARNING: Do not stare directly at the light beam. Never aim the beam at any person or an object other than the work piece.



Do not deliberately aim the beam at personnel and ensure that it is not directed towards the eye of a person for longer than 0.25s.

10) DRILLING

(1) Drilling

Before use for drilling, set the torque

When drilling hard smooth surface, use a center punch to mark the desired hole location. This will prevent the drill bit from slipping off center as the hole is started. Hold the tool firmly and place the tip of the drill or bit into the work piece, applying only enough pressure to keep the bit cutting. Do not force or apply side pressure to elongate a hole.

(2) Wood drilling

For maximum performance, use high speed steel bits for wood drilling. Turn the function mode selector on

the drill mode “”. Begin drilling at a very low speed to prevent the bit from slipping off the starting point.

Increase the speed as the drill bit bites into the material. When drilling through holes, place a block of wood behind the workpiece to prevent ragged or sintered edges on the back side of the hole.

(3) Metal drilling

For maximum performance, use high speed steel bits for metal or steel drilling. Turn the function mode

selector on the drill mode “”. Begin drilling at a very low speed to prevent the bit from slipping off the starting point. Maintain a speed and pressure which allows cutting without overheating the bit.

Applying too much pressure will:

- Overheat the drill
- Wear the bearings
- Bend or burn bits
- Produce off-center or irregular shaped holes

When drilling large holes in metal, it is recommended that you drill with a small bit at first, then finish with a large bit. Also, lubricate the bit with oil to improve drilling action and increase bit life.

(4) Driving screw

-For maximum performance, use good quality bits for driving screws, turn the function mode selector on the screwdriver mode position “19”.

-Fix the torque setting low enough to allow a safety margin. Use a very low torque setting when first driving small screws into soft materials. Then adjust the setting as the proper force required is determined.



NOTE: The torque setting required depends on the item being driven. In the case of screws, consider the size, length, and type of material.

NOTE: Only use a masonry bit when drilling into masonry materials.

6. CLEANING AND MAINTENANCE

Cleaning

Keep the ventilation slots of the machine clean to prevent overheating of the engine.

Regularly clean the machine housing with a soft cloth, preferably after each use.

Keep the ventilation slots free from dust and dirt.

If the dirt does not come off use a soft cloth moistened with soapy water.

Never use solvents such as petrol, alcohol, ammonia water, etc. These solvents may damage the plastic parts.

Maintenance

Our machines have been designed to operate over a long period of time with a minimum of maintenance. Continuous satisfactory operation depends upon proper machine care and regular cleaning.

7. TECHNICAL DETAILS

Power supply	18 V d.c.
Chuck	10 mm keyless
Gear Train	2 Speed
No Load Speed	0-400/0-1600 min ⁻¹
Clutch	19+1 Positions
Charger type	HNHPACK18V Input 100-240V~ 50-60Hz, 19W Output 21V d.c., 0.5A
Battery type	HNHPACK18V 18V d.c. 1.5Ah Lithium-ion
Charging time	3-5 hours
Torque	40Nm (MAX.)
Acoustic pressure level LpA	LpA =66.3dB(A) Uncertainty: K=5 dB(A)
Acoustic power level LwA	L _{WA} =77.3dB(A) Uncertainty: K=5 dB(A)
aw (Vibration)	a _{h,D} : 2.8m/s ² , K=1.5m/s ² .

Information

- The declared vibration total value has been measured in accordance with a standard test method and may be used for comparing one tool with another;
- The declared vibration total value may also be used in a preliminary assessment of exposure.

Warning

- that the vibration emission during actual use of the power tool can differ from the declared total value depending on the ways in which the tool is used; and
 - of the need to identify safety measures to protect the operator that are based on an estimation of exposure in the actual conditions of use (taking account of all parts of the operating cycle such as the times when the tool is switched off and when it is running idle in addition to the trigger time).
- Wear hearing protection.

8. DISPOSAL



Electrical products should not be discarded with household products. According to the European Directive 2012/19/EU on waste electrical and electronic equipment and its implementation into national law, electrical products used must be collected separately and disposed of at collection points provided for this purpose. Talk with your local authorities or dealer for advice on recycling.

BATTERY PACK



This product contains Li-ion. To preserve natural resources, please recycle or dispose of batteries properly. Local, state or federal laws may prohibit disposal of Li-ion batteries in ordinary trash. Consult your local waste authority for information regarding available recycling and/or disposal options.

9. DECLARATION OF CONFORMITY

**BUILDER SAS****32 rue Aristide Bergès - Z.I. du Casque - 31270 Cugnaux - France**, declares that,

Product: Cordless Drill 18V

Trade mark: Hyundai

Model: HNHPACK18V

Serial number: 20230448288-20230448437

is in conformity with the essential requirements and other relevant provisions of the applicable European Directives, based on the application of European harmonized standards. Any unauthorized modification of the apparatus voids this declaration.

European Directives (including, if applicable, their amendments up to the date of signature);
Rohs directive 2011/65/EU + (EU) 2015/863

Directive Machine 2006/42/EC

Directive EMC 2014/30/UE; LVD Directive 2014/35/UE

European harmonized standards (including, if applicable, their amendments up to the date of signature);

EN62841-1 : 2015; EN62841-2-1: 2018+A11: 2019

EN55014-1 : 2017+A11:2020; EN55014-2 : 2015

EN 62233:2008**EN 60335-2-29:2004+A2:2010+A11:2018****EN 60335-1:2012+A11:2014+A13:2017+A1:2019+A2:2019+A14:2019**

EN ICE61000-3-2:2019; EN61000-3-3:2013+A1:2019

Cugnaux, 27/02/2023

Philippe MARIE / PDG

Responsible of the technical file: Mr Olivier Patriarca

3. 18V CORDLESS ANGLE GRINDER

1. APPLICATION

This machine is developed for grinding and roughing of metal and stone. With correct accessories the machine can also be used for brushing and sanding. It is not designed for commercial use.



WARNING! For your own safety, read this manual and the general safety instructions carefully before using the appliance. Your power tool should only be given to other users together with these instructions.

2. GENERAL POWER TOOL SAFETY WARNINGS



WARNING Read all safety warnings, instructions, illustrations and specifications provided with this power tool. Failure to follow all instructions listed below may result in electric shock, fire and/or serious injury.

Save all warnings and instructions for future reference.

The term "power tool" in the warnings refers to your mains-operated (corded) power tool or battery-operated (cordless) power tool.

1) Work area safety

- a) **Keep work area clean and well lit.** Cluttered or dark areas invite accidents.
- b) **Do not operate power tools in explosive atmospheres, such as in the presence of flammable liquids, gases or dust.** Power tools create sparks which may ignite the dust or fumes.
- c) **Keep children and bystanders away while operating a power tool.** Distractions can cause you to lose control.

2) Electrical safety

- a) **Power tool plugs must match the outlet. Never modify the plug in any way. Do not use any adapter plugs with earthed (grounded) power tools.** Unmodified plugs and matching outlets will reduce risk of electric shock.
- b) **Avoid body contact with earthed or grounded surfaces, such as pipes, radiators, ranges and refrigerators.** There is an increased risk of electric shock if your body is earthed or grounded.
- c) **Do not expose power tools to rain or wet conditions.** Water entering a power tool will increase the risk of electric shock.
- d) **Do not abuse the cord. Never use the cord for carrying, pulling or unplugging the power tool. Keep cord away from heat, oil, sharp edges or moving parts.** Damaged or entangled cords increase the risk of electric shock.
- e) **When operating a power tool outdoors, use an extension cord suitable for outdoor use.** Use of a cord suitable for outdoor use reduces the risk of electric shock.
- f) **If operating a power tool in a damp location is unavoidable, use a residual current device (RCD) protected supply.** Use of an RCD reduces the risk of electric shock.

3) Personal safety

- a) **Stay alert, watch what you are doing and use common sense when operating a power tool. Do not use a power tool while you are tired or under the influence of drugs, alcohol or medication.** A moment of inattention while operating power tools may result in serious personal injury.
- b) **Use personal protective equipment. Always wear eye protection.** Protective equipment such as a dust mask, non-skid safety shoes, hard hat or hearing protection used for appropriate conditions will reduce personal injuries.

- c) **Prevent unintentional starting. Ensure the switch is in the off-position before connecting to power source and/or battery pack, picking up or carrying the tool.** *Carrying power tools with your finger on the switch or energising power tools that have the switch on invites accidents.*
- d) **Remove any adjusting key or wrench before turning the power tool on.** *A wrench or a key left attached to a rotating part of the power tool may result in personal injury.*
- e) **Do not overreach. Keep proper footing and balance at all times.** *This enables better control of the power tool in unexpected situations.*
- f) **Dress properly. Do not wear loose clothing or jewellery. Keep your hair and clothing away from moving parts.** *Loose clothes, jewellery or long hair can be caught in moving parts.*
- g) **If devices are provided for the connection of dust extraction and collection facilities, ensure these are connected and properly used.** *Use of dust collection can reduce dust-related hazards.*
- h) **Do not let familiarity gained from frequent use of tools allow you to become complacent and ignore tool safety principles.** *A careless action can cause severe injury within a fraction of a second.*

4) Power tool use and care

- a) **Do not force the power tool. Use the correct power tool for your application.** *The correct power tool will do the job better and safer at the rate for which it was designed.*
- b) **Do not use the power tool if the switch does not turn it on and off.** *Any power tool that cannot be controlled with the switch is dangerous and must be repaired.*
- c) **Disconnect the plug from the power source and/or remove the battery pack, if detachable, from the power tool before making any adjustments, changing accessories, or storing power tools.** *Such preventive safety measures reduce the risk of starting the power tool accidentally.*
- d) **Store idle power tools out of the reach of children and do not allow persons unfamiliar with the power tool or these instructions to operate the power tool.**
Power tools are dangerous in the hands of untrained users.
- e) **Maintain power tools and accessories. Check for misalignment or binding of moving parts, breakage of parts and any other condition that may affect the power tool's operation. If damaged, have the power tool repaired before use.** *Many accidents are caused by poorly maintained power tools.*
- f) **Keep cutting tools sharp and clean.** *Properly maintained cutting tools with sharp cutting edges are less likely to bind and are easier to control.*
- g) **Use the power tool, accessories and tool bits etc. in accordance with these instructions, taking into account the working conditions and the work to be performed.** *Use of the power tool for operations different from those intended could result in a hazardous situation.*
- h) **Keep handles and grasping surfaces dry, clean and free from oil and grease.** *Slippery handles and grasping surfaces do not allow for safe handling and control of the tool in unexpected situations.*

5) Battery tool use and care

- a) **Recharge only with the charger specified by the manufacturer.** *A charger that is suitable for one type of battery pack may create a risk of fire when used with another battery pack.*
- b) **Use power tools only with specifically designated battery packs.** *Use of any other battery packs may create a risk of injury and fire.*
- c) **When battery pack is not in use, keep it away from other metal objects, like paper clips, coins, keys, nails, screws or other small metal objects, that can make a connection from one terminal to another.** *Shorting the battery terminals together may cause burns or a fire.*
- d) **Under abusive conditions, liquid may be ejected from the battery; avoid contact. If contact accidentally occurs, flush with water. If liquid contacts eyes, additionally seek medical help.** *Liquid ejected from the battery may cause irritation or burns.*
- e) **Do not use a battery pack or tool that is damaged or modified.** *Damaged or modified batteries may exhibit unpredictable behaviour resulting in fire, explosion or risk of injury.*

f) **Do not expose a battery pack or tool to fire or excessive temperature.** *Exposure to fire or temperature above 130 °C may cause explosion.*

NOTE The temperature „130 °C“ can be replaced by the temperature „265 °F“.

g) **Follow all charging instructions and do not charge the battery pack or tool outside the temperature range specified in the instructions.** *Charging improperly or at temperatures outside the specified range may damage the battery and increase the risk of fire.*

6) Service

a) **Have your power tool serviced by a qualified repair person using only identical replacement parts.** *This will ensure that the safety of the power tool is maintained.*

b) **Never service damaged battery packs.** *Service of battery packs should only be performed by the manufacturer or authorized service providers.*

Safety instructions for all operations

Safety Warnings Common for Grinding, Sanding, Wire Brushing, Polishing or Abrasive Cutting-Off Operations:

a) **This power tool is intended to function as a grinder and cut-off tool. Read all safety warnings, instructions, illustrations and specifications provided with this power tool.** *Failure to follow all instructions listed below may result in electric shock, fire and/or serious injury.*

b) **Operations such as sanding, wire brushing and polishing are not recommended to be performed with this power tool.** *Operations for which the power tool was not designed may create a hazard and cause personal injury.*

c) **Do not use accessories which are not specifically designed and recommended by the tool manufacturer.** *Just because the accessory can be attached to your power tool, it does not assure safe operation.*

d) **The rated speed of the accessory must be at least equal to the maximum speed marked on the power tool.** *Accessories running faster than their rated speed can break and fly apart.*

e) **The outside diameter and the thickness of your accessory must be within the capacity rating of your power tool.** *Incorrectly sized accessories cannot be adequately guarded or controlled.*

f) **Threaded mounting of accessories must match the grinder spindle thread. For accessories mounted by flanges, the arbour hole of the accessory must fit the locating diameter of the flange.** *Accessories that do not match the mounting hardware of the power tool will run out of balance, vibrate excessively and may cause loss of control.*

g) **Do not use a damaged accessory. Before each use inspect the accessory such as abrasive wheels for chips and cracks, backing pad for cracks, tear or excess wear, wire brush for loose or cracked wires. If power tool or accessory is dropped, inspect for damage or install an undamaged accessory. After inspecting and installing an accessory, position yourself and bystanders away from the plane of the rotating accessory and run the power tool at maximum no-load speed for one minute.**

Damaged accessories will normally break apart during this test time.

h) **Wear personal protective equipment. Depending on application, use face shield, safety goggles or safety glasses. As appropriate, wear dust mask, hearing protectors, gloves and workshop apron capable of stopping small abrasive or workpiece fragments.** *The eye protection must be capable of stopping flying debris generated by various operations. The dust mask or respirator must be capable of filtrating particles generated by your operation. Prolonged exposure to high intensity noise may cause hearing loss.*

i) **Keep bystanders a safe distance away from work area. Anyone entering the work area must wear personal protective equipment.** *Fragments of workpiece or of a broken accessory may fly away and cause injury beyond immediate area of operation.*

j) **Hold the power tool by insulated gripping surfaces only, when performing an operation where the**

cutting accessory may contact hidden wiring or its own cord.

Cutting accessory contacting a "live" wire may make exposed metal parts of the power tool "live" and could give the operator an electric shock.

k) **Position the cord clear of the spinning accessory.** *If you lose control, the cord may be cut or snagged and your hand or arm may be pulled into the spinning accessory.*

l) **Never lay the power tool down until the accessory has come to a complete stop.** *The spinning accessory may grab the surface and pull the power tool out of your control.*

m) **Do not run the power tool while carrying it at your side.** *Accidental contact with the spinning accessory could snag your clothing, pulling the accessory into your body.*

n) **Regularly clean the power tool's air vents.** *The motor's fan will draw the dust inside the housing and excessive accumulation of powdered metal may cause electrical hazards.*

o) **Do not operate the power tool near flammable materials.** *Sparks could ignite these materials.*

p) **Do not use accessories that require liquid coolants.** *Using water or other liquid coolants may result in electrocution or shock.*

Further safety instructions for all operations

Kickback and Related Warnings

Kickback is a sudden reaction to a pinched or snagged rotating wheel, backing pad, brush or any other accessory. Pinching or snagging causes rapid stalling of the rotating accessory which in turn causes the uncontrolled power tool to be forced in the direction opposite of the accessory's rotation at the point of the binding.

For example, if an abrasive wheel is snagged or pinched by the workpiece, the edge of the wheel that is entering into the pinch point can dig into the surface of the material causing the wheel to climb out or kick out. The wheel may either jump toward or away from the operator, depending on direction of the wheel's movement at the point of pinching. Abrasive wheels may also break under these conditions.

Kickback is the result of power tool misuse and/or incorrect operating procedures or conditions and can be avoided by taking proper precautions as given below.

a) **Maintain a firm grip on the power tool and position your body and arm to allow you to resist kickback forces. Always use auxiliary handle, if provided, for maximum control over kickback or torque reaction during start-up.** *The operator can control torque reactions or kickback forces, if proper precautions are taken.*

b) **Never place your hand near the rotating accessory.** *Accessory may kickback over your hand.*

c) **Do not position your body in the area where power tool will move if kickback occurs.** *Kickback will propel the tool in direction opposite to the wheel's movement at the point of snagging.*

d) **Use special care when working corners, sharp edges etc. Avoid bouncing and snagging the accessory.** *Corners, sharp edges or bouncing have a tendency to snag the rotating accessory and cause loss of control or kickback.*

e) **Do not attach a saw chain woodcarving blade or toothed saw blade.** *Such blades create frequent kickback and loss of control.*

Additional safety instructions for grinding and cutting-off operations

Safety Warnings Specific for Grinding and Abrasive Cutting-Off Operations:

a) **Use only wheel types that are recommended for your power tool and the specific guard designed for the selected wheel.** *Wheels for which the power tool was not designed cannot be adequately guarded and are unsafe.*

b) **The grinding surface of centre depressed wheels must be mounted below the plane of the guard lip.** *An improperly mounted wheel that projects through the plane of the guard lip cannot be adequately protected.*

c) **The guard must be securely attached to the power tool and positioned for maximum safety, so the least amount of wheel is exposed towards the operator.** *The guard helps to protect the operator from*

broken wheel fragments, accidental contact with wheel and sparks that could ignite clothing.

d) Wheels must be used only for recommended applications. For example: do not grind with the side of cut-off wheel. *Abrasive cut-off wheels are intended for peripheral grinding, side forces applied to these wheels may cause them to shatter.*

e) Always use undamaged wheel flanges that are of correct size and shape for your selected wheel. *Proper wheel flanges support the wheel thus reducing the possibility of wheel breakage. Flanges for cut-off wheels may be different from grinding wheel flanges.*

f) Do not use worn down wheels from larger power tools. *Wheel intended for larger power tool is not suitable for the higher speed of a smaller tool and may burst.*

Additional safety instructions for cutting-off operations

Additional Safety Warnings Specific for Abrasive Cutting-Off Operations:

a) Do not “jam” the cut-off wheel or apply excessive pressure. Do not attempt to make an excessive depth of cut. *Overstressing the wheel increases the loading and susceptibility to twisting or binding of the wheel in the cut and the possibility of kickback or wheel breakage.*

b) Do not position your body in line with and behind the rotating wheel. *When the wheel, at the point of operation, is moving away from your body, the possible kickback may propel the spinning wheel and the power tool directly at you.*

c) When wheel is binding or when interrupting a cut for any reason, switch off the power tool and hold the power tool motionless until the wheel comes to a complete stop. Never attempt to remove the cut-off wheel from the cut while the wheel is in motion otherwise kickback may occur. *Investigate and take corrective action to eliminate the cause of wheel binding.*

d) Do not restart the cutting operation in the workpiece. Let the wheel reach full speed and carefully re-enter the cut. *The wheel may bind, walk up or kickback if the power tool is restarted in the workpiece.*

e) Support panels or any oversized workpiece to minimize the risk of wheel pinching and kickback. *Large workpieces tend to sag under their own weight. Supports must be placed under the workpiece near the line of cut and near the edge of the workpiece on both sides of the wheel.*

f) Use extra caution when making a “pocket cut” into existing walls or other blind areas. *The protruding wheel may cut gas or water pipes, electrical wiring or objects that can cause kickback.*

SPECIFIC SAFETY INSTRUCTIONS FOR ANGLE GRINDERS

- Check that the maximum speed indicated on the grinding disc corresponds to the maximum speed of the machine. The speed of the machine must not exceed the value on the grinding disc.
- Make sure that the dimensions of the grinding disc correspond to the specifications of the machine.
- Make sure that the grinding disc has been mounted and fastened properly. Do not use reducing rings or adapters to make the grinding disc fit properly.
- Treat and store grinding discs in conformance with the supplier’s instructions.
- Do not use the machine for grinding workpieces with a maximum thickness exceeding the maximum grinding depth of the grinding disc.
- Do not use grinding discs for deburring.
- When grinding discs have to be mounted on the thread of the spindle, make sure that the spindle has sufficient thread. Make sure that the spindle is sufficiently protected and does not touch the grinding surface.
- Before use, inspect the grinding disc for any damage. Do not use grinding discs which are cracked, ripped or otherwise damaged.
- Before use, let the machine run idle for 30 seconds.
- Immediately switch off the machine in case of abnormal vibrations or occurrence of another defect. Carefully inspect the machine and grinding disc before switching the machine on again.
- Make sure that sparks do not put people into danger or that they contact highly flammable substances.

- Make sure that the workpiece is sufficiently supported or clamped. Keep your hands away from the surface to be cut.
- Always wear safety goggles and hearing protection. If desired or required also use another kind of protection like for example an apron or helmet.
- Ensure that mounted wheels and points are fitted in accordance with the manufacturer's instructions.
- Ensure that blotters are used when they are provided with the bonded abrasive product and when they are required.
- If a guard is supplied with the tool never use the tool without such a guard.
- For tools intended to be fitted with threaded hole wheel, ensure that the thread in the wheel is long enough to accept the spindle length.
- Ensure that ventilation openings are kept clear when working in dusty conditions.

SAFETY INSTRUCTIONS FOR BATTERIES AND CHARGER

Batteries

- Never attempt to open for any reason.
- Do not store in locations where the temperature may exceed 40°C (104°F).
- Charge only at ambient temperatures between 4°C and 40°C (39.2°F and 104°F).
- Charge only using the charger provided with the tool.
- Store your batteries in a cool dry place (5°C-20°C/41°F-68°F). Never store batteries in discharged state.
- It is better for Li-ion batteries to discharge and reload them regularly (at least 4 times a year). The ideal charge for long-term storage of your Li-ion battery is 40% of capacity.
- When disposing of batteries, follow the instructions given in the section "Protecting the environment".
- Do not cause short circuits. If connection is made between the positive (+) and negative (-) terminal directly or via accidental contact with metallic objects, the battery is short circuited and an intense current will flow causing heat generation which may lead to casing rupture or fire.
- Do not heat. If batteries are heated to above 100°C (212°F), sealing and insulating separators and other polymer components may be damaged resulting in electrolyte leakage and/or internal short circuiting leading to heat generation causing rupture or fire. Moreover do not dispose of the batteries in fire, explosion and/or intense burning may result.
- Under extreme conditions, battery leakage may occur. When you notice liquid on the battery, proceed as follows:
 - ✓ Carefully wipe the liquid off using a cloth. Avoid skin contact.
 - ✓ In case of skin or eye contact, follow the instructions below:
 - Immediately rinse with water. Neutralize with a mild acid such as lemon juice or vinegar.
 - In case of eye contact, rinse abundantly with clean water for at least 10 minutes. Consult a physician.











Fire hazard! Avoid short-circuiting the contacts of a detached battery. Do not incinerate the battery.

Charger

- . Use the charger provided with the tool only to charge the battery.
- . Never attempt to charge non-rechargeable batteries.
- . Have defective cords replaced immediately.
- . Do not expose to water.
- . Do not open the charger.
- . Do not probe the charger.
- . The charger is intended for indoor use only.
- . This charger can be used by children aged from 8 years and above and persons with reduced physical, sensory or mental capabilities or lack of experience and knowledge if they have been given supervision or instruction concerning use of the appliance in a safe way and understand the hazards involved.
- . Children shall not play with the appliance. Cleaning and user maintenance shall not be made by children without supervision.
- . If the supply cord is damaged, it must be replaced by the manufacturer, its service agent or similarly qualified persons in order to avoid a hazard.

CAUTION: Do not recharge non-rechargeable batteries.

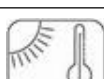
Symbols

	<p>Conforms to relevant safety standards</p>
	<p>To reduce the risk of injury, the user must read and understand this manual before using this product.</p>
	<p>Wear eye protection.</p>
	<p>Do not dispose of old appliances with domestic rubbish</p>
	<p>Class II, double isolation(only for charger)</p>
	<p>Do not expose the charger or battery to water.</p>
	<p>Do not incinerate the battery or charger.</p>
	<p>Ambient temperature of 40 °C max. (only for the battery)</p>
	<p>Use the battery and charger Indoor use only.</p>
	<p>Recycling</p>

3. YOUR PRODUCT

FIG. A

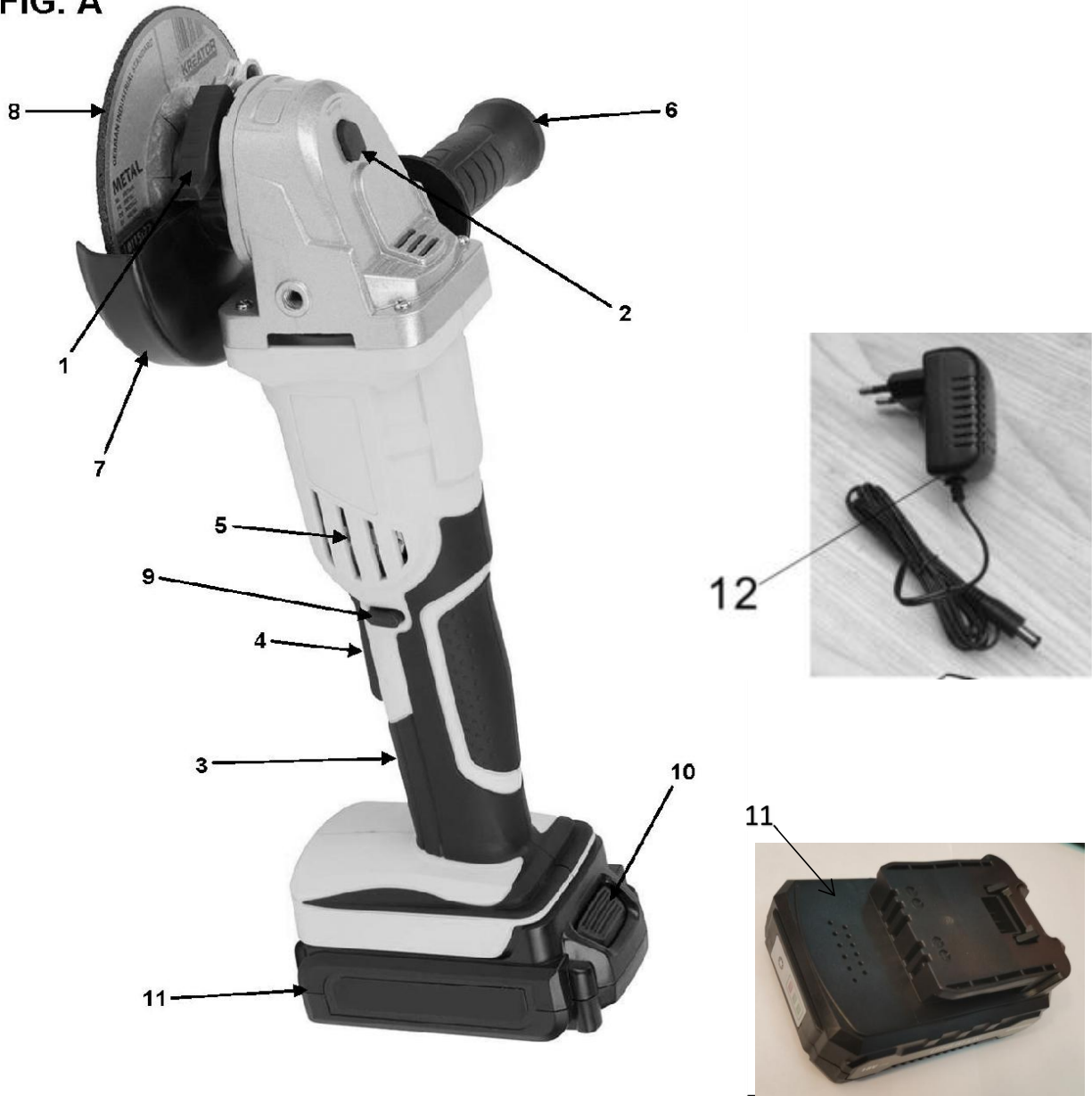

Fig A:

- 1. Lock lever for protection guard
- 2. Spindle lock button
- 3. Main handle
- 4. On/Off switch
- 5. Air vents
- 6. Auxiliary handle
- 7. Guard
- 8. Grinding disc (not included)
- 9. Lock button
- 10. Release button
- 11. Battery pack
- 12. Charger

Fig 1

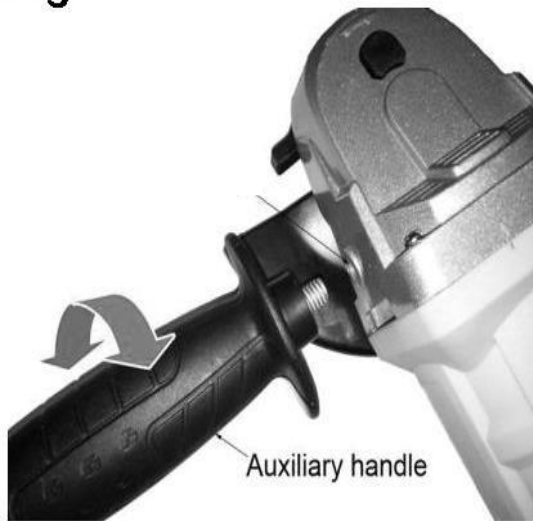

Fig. 6

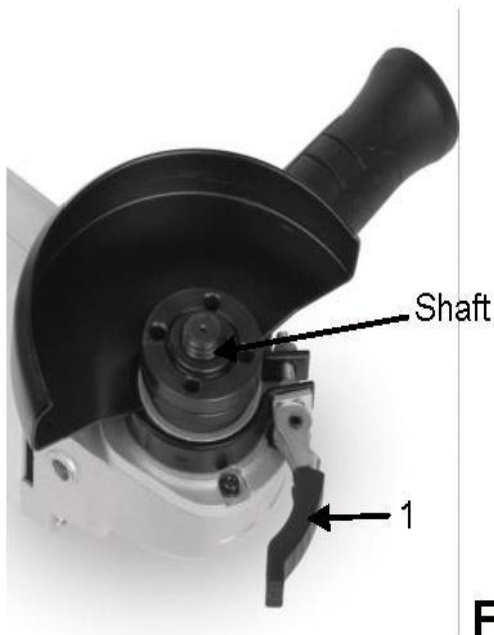

Fig.2

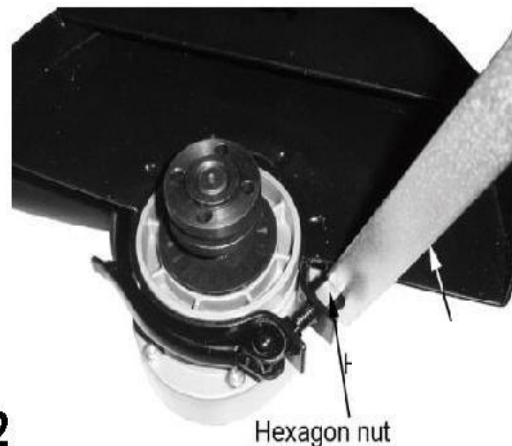

Fig.3

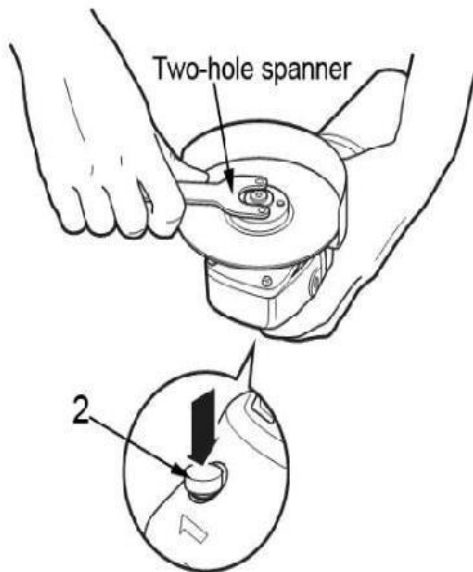

Fig.4

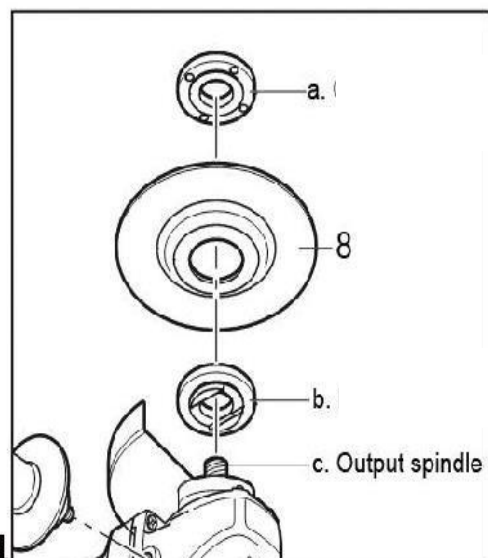

Fig.5

4. PACKAGE CONTENT LIST

- Remove all packaging materials.
- Remove remaining packaging and packing inserts (if included).
- Check that the package contents are complete.
- Check the appliance, the power cord, the power plug of charger and all accessories for transportation damage or not.
- Keep the packaging materials as far as possible until the end of the warranty period. Then take it to your local waste disposal system.



WARNING! Packaging materials are not toys! Children must not play with plastic bags! There is a danger of suffocation!

- 1 x angle grinder
- 1 x auxiliary handle
- 1 x pin spanner
- 1 x instruction manual

Note: If any parts are missing or damaged, please contact your dealer.

5. OPERATION

5.1 Charging the battery pack

IMPORTANT: The battery pack is not fully charged at the factory. Before attempting to charge them, thoroughly read all of the safety instructions.

- 1) To assure that the charger you use are applicable to the battery pack.
- 2) Insert the charger into 100-240V~,50-60Hz outlet. The indicator light (3) become to green light to show the power is connected.
- 3) Insert the end of charger(1) into the slot of battery(2). Make sure the contact with the charger is correct.
- 4) When charging The indicator light (3) become to red light.
- 5) When fully charged The indicator light (3) become to green light.



- 6).Frequently monitor the charger and battery pack while connected.
- 7).Unplug the charger and disconnect it from the battery pack when finished.
- 8).Allow the battery pack to cool completely before using it.
- 9).Store the charger and battery pack indoors, out of reach of children.



Note: If the battery does not fit properly, disconnect it and confirm that the battery pack is the correct model for this charger as shown on the specification chart. Do not charge any other

battery pack or any battery pack that does not securely fit the charger.



NOTE: If battery is hot after continuous use in the tool, allow it to cool down to room temperature before charging. This will extend the life of your batteries.



Remove battery pack from charger stand which use your thumb or fingers, press the battery's release button in and pull the battery pack off at the same time.

Battery capacity indicator

There are battery capacity indicators on the battery pack; you can check the capacity status of the battery if you squeeze the button. Before using the machine, please press switch trigger to check if the battery is full enough for properly working.

Those 3 LED might show the status of the capacity level of the battery: Inserting and removing the battery.



WARNING: Before making any adjustments ensure the drill is switched off with the direction of rotation selector in the center position

1. Remove the battery: press the battery release latch in and at the same time pull the battery pack off.
2. To insert the battery, push the battery pack onto the contacts of the tool.

5.2 Fitting the auxiliary handle (Fig. 1)

The auxiliary handle (6) can be attached to the angle grinder in 3 different positions: left and right and top of head.

5.3 Assembly the protective guard (Fig. 2 – 3)

1. Loosen the clip of the protective guard (7) by pulling lock lever of protective guard (1) outward.
2. Turn the protective guard so that uncovered part of the disc is as far apart as possible from the hand on main handle (3).
3. Fix the protection guard by pushing the lock lever inwards (the protective guard should no longer be able to move).

NOTE: If the protective guard can not be fixed firmly by the lock lever (1), use a hexagon wrench to tighten the hexagon nut.

5.4 Replacing the grinding disc (Fig. 4 – 5)



Beware – a disc which has been used may be very hot!

- Depress and hold down the spindle lock button (2) to secure the spindle.
- Turn the shaft until it locks.
- Remove the outer flange (a) and backing flange (b) by using the two-hole spanner provided.
- Fit the desired disc (8) on the spindle and replace the outer flange and backing flange. Release the spindle lock.



Important! Only ever press the spindle lock when the motor and grinding spindle are at a standstill!

You must keep the spindle lock pressed while you change the wheel !

For grinding wheels up to approx. 3 mm thick, screw on the flange nut with the flat side facing the grinding wheel.

5.5 Switching on / off (Fig. 6)



Before engage the ON/OFF switch button, check that the grinding disc is properly fitted and run smoothly, the outer flange is well tightened.

- Connect the battery pack to the body of the angle grinder.
- To turn on the angle grinder, push the lock button (9) to the left or right and press the trigger of the ON / OFF switch (4).
- When you release the trigger, the tool turns off.
- Do not let go of the grinder until it is running.

OPERATON MODES

Grinding

Hold the handle (3) and auxiliary handle (6) firmly and switch on. Avoid blocking the ventilation slots with your hand, as this may cause the grinder to overheat. Let the disc reach full speed. Apply the grinder to the item. Maximum effect is achieved when the grinder is held at an angle of 15-30° in relation to the item. Move the grinder gently along the item. Give the grinder time to work. It is rarely necessary to press the disc hard against the surface to be worked. Sparks can occur in the motor compartment during use. This is normal and does not mean the grinder is defective. Switch off the grinder after use.

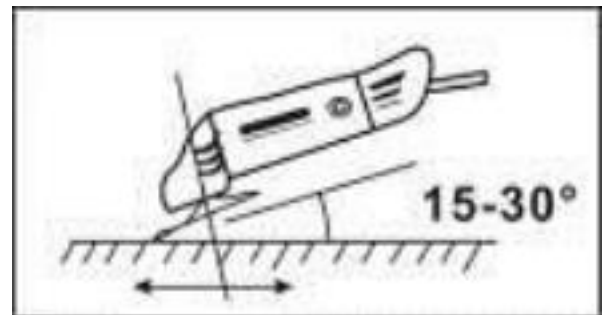

FLANGE ARRANGEMENTS WHEN USING GRINDING WHEELS

Flange arrangements when using a depressed centre or straight grinding wheel.

1 Clamping flange

2 Flange nut

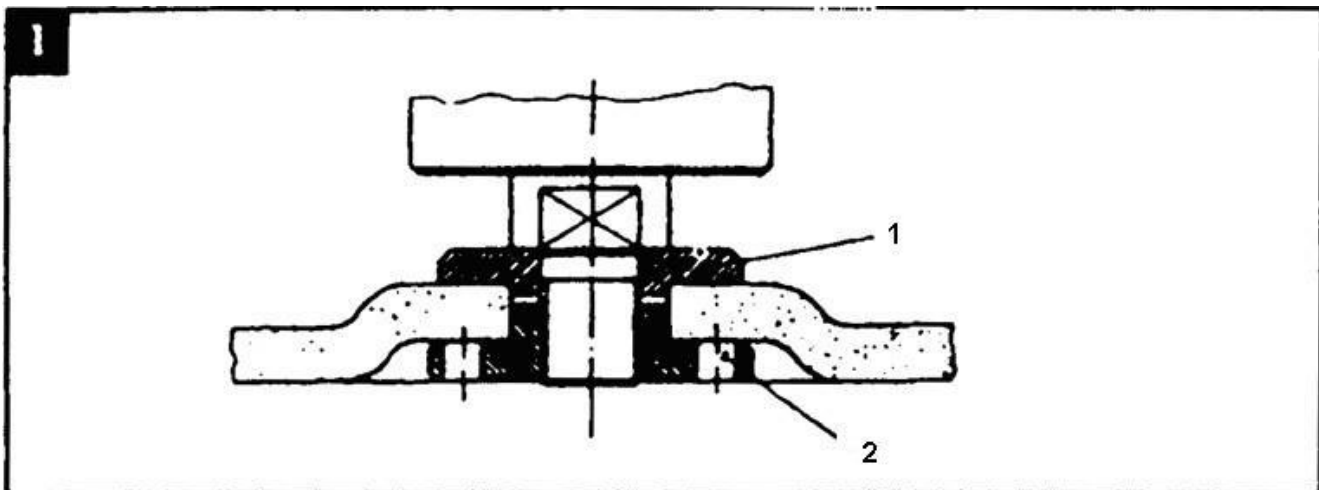

6. CLEANING AND MAINTENANCE



Always disconnect the battery pack from the angle grinder before making any adjustment or attaching any accessories.

6.1 Cleaning

- Keep the ventilation slots of the machine clean to prevent overheating of the engine.
- Regularly clean the machine housing with a soft cloth, preferably after each use.
- Keep the ventilation slots free from dust and dirt.
- If the dirt does not come off use a soft cloth moistened with soapy water.



Never use solvents such as petrol, alcohol, ammonia water, etc. These solvents may damage the plastic parts.

6.2 Lubrication

- The machine does not require any specific lubrication.

7. TECHNICAL DATA

Rated voltage (direct current)	18V d.c.
Rotation speed	8500/min
Max. disc diameter	Ø 115mm
Drive spindle thread	M 14
Battery type	HNHPACK18V 18V d.c. 1.5Ah, Lithium-ion
Charger type	HNHPACK18V Input 100-240V~ 50-60Hz, 19W Output 21V d.c., 0.5A
Charging time	3-5 hours
Sound pressure level	L_{pA} 79.1 dB(A), K= 3 dB(A)
Sound power level	L_{WA} 90.1 dB(A), K= 3 dB(A)
Ah, AG(Vibrations):	$a_{h,AG}$: 3,92 m/s ² ; K: 1,5 m/s ²

Information

- The declared vibration total value has been measured in accordance with a standard test method and may be used for comparing one tool with another;
- The declared vibration total value may also be used in a preliminary assessment of exposure.

Warning

- that the vibration emission during actual use of the power tool can differ from the declared total value depending on the ways in which the tool is used; and
- of the need to identify safety measures to protect the operator that are based on an estimation of exposure in the actual conditions of use (taking account of all parts of the operating cycle such as the times when the tool is switched off and when it is running idle in addition to the trigger time).

Wear hearing protection.

8. SERVICE DEPARTMENT

- Damaged switches must be replaced by our after-sales service department.
- If the connecting cable (or mains plug) is damaged, it must be replaced by a special connecting cable which is available from our service department. Replacement of the connecting cable should only be carried out by our service department (see last page) or by a qualified specialist (qualified electrician).

9. STORAGE

- Thoroughly clean the whole machine and its accessories.
- Store it out of the reach of children, in a stable and secure position, in a cool and dry place, avoid too high and too low temperatures.
- Protect it from exposure to direct sunlight. Keep it in the dark, if possible.
- Don't keep it in plastic bags to avoid humidity build-up.

10. DISPOSAL



Electrical products should not be discarded with household products. According to the European Directive 2012/19/EU on waste electrical and electronic equipment and its implementation into national law, electrical products used must be collected separately and disposed of at collection points provided for this purpose. Talk with your local authorities or dealer for advice on recycling.



Li-ion BATTERY PACK

This product contains Li-ion. To preserve natural resources, please recycle or dispose of batteries properly. Local, state or federal laws may prohibit disposal of Li-ion batteries in ordinary trash. Consult you local waste authority for information regarding available recycling and/or disposal options.

11. DELARATION OF CONFORMITY

**BUILDER SAS**

32 rue Aristide Bergès - Z.I. du Casque - 31270 Cugnaux - France, declares that,

Product: Angle Grinder 18V

Trade mark: Hyundai

Model: HNHPACK18V

Serial number: 20230448288-20230448437

is in conformity with the essential requirements and other relevant provisions of the applicable European Directives, based on the application of European harmonized standards. Any unauthorized modification of the apparatus voids this declaration.

European Directives (including, if applicable, their amendments up to the date of signature);

Rohs directive 2011/65/EU + (EU) 2015/863

2014/30/EU

2006/42/EC

LVD Directive 2014/35/UE

European harmonized standards

EN 60745-1:2009+A11:2010

EN60745-2-3:2011+A2:2013+A11:2014+A12:2014+A13:2015

EN55014-1:2017+A11:2020; EN55014-2 :2015

EN 62233:2008

EN 60335-2-29:2004+A2:2010+A11:2018

EN 60335-1:2012+A11:2014+A13:2017+A1:2019+A2:2019+A14:2019

EN ICE61000-3-2:2019; EN61000-3-3:2013+A1:2019

Cugnaux, 27/02/2023

Philippe MARIE / PDG

Responsible of the technical file: Mr Olivier Patriarca

4. WARRANTY

HYUNDAI

WARRANTY

The manufacturer guarantees the product against defects in material and workmanship for a period of 2 years from the date of the original purchase. The warranty only applies if the product is for household use. The warranty does not cover breakdowns due to normal wear and tear.

The manufacturer agrees to replace parts identified as defective by the designated distributor. The manufacturer does not accept responsibility for the replacement of the machine, in whole or in part, and/or ensuing damage.

The warranty does not cover breakdowns due to:

- insufficient maintenance.
- abnormal assembly, adjustment or operations of the product.
- parts subject to normal wear and tear.

The warranty does not extend to:

- shipping and packaging costs.
- using the tool for a purpose other than that for which it was designed.
- the use and maintenance of the machine done in a manner not described in the user manual.

Due to our policy of continuous product improvement, we reserve the right to alter or change specifications without notice. Consequently, the product may be different from the information contained therein, but a modification will be undertaken without notice if it is recognized as an improvement of the preceding characteristic.

READ THE MANUAL CAREFULLY BEFORE USING THE MACHINE.

When ordering spare parts, please indicate the part number or code, you can find this in the spare parts list in this manual. Keep the purchase receipt; without it, the warranty is invalid. To help you with your product, we invite you to contact us by phone or via our website:

- **+33 (0)9.70.75.30.30**
- **<https://services.swap-europe.com/contact>**

You must create a "ticket" via the web platform.

- Register or create your account.
- Indicate the reference of the tool.
- Choose the subject of your request.
- Describe your problem.
- Attach these files: invoice or sales receipt, photo of the identification plate (serial number), photo of the part you need (for example: pins on the transformer plug which are broken).



5. PRODUCT FAILURE

WHAT TO DO IF MY MACHINE BREAKS DOWN?

If you bought your product in a store:

- a) Empty the fuel tank if your product has one.
- b) Make sure that your machine is complete with all accessories supplied, and clean! If this is not the case, the repairer will refuse the machine.

Go to the store with the complete machine and with the receipt or invoice.

If you bought your product on a website:

- a) Empty the fuel tank if your product has one..
- b) Make sure that your machine is complete with all accessories supplied, and clean! If this is not the case, the repairer will refuse the machine.
- c) Create a SWAP-Europe service ticket on the site: <https://services.swap-europe.com> When making the request on SWAP-Europe, you must attach the invoice and the photo of the nameplate (serial number).
- d) Contact the repair station to make sure it is available before dropping off the machine.

Go to the repair station with the complete machine packed, accompanied by the purchase invoice and the station support sheet downloadable after the service request is completed on the SWAP-Europe site

For machines with engine failure from manufacturers BRIGGS & STRATTON, HONDA and RATO, please refer to the following instructions.

Repairs will be done by approved engine manufacturers of these manufacturers, see their site:

- <http://www.briggsandstratton.com/eu/fr>
- <http://www.honda-engines-eu.com/fr/service-network-page;jsessionid=5EE8456CF39CD572AA2AEEDFD290CDAE>
- <https://www.rato-europe.com/it/service-network>

Please keep your original packaging to allow for after-sales service returns or pack your machine with a similar cardboard box of the same dimensions.

For any question concerning our after-sales service you can make a request on our website <https://services.swap-europe.com>

Our hotline remains available at +33 (9) 70 75 30 30.



6. WARRANTY EXCLUSIONS

THE WARRANTY DOES NOT COVER:

- Start-up and setting up of the product.
- Damage resulting from normal wear and tear of the product.
- Damage resulting from improper use of the product.
- Damage resulting from assembly or start-up not in accordance with the user manual.
- Breakdowns related to carburetion beyond 90 days and fouling of carburetors.
- Periodic and standard maintenance events.
- Actions of modification and dismantling that directly void the warranty.
- Products whose original authentication marking (brand, serial number) has been degraded, altered or withdrawn.
- Replacement of consumables.
- The use of non-original parts.
- Breakage of parts following impacts or projections.
- Accessories breakdowns.
- Defects and their consequences linked to any external cause.
- Loss of components and loss due to insufficient screwing.
- Cutting components and any damage related to the loosening of parts.
- Overload or overheating.
- Poor power supply quality: faulty voltage, voltage error, etc.
- Damages resulting from the deprivation of enjoyment of the product during the time necessary for repairs and more generally the costs related to the immobilization of the product.
- The costs of a second opinion established by a third party following an estimate by a SWAP-Europe repair station
- The use of a product which would show a defect or a breakage which was not the subject of an immediate report and/or repair with the services of SWAP-Europe.
- Deterioration linked to transport and storage*.
- Launchers beyond 90 days.
- Oil, petrol, grease.
- Damages related to the use of non-compliant fuels or lubricants.

* In accordance with transport legislation, damage related to transport must be declared to carriers within 48 hours maximum after observation by registered letter with acknowledgement of receipt.

This document is a supplement to your notice, a non-exhaustive list.

Attention: all orders must be checked in the presence of the delivery person. In case of refusal by the delivery person, it you must simply refuse the delivery and notify your refusal.

Reminder: the reserves do not exclude the notification by registered letter with acknowledgement within 72 hours.

Information: Thermal devices must be wintered each season (service available on the SWAP-Europe site). Batteries must be charged before being stored.

HYUNDAI

POWER PRODUCTS

For inquiries, please contact:

BUILDER SAS

32 rue Aristide Bergès - Z.I. du Casque - 31270 Cugnaux - France

Tél.: +33(0)5.34.502.502 Fax.: +33(0)5.34.502.503

<http://www.hyundaipower-fr.com/>

Fabriqué en République Populaire de Chine(PRC)