

**HYUNDAI**  
POWER PRODUCTS

PETROL TILLER

HMTB80

ORIGINAL INSTRUCTIONS

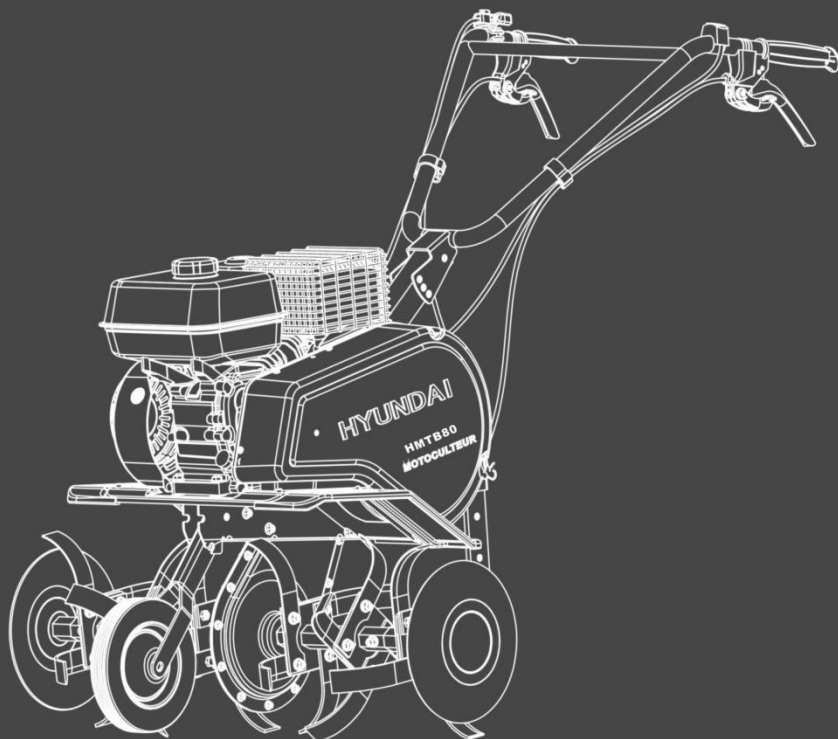

**CAUTION:** Read the instructions carefully. Be familiar with the controls and the proper use of the equipment

## **1. SAFETY WARNING:**

For your safety and safety of others please pay special attention to these precautions:

### **1) Training**

- a) Read the instructions carefully. Be familiar with the controls and the proper use of the equipment;
- b) Never allow children or people unfamiliar with these instructions to use the machine. Local regulations can restrict the age of the operator;
- c) Never work while people, especially children, or pets are nearby;
- d) Keep in mind that the operator or user is responsible for accidents or hazards occurring to other people or their property.

### **2) Preparation**

- a) While working, always wear substantial footwear and long trousers. Do not operate the equipment when barefoot or wearing open sandals;
- b) Thoroughly inspect the area where the equipment is to be used and remove all objects which can be thrown up by the machine;
- c) **WARNING – Petrol is highly flammable:**
  - Store fuel in containers specifically designed for this purpose;
  - Refuel outdoors only and do not smoke while refuelling;
  - Add fuel before starting the engine. Never remove the cap of the fuel tank or add petrol while the engine is running or when the engine is hot;
  - If petrol is spilled, do not attempt to start the engine but move the machine away from the area of spillage and avoid creating any source of ignition until petrol vapours have dissipated;
  - Replace all fuel tank and container caps securely;
- d) Replace faulty silencers;
- e) Before using, always visually inspect to see that the tools are not worn out or damaged. Replace worn out or damaged elements and bolts in sets to preserve balance.

### **3) Operation**

- a) Do not operate the engine in a confined space where dangerous carbon monoxide fumes can collect;

- b) Work only in daylight or in good artificial light;
- c) Always be sure of your footing on slopes;
- d) Walk, never run with the machine;
- e) For wheeled rotary machines, work across the slopes, never up and down;
- f) Exercise extreme caution when changing direction on slopes;
- g) Do not work on excessively steep slopes;
- h) Use extreme caution when reversing or pulling the machine towards you;
- i) Do not change the engine governor settings or overspeed the engine;
- j) Start the engine carefully according to manufacturer instructions and with feet well away from the tool(s);
- k) Do not put your hands or feet near or under rotating parts;
- l) Never pick up or carry a machine while the engine is running;
- m) Stop the engine:
  - Whenever you leave the machine;
  - Before refuelling;
- n) Reduce the throttle setting during engine shut down and, if the engine is provided with a shut-off valve, turn the fuel off at the conclusion of working;

#### **4) *Maintenance and storage***

- a) Keep all nuts, bolts and screws tight to ensure the equipment is in safe working condition;
- b) Never store the equipment with petrol in the tank inside a building where fumes can reach an open flame or spark;
- c) Allow the engine to cool before storing in any enclosure;
- d) To reduce the fire hazard, keep the engine, silencer, battery compartment and petrol storage area free of vegetative material and excessive grease;
- e) Replace worn or damaged parts for safety;
- f) If the fuel tank has to be drained, this shall be done outdoors.

#### **Thrown Object Hazard**

Objects hit by the rotating tines can be thrown from the tiller with great force and may cause severe injury.

- 1) Before tilling, clear the tilling area of sticks, large stones, wire, glass

etc.

- 2) Pieces thrown from worn or damaged-tines can cause serious injury. Always inspect the tines before using the tiller.

### **Fire and Burn Hazard**

Gasoline is extremely flammable and gasoline vapor can explode.

Use extreme care when handling gasoline. Keep gasoline out of reach of children.

- 1) Refuel in a well-ventilated area with the engine stopped.
- 2) Allow the engine to cool before refueling. Fuel vapor or spilled fuel may be ignited.
- 3) The engine and exhaust system becomes very hot during operation and remains hot after stopping. Touching them can cause burn injuries or some materials burn.
- 4) Avoid touching a hot engine or exhaust system.
- 5) Allow the engine to cool before performing maintenance or storing the tiller indoors.













### **Carbon Monoxide Poisoning Hazard**

Exhaust contains poisonous carbon monoxide a colorless and odorless gas. Breathing exhaust can cause loss of consciousness and may lead to death.

### **Operation on Slope**

- 1) When tilling on slopes, keep the fuel tank with less than half oil to minimize fuel spillage.
- 2) When the tiller walks across the slope, put your effort evenly while walking up and down the slope.
- 3) Be very careful when changing the direction of the tiller on a slope.
- 4) Do not use the tiller on a slope of more than 10°.
- 5) The maximum safe grade angle shown is for reference only and the details should depend on the type of the tool. Before starting the engine, check that the tiller is not damaged and in good condition. For your safety or safety of others, pay special attention when using the tiller up or down hill.

## 2. WARNING SYMBOL

		Attention!
		Caution: fire risk!
		The part is extremely hot! Do not touch!
		Read the instruction manual before use
		Caution: Do not put your hands in belt when it running.
		Caution: rotating working tool!
		
		Keep away from the machine.
		Warning: Exhaust emissions are harmful to health of body.
		Add engine oil.

- That the machine shall always be used in accordance with these manufacturer's instructions the instruction handbook
- The engine shall be stopped when carrying out maintenance and cleaning operations, when changing tools and when being transported by means other than under its own power;
- Some hazards can be met when working on slopes; work slowly by holding firmly the tool. Do not transport the tool on slopes. The hazards can rise when working on difficult soil (stony, hard, etc.). there is a risk to hit some objects, sliding, lose control for the machine which will gives damages. Always inspect the working area before working, and always watch what you are doing.
- The adjustable part of the protective device shall be adjusted to the working depth of the tool so that only that part of the working tool that cuts into the soil remains uncovered. This does not apply to motor hoes.
- The machine should only be operated by suitably trained persons.
- During the operation of the machine safety shoes should be worn.
- Always start up the machine under normal conditions.

#### Intended use

This device is to be used only as an electric hoe for aerating lawns and grassy areas in private home gardens and pleasure gardens. It is not intended for use in public spaces, parks, sports fields, agriculture or forestry. Use of this device for any other purpose is considered incorrect and unapproved. The manufacturer will not be responsible for any damage or injury resulting from such use. The user is fully responsible for all related risks.

### 3. STRUCTURAL REPRESENTATION



- |                   |                  |
|-------------------|------------------|
| 1. Engine Switch  | 9. Gearbox Assy  |
| 2. Clutch Handle  | 10. Fender       |
| 3. Handle Bar     | 11. Engine       |
| 4. Reverse handle | 12. Silencer     |
| 5. Throttle lever | 13. Air filter   |
| 6. Belt Cove      | 14. Recoil start |
| 7. Walking Wheel  |                  |
| 8. Blade          |                  |

#### 4. ASSEMBLY

The machine is packed in a box of the following dimensions :

LENGTH: 69CM	WIDTH: 38CM	HEIGHT: 77CM
--------------	-------------	--------------

The engine fitted on this cultivator have following features:

Exhaust guard

Recoil starter

Dry air filter

ENGINE LUBRICATION WITH: see instruction manual of the engine.

Quantity of engine oil: see instruction manual of the engine.

Fuel: unleaded petrol

Safety device for forward gear stopping the tiller.

The model HMBT80 has a front belt transmission for the engine and a greased chain for the tiller.

The handlebar can be:

1. adjustable in 1 vertical positions
2. adjustable in different positions (height and side)

The gear-box is screwed(Pitc.1).



(Pitc.1)

The Resistance plough can be adjustable (Pitc.2).





(Pitc.2)

All the identification references (code number, engine, weight, power) are printed on the number plate on the machine (Pitc.3).



(Pitc.3)

- 1) Take the machine out of the carton box.
- 2) Fit the two tillers to the main shaft using the delivered screws and nuts.
- 3) Fit the rear spur in its place using the delivered bolt and both pins which are on the spur holder.
- 4) Fit the handlebar on the support:
  - a. The model with the vertical adjustment is fitted with two screws and nuts already fitted on the handlebar.
  - b. The model with the full-side adjustment (rack, wheel system) is fitted with the parts already mounted on the handlebar holder.
- 5) The front wheel fixed by bolt (M12\*80) ,Nut M12. And pull front wheel till B type axis pin fixed when you do not use front wheelThe wheels can be adjusted up and

down(see Pict.4).

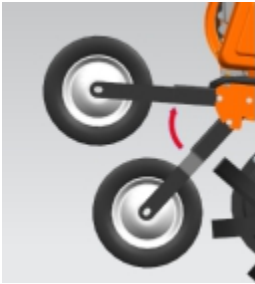

(Pict.4)

- 6) Fit the two guard-extensions to the main tiller protections fitted on the body of the machine using the proper screws and nuts. The fender should reach a width of 60 cm according to CE norms.
- 7) To make the transport easier it is possible to keep the handlebar disassembled, by means of the two screws in one version or by means of the thread bushing in the other one, that fix it to the handlebar holder.

## 5. STARTING AND STOPPING

Starting the engine of the machine always follow these instructions very carefully:

Check the oil in the engine:

THE BRAND NEW MACHINE IS DELIVERED WITHOUT OIL IN THE ENGINE, THEREFORE YOU SHOULD FILL IT UP TO THE LEVEL ON THE DIP STICK OF THE OIL CUP.

Please check the engine USE AND MAINTENANCE concerning the “operations before starting”.

Start the engine only in open spaces.

1. Pull the choke lever on the engine(where present is).
2. Turn the accelerator lever to the “FAST” position (Pict.6). Turn the engine switch to the ON position (Pict.5).
3. The clutch lever should be released (Pict.8 and Pict.9).
4. Pull the starting rope by the handle smoothly first than strongly: when you feel some resistance don't leave the handle but help the recoiling of the rope with your hand (Pict.10).

5. When the engine runs move the choke lever to the initial position and the accelerator lever in the mid-position.

6. For stopping the engine move the accelerator lever in "LOW" position (Pict.5). Turn the engine switch to OFF position (Pict.7).



Pict.5



Pict.6



Pict.7



Pict.8



Pict.9



Pict.10

## 6. USE AND ADJUSTMENT

6.1 Release clutch handle bar (pict8), Tiller stop.

6.2 When machine need reverse, Grasp reverse handle bar(pict9).

6.3 Model NO. HMBT80,Distance between belt is  $52\pm 5$  mm.

Please note only take off screw from front supportor , and belt cover, then you can check the belt distance,(see photo below).



if clutch is not working properly, The best way is adjust clutch cable nut to proper position as photo below:



Clutch  
cable nut

Grasp clutch handle bar, and loosen handle bar, the tension distance is 10mm, if you can not adjust distance to 10mm by nut, then please try following method:

1,Take off bolt from engine supportor, and adjust position that you need.

The standard tiller is 55 cm wide(Pict.15), with two sets of knives on each side. Adding other two sets of blades you can extend the tiller to 80 cm (Pict.15). The blades of the tiller-knives should always be directed ahead, towards the front of the machine

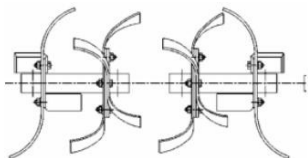

550mm

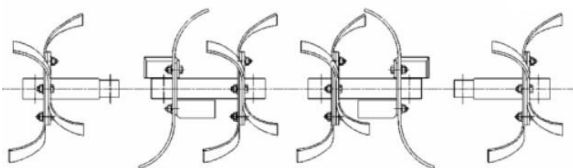

800mm

Pitc.15

## 7. Technical Parameter

Model	HMTB80
Engine type	H170F
Rated engine power	4.0kW
Engine rated speed	3600/min
Displacement	212cm <sup>3</sup>
Tilling Width	800mm
Tilling Depth	≥100mm
Working speed	170min

Gear Shifts:	-1, 0, +1 (One forward gears, one neutral gear and one reverse gear)
Blade Type	3-4(6 sets 24Pcs)
Tyre Model	8×1.75
Carton dimensions	590mm×380mm× 750mm
Net weight	57kg
Gross weight	59kg
Sound pressure level measured	Left: 78,5 dB(A) Right:79dB(A)
Sound power level measured	94,1 dB(A)
Guaranteed noise level	98dB(A)
Vibration level	Left: 6,14m/s <sup>2</sup> Right: 5,48 m/s <sup>2</sup> K=1,5m/s <sup>2</sup>

## 8. MAINTENANCE

Please note that maintenance operations are scheduled for normal operating conditions. If the operation of tiller takes place under other conditions, we recommend that you communicate with your dealer to deal with the machine.

1. Turn off the engine and disconnect the spark plug prior to maintenance operations.
2. Allow the engine and exhaust system to cool to avoid burns from contacting with hot parts.
3. It is important to keep safety gloves in the event that you need to manipulate the blades.
4. Wipe the dirt things on the machine.
5. Remove the fuel from tiller if this is to be stored for longer than a month.
6. It is appropriate to check that all bolts and nuts have not been loosened after each session.
7. The guard should be fixed after assembling and it should not be removed or adjusted during use and maintenance

For the normal maintenance (oil, filter, spark plug) check the booklet for the engine included.

The chain for the final transmission is lubricated with normal grease.



Every year you should introduce some grease through the hole “Q” (Pict.14) in the main body.

Keep the machine and the tillers clean and check that all the screws and nuts are well tied, especially the screws of the tiller (always wear protection gloves working on the tiller).

In case of breaking or wearing you can replace the belt after taking off the side protection cover fixed to the frame near the engine shaft by two screws.

Remove the belt from the pulleys, install the new belt end adjust it

following the instructions mentioned in the chapter USE AND ADJUSTMENT by checking the distance between both sides of the belt, then replace the cover.

The pin fixing the big pulley has also a safety purpose: in case heavy obstacle it will break avoiding damages to other parts of the machine.

The replacement of the pin is very easy: you have to insert the new pin in the hole using a hammer.

For any technical repair especially during the guarantee period, it is recommendable to apply to the specialized workshops of our dealers.

#### CAUTION:

It is advised not to keep the motor running when the machine is not being used for its specific purpose.



## 9. BREAKDOWN LIST

### A. Gasoline engine

#### (1) Hard to start machine or fail to start

Breakdown phenomenon		Cause	Solution
no spark at plug	spark plug	carbon deposition of spark plug	clear away carbon
		excessive or too small clearance of spark plug	adjust clearance to 0.7~0.8mm
		Insulation damage of spark plug	replace spark plug
	Others	breakdown of ignitor	replace ignitor
		weak magnetic force of flywheel	replace flywheel
Sparking at plug	good compression	suck excessive fuel into cylinder	take off spark plug and dry it and put it on
		poor quality of fuel with water and dirt	replace fuel
	Loosen oil drain screw at the bottom of Carburetor .No oil shedding.	needle valve block	Clean or replace carburetor
	normal oil supply but poor compression	piston ring abrasion, loose spark plug	replace
		Air leak of cylinder head	screw tight
		wrong air valve clearance or timing	clean, readjust and reassemble
	normal ignition and oil supply	poor contact of high voltage cable and spark plug	replace and connect
		Failure of stop switch , short circuit	clean
		breakdown of oil alert	replace

## (2) Abnormal conditions in the movement

Breakdown phenomenon	Cause	Solution
Insufficient power, Low rotation	damper closed, poor ventilation of muffler	open damper, replace muffler
	moving parts abrasion	check, replace
	speed adjustment mechanism failed to reach the best equilibrium	adjust speed adjustment mechanism
	low ignition power	replace ignitor or flywheel
	excessive clearance of air valve	regulate to the required scope
	carbon deposition	Clear away carbon
excessive fluctuation of speed	speed adjustment mechanism failed to reach the most optimized combination	adjust speed adjustment mechanism
	wrong carburetor	replace carburetor
	wrong space of spark plug	adjust clearance
excessively high speed of rotation	speed adjusting handle failed to press adjust cap tightly or Speed adjust cap lost	Readjustor install speed adjustment cap
abnormal sound	wrong clearance of air valve	adjust clearance of air valve
	cam gear injured	replace camshaft
oil leaking of carburetor	needle valve and oil dirt attached	lightly tap carburetor or clean it.
	O-ring deformation	replace

## B. Tiller

Abnormalities	Common Causes	Measures to be taken
Strange noises	Stuck blade	Turn off the tiller until the engine is completely stopped.
	Leakage of lubricating oil	Fix it in the repair shop
	Loose bolts, nuts and other components	Tighten all the components, if strange noises remain, please contact repair shop
Strong vibration	Damage or wear of the blade	Change blade or fix it in repair shop
	Excessive tillage depth	Adjust the tillage depth
Poor tillage effect	Shallow tillage	Adjust the tillage depth
	Blunt or worn blade	Change blade or fix it in repair shop

## 10. CE Declaration of conformity



CE Declaration of conformity

BUILDER

ZI, 32 rue aristide Bergès – 31270 Cugnaux - France

Declares that the machinery designated below:

PETROL TILLER

HMTB80

Serial number :

[20210543576-20210543827](#)

Complies with the provisions of the Directive "machinery" 2006/42 / EC and  
the national regulations transposing it;

Also complies with the following European directives:

Emission Directive (EU) 2016/1628 and 2018/989/EU

Directive EMC 2014/30 /EU

Also complies with European standards, national standards and technical  
provisions following

EN 709:1997+A4; EN ISO 14982:2009

Done at Cugnaux, le 13/04/2021

A handwritten signature in black ink, appearing to read 'Philippe MARIE'.

Philippe MARIE / PDG

# 11. WARRANTY

# HYUNDAI

## WARRANTY

The manufacturer guarantees the product against defects in material and workmanship for a period of 2 years from the date of the original purchase. The warranty only applies if the product is for household use. The warranty does not cover breakdowns due to normal wear and tear.

The manufacturer agrees to replace parts identified as defective by the designated distributor. The manufacturer does not accept responsibility for the replacement of the machine, in whole or in part, and/or ensuing damage.

### The warranty does not cover breakdowns due to:

- insufficient maintenance.
- abnormal assembly, adjustment or operations of the product.
- parts subject to normal wear and tear.

### The warranty does not extend to:

- shipping and packaging costs.
- using the tool for a purpose other than that for which it was designed.
- the use and maintenance of the machine done in a manner not described in the user manual.

Due to our policy of continuous product improvement, we reserve the right to alter or change specifications without notice. Consequently, the product may be different from the information contained therein, but a modification will be undertaken without notice if it is recognized as an improvement of the preceding characteristic.

### READ THE MANUAL CAREFULLY BEFORE USING THE MACHINE.

When ordering spare parts, please indicate the part number or code, you can find this in the spare parts list in this manual. Keep the purchase receipt; without it, the warranty is invalid. To help you with your product, we invite you to contact us by phone or via our website:

- **+33 (0)9.70.75.30.30**
- **<https://services.swap-europe.com/contact>**

You must create a "ticket" via the web platform.

- Register or create your account.
- Indicate the reference of the tool.
- Choose the subject of your request.
- Describe your problem.
- Attach these files: invoice or sales receipt, photo of the identification plate (serial number), photo of the part you need (for example: pins on the transformer plug which are broken).



# 12. PRODUCT FAILURE

## WHAT TO DO IF MY MACHINE BREAKS DOWN?

### If you bought your product in a store:

- a) Empty the fuel tank if your product has one.
- b) Make sure that your machine is complete with all accessories supplied, and clean! If this is not the case, the repairer will refuse the machine.

Go to the store with the complete machine and with the receipt or invoice.

### If you bought your product on a website:

- a) Empty the fuel tank if your product has one..
- b) Make sure that your machine is complete with all accessories supplied, and clean! If this is not the case, the repairer will refuse the machine.
- c) Create a SWAP-Europe service ticket on the site: <https://services.swap-europe.com> When making the request on SWAP-Europe, you must attach the invoice and the photo of the nameplate (serial number).
- d) Contact the repair station to make sure it is available before dropping off the machine.

Go to the repair station with the complete machine packed, accompanied by the purchase invoice and the station support sheet downloadable after the service request is completed on the SWAP-Europe site

For machines with engine failure from manufacturers BRIGGS & STRATTON, HONDA and RATO, please refer to the following instructions.

Repairs will be done by approved engine manufacturers of these manufacturers, see their site:

- <http://www.briggsandstratton.com/eu/fr>
- <http://www.honda-engines-eu.com/fr/service-network-page;jsessionid=5EE8456CF39CD572AA2AEEDFD290CDAE>
- <https://www.rato-europe.com/it/service-network>

**Please keep your original packaging to allow for after-sales service returns or pack your machine with a similar cardboard box of the same dimensions.**

**For any question concerning our after-sales service you can make a request on our website <https://services.swap-europe.com>**

**Our hotline remains available at +33 (9) 70 75 30 30.**



# 13. WARRANTY EXCLUSIONS

## THE WARRANTY DOES NOT COVER:

- Start-up and setting up of the product.
- Damage resulting from normal wear and tear of the product.
- Damage resulting from improper use of the product.
- Damage resulting from assembly or start-up not in accordance with the user manual.
- Breakdowns related to carburetion beyond 90 days and fouling of carburetors.
- Periodic and standard maintenance events.
- Actions of modification and dismantling that directly void the warranty.
- Products whose original authentication marking (brand, serial number) has been degraded, altered or withdrawn.
- Replacement of consumables.
- The use of non-original parts.
- Breakage of parts following impacts or projections.
- Accessories breakdowns.
- Defects and their consequences linked to any external cause.
- Loss of components and loss due to insufficient screwing.
- Cutting components and any damage related to the loosening of parts.
- Overload or overheating.
- Poor power supply quality: faulty voltage, voltage error, etc.
- Damages resulting from the deprivation of enjoyment of the product during the time necessary for repairs and more generally the costs related to the immobilization of the product.
- The costs of a second opinion established by a third party following an estimate by a SWAP-Europe repair station
- The use of a product which would show a defect or a breakage which was not the subject of an immediate report and/or repair with the services of SWAP-Europe.
- Deterioration linked to transport and storage\*.
- Launchers beyond 90 days.
- Oil, petrol, grease.
- Damages related to the use of non-compliant fuels or lubricants.

\* In accordance with transport legislation, damage related to transport must be declared to carriers within 48 hours maximum after observation by registered letter with acknowledgement of receipt.

This document is a supplement to your notice, a non-exhaustive list.

**Attention:** all orders must be checked in the presence of the delivery person. In case of refusal by the delivery person, it you must simply refuse the delivery and notify your refusal.

**Reminder:** the reserves do not exclude the notification by registered letter with acknowledgement within 72 hours.

### Information:

Thermal devices must be wintered each season (service available on the SWAP-Europe site). Batteries must be charged before being stored.

**HYUNDAI**  
POWER PRODUCTS

**For Inquiries, please contact:**

BUILDER SAS

32, rue Aristide Bergès Z1 31270 Cugnaux, France

Tél. : +33 (0) 5.34.502.502 Fax : +33 (0) 5.34.502.503

<http://www.hyundaipower-fr.com/>

Fabriqué en République Populaire de Chine (PRC)