

HYUNDAI
POWER PRODUCTS

**PETROL MUTIL-TOOL
HCOMBI60-A**

ORIGINAL INSTRUCTIONS

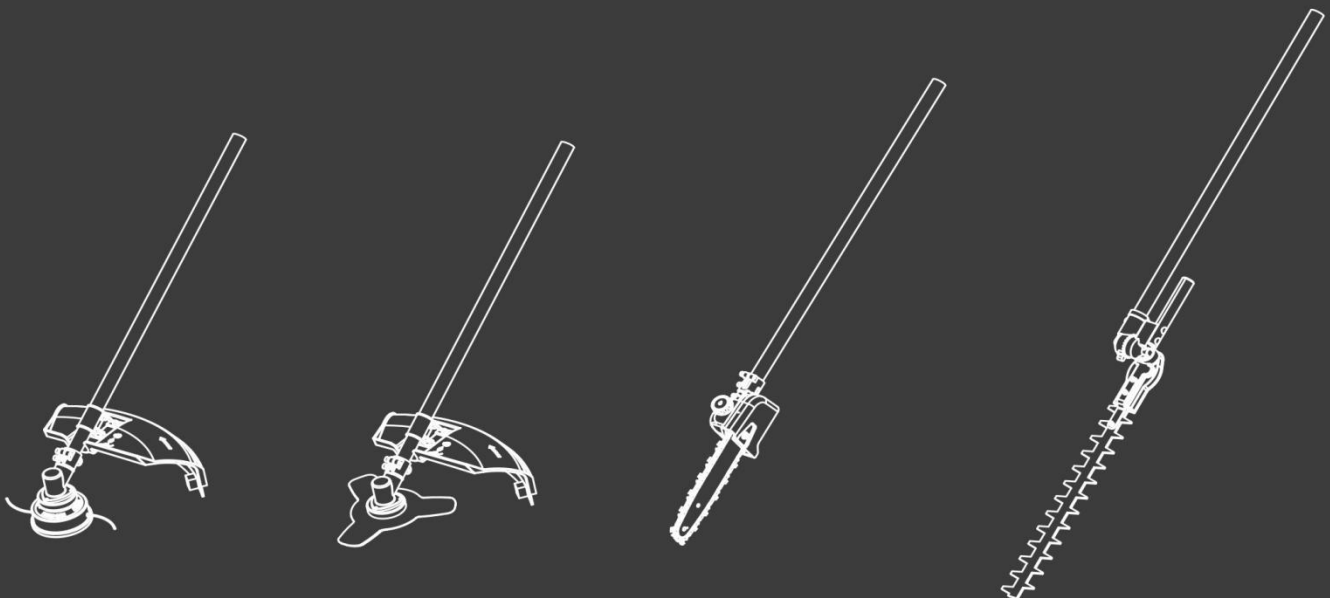
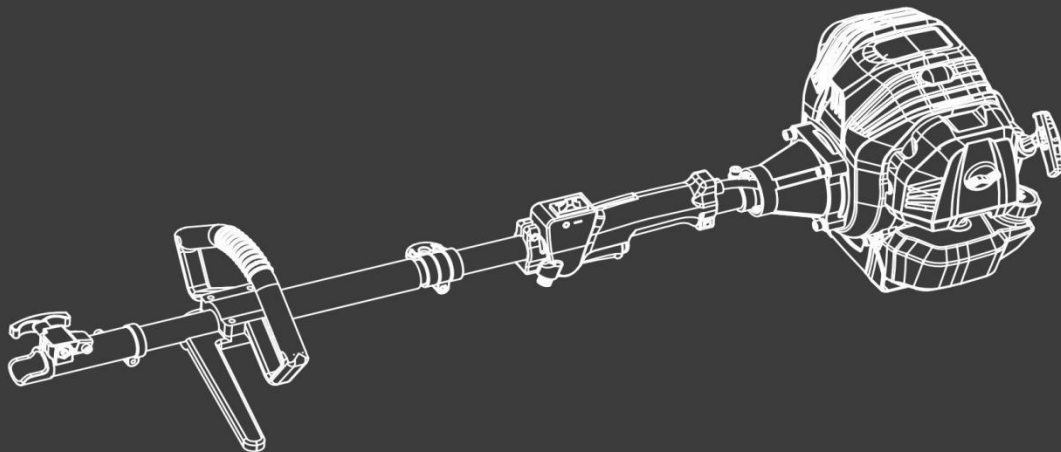

WARNING: Read thoroughly the instruction manual before use.

1. SAFETY INSTRUCTIONS

Safety instructions for brushcutter and grass trimmer

Proper safety precautions must be observed. This unit must be handled carefully. DO NOT EXPOSE YOURSELF OR OTHERS TO DANGER.

Follow these general rules. Do not permit others to use this machine unless they are thoroughly responsible and have read, and understand the machine manual and are trained in its operation.

- Always wear safety goggles for eye protection. Dress properly; do not wear loose clothing or jewellery that could become caught in moving parts of the unit. Safe, sturdy, non-skid footwear should always be worn. Long hair should be tied back. It is recommended that legs and feet be covered to protect from flying debris during operation.
- Protective equipment must always be wear during the operation of the tool, including at least hearing protection, eyes protection, helmet, gloves, and mask of protection, slip-resistant foot protection, and protective clothes.
- Inspect the entire machine for loose parts (nuts, bolts, screws, etc.) and any damage. Repair or replace as necessary before using the machine. DO NOT USE any attachment other than the ones recommended by our company. Serious injury to the operator or bystanders could result as well as damage to the machine. Ask advice to you dealer of manufacturer. Do not use cutting attachment such as metal multi-piece pivoting chains and flail blades.
- Secure the machine during transport to prevent loss of fuel, damage or injury; always install the protection device on the blade, check the cap of the fuel tank, and do not transport the tool upside down.
- Keep the handles free from oil and fuel.
- Always use proper handles and shoulder strap when cutting.
- Do not smoke while mixing fuel or filling tank.
- Do not mix fuel in an enclosed room or near open flames. Assure adequate ventilation.
- Always mix and store the fuel in a properly marked container that is approved by local codes and ordinances for such usage.
- Never remove the fuel tank cap while the engine is running.
- Never start or run the engage inside a closed room or building. Fumes from the exhaust contain dangerous carbon monoxide.
- Never attempt to make engine adjustments while the unit is running and strapped to the operator. Always make engine adjustments with the unit resting on a flat, clear surface.
- Do not use the unit if it is damaged or poorly adjusted. Never remove the machine's guard. Serious injury to the operator or bystanders could result as well as damage to the machine.
- Inspect the area to be cut and remove all debris that could become entangled in the nylon cutting head. Also remove any objects that the unit may throw during cutting.
- Keep children away. Onlookers should be kept at a safe distance from the work area, at least 15 meters.
- Never leave the machine unattended.
- Do not use this unit for any job other than those for which it is intended as described in this manual.
- Do not overreach. Keep proper footing and balance at all times. Do not run the unit while standing on a ladder or on any other unstable footing location.
- Keep hands and feet clear of the nylon cutting head or blade while unit is in use.

- Do not use this type of machine for sweeping away debris.
- Do not use the unit when you are tired, ill or under the influence of medication, drugs or alcohol.
- Use nylon cutting head which is free of damage. If a stone or any other obstacle is hit, stop the engine and check the nylon cutting head. A broken or unbalanced nylon cutting head must never be used.
- Do not store in a closed area where fuel vapors can reach an open flame from hot water heaters, furnaces, etc. Store in a locked, well-ventilated area only.
- Ensure safe and proper performance of your product. These parts are available from your dealer. The use of any other accessories or attachments may cause a potential hazard or injury to the user, damage to the machine and void this warranty.
- Clean the machine completely, especially, the fuel tank, its surroundings, and the air cleaner.
- When refueling, be sure to stop the engine and confirm that it is cooled down. Never refuel when the engine is running or hot. When gasoline spills, be sure to wipe it up completely dispose of those materials before starting the engine.
- Stay clear of other workers or bystanders by at least 15 meters.
- Whenever approaching an operator of the machine, carefully call his attention and confirm that the operator stop the engine. Be careful not to startle or distract the operator which can cause an unsafe situation.
- Never touch the nylon cutting head or blade whenever the engine is running. If it is necessary to replace the protector or cutting attachment, be sure to stop the engine and confirm that the cutting device has stopped running.
- The engine should be turned off when the machine is moved between work areas.
- Be careful not to hit the nylon cutting head against stones, or the ground.
- Unreasonable rough operation will shorten the life of the machine as well as create an unsafe environment for yourself and those around you.
- Pay attention to loosening and overheating of parts. If there is any abnormality of the machine, stop operation immediately and check the machine carefully. If necessary, have the machine serviced by an authorized dealer. Never continue to operate a machine which may be malfunctioning.
- In start-up or during operation of the engine, never touch hot parts such as the muffler, the high voltage wire or the spark plug.
- After the engine has stopped, the muffler is still hot. Never place the machine in any places where there are flammable materials (dry grass, etc.), combustible gasses or combustible liquids.
- Pay special attention to operation in the rain or just after the rain as the ground may be slippery.
- If you slip or fall to the ground or into a hole, release the throttle lever immediately.
- Be careful not to drop the machine or hit it against obstacles.
- Before proceeding to adjust or repair the machine, be sure to stop the engine and detach the spark plug.
- When the machine is placed in storage for a long time, drain fuel from the fuel tank and carburettor, clean the parts, move the machine to a safe place and confirm that the engine is cooled down.
- Make periodic inspections to assure safe and efficient operation. For a thorough inspection of your machine, please contact a dealer.
- Keep the machine away from fire or sparks.
- It is believed that a condition called Raynaud's phenomenon, which affects the fingers of certain individuals, may be brought about by exposure to vibration and cold. Loss of colour and numbness in the fingers. The following precautions are strongly recommended because the minimum exposure which

might trigger the ailment is unknown.

- Keep your body warm, especially the head, neck, feet, ankles, hands and wrists.
- Maintain good blood circulation by performing vigorous arm exercises during frequent work breaks and also by not smoking.
- Limit the hours of operation. Try to fill each day with jobs where operating the brush cutter or other hand-held power equipment is not required.
- If you experience discomfort, redness and swelling of the fingers followed by whitening and loss of feeling, consult your physician before further exposing yourself to cold and vibration.
- Always wear ear protection, loud noise for long time can make hearing debase even lost hearing.
- Total face and head protection must be wearing to prevent damage from plummet or branch.
- Wear no-slip heavy duty work gloves to improve your grip on the brush cutter handle. Gloves also reduce the transmission of machine vibration to your hands.
- **WARNING:** The cutter area is still dangerous while the machine is coasting to a stop.
- When transport, this unit must be handled carefully. Do not expose yourself or others to danger.
- Envelop the blade before storage. Keep children away from it.
- Never remove the machine's guard.
- Clean and maintain the tool before storage (see the chapters on this manual). Bring maintenance after each use according the instructions of this manual. Improper maintenance can reduce the lie of the tool, bring bad results and wear the tool and its accessories.
- Check the tool before and after use. Check for loose fasteners, fuel leaks and damaged parts, such as cracks in the cutting attachment. If the tool is damaged, if parts are missed or meet some dysfunctions, do not use the tool and bring it to a service agent for inspection and reparation.
- Check the tool after dropping or other impacts to identify any significant defects; if any defects are observed, stop to use the tool and bring it to a service agent for inspection and reparation.
- Do not store in a closed area where fuel vapours can reach an open flame from hot water heaters, furnaces, etc. Store in a locked, well-ventilated area only.
- Never place the machine in any places where there are flammable materials (dry grass, etc.), combustible gasses or combustible liquids.
- When the machine is placed in storage for a long time, drain fuel from the fuel tank and carburettor, clean the parts, move the machine to a safe place and confirm that the engine is cooled down.
- Emission of exhaust gases
- National regulation can restrict the use of the machine.
- Never modify a trimmer or cutter in any way.
- Improper use of the machine can cause **SERIOUS OR FATAL PERSONAL INJURY**.
- The engine exhaust form this product contains chemicals to cause cancer, birth defects, of other reproductive harm.
- Check regularly that the cutting attachment stops turning when the engine idles.

Kickback and Related Warnings

- Kickback is a sudden reaction to a pinched or snagged rotating wheel, backing pad, brush or any other accessory. Pinching or snagging causes rapid stalling of the rotating accessory which in turn causes the uncontrolled power tool to be forced in the direction opposite of the accessory's rotation at the point of the binding.
- For example, if an abrasive wheel is snagged or pinched by the workpiece, the edge of the wheel that is

entering into the pinch point can dig into the surface of the material causing the wheel to climb out or kick out. The wheel may either jump toward or away from the operator, depending on direction of the wheel's movement at the point of pinching. Abrasive wheels may also break under these conditions.

- Kickback is the result of power tool misuse and/or incorrect operating procedures or conditions and can be avoided by taking proper precautions as given below:
 - o Never place your hand near the rotating accessory. Accessory may kickback over your hand.
 - o Do not position your body in the area where power tool will move if kickback occurs. Kickback will propel the tool in direction opposite to the wheel's movement at the point of snagging.
 - o Use special care when working corners, sharp edges etc. Avoid bouncing and snagging the accessory. Corners, sharp edges or bouncing have a tendency to snag the rotating accessory and cause loss of control or kickback.

Residual risks

Even if you use this tool correctly, there are always residual risks. The following hazards may arise in connection with the structure and manufacture of this power tool:

- Hearing impairment if no suitable hearing protection is worn.
- Cuts if no suitable protective clothing is worn.
- Health damage resulting from vibration in the hands and arms if the device is used for a long period of time or is not handled and maintained properly.
- Inhalation of particles
- Inhalation of exhaust gases
- Skin contact with oil / gasoline
- Inhalation of gasoline / oil vapors
- Contact with projected objects
- Burns when touching with hot surfaces
- Prolonged use of this product exposes the operator to vibration and can produce so-called "white finger" disease. To reduce the risk, wear gloves and keep your hands warm.
- If any of the symptoms of "white finger syndrome" occur, seek immediate medical attention. Symptoms of the "white finger" include numbness, loss of sensitivity, tingling, pain, loss of strength, color changes or skin condition. These symptoms usually appear on the fingers, hands or wrists. Risk increases at low temperatures.

Safety instructions for the hedge trimmer

WARNING! Before using this tool, please read these instructions of safety and use. It will help you to use safely the machine and reduce the risk of electrical shocks and accidents. If you give this tool to another person, also give this manual.

Use this tool as described in this manual. Any mishandling and any use contrary to instructions will not in any way engage the liability of the manufacturer.

Non-compliance with safety instructions and use can cause a risk of electric shock, fire and / or injury to persons.

IMPORTANT
Read carefully before use
Keep for future reference

Safe operating practices

Training

Become familiar with the owner's manual before attempting to operate the equipment.

Preparation

- a) THIS HEDGE TRIMMER CAN CAUSE SERIOUS INJURIES. Read the instructions carefully for the correct handling, preparation, maintenance, starting and stopping of the hedge trimmer. Become familiar with all controls and the proper use of the hedge trimmer.
- b) Never allow children to use the hedge trimmer.
- c) Beware of overhead power lines.
- d) Avoid operating while people, especially children, are nearby.
- e) Dress properly! Do not wear loose clothing or jewellery, which can be caught in moving parts. Use of sturdy gloves, non-skid footwear and safety glasses is recommended.
- f) Use extra care when handling fuels. They are flammable and the vapours are explosive. The following points should be observed:
 - Use only an approved container.
 - Never remove the fuel cap or add fuel with the power source running. Allow engine and exhaust components to cool down before refuelling.
 - Do not smoke.
 - Never refuel indoors.
 - Never store the hedge trimmer or fuel container inside where there is an open flame, such as near a water heater.
 - If fuel is spilled, do not attempt to start the power source, but move the hedge trimmer away from the spillage before starting.
 - Always replace and securely tighten the fuel cap after refuelling.
 - If the fuel tank is drained, this should be done outdoors.
- g) If the cutting mechanism strikes any foreign object or the hedge trimmer starts making any unusual noise or vibration, shut off the power source and allow the hedge trimmer to stop. Disconnect the spark plug and take the following steps:
 - inspect for damage;
 - check for, and tighten, any loose parts;
 - have any damaged parts replaced or repaired with parts having equivalent specifications
- h) Wear ear protection.
- i) Wear eye protection.
- j) In case of emergency, stop the hedge trimmer; release the trigger, switch off the tool with the ON/OFF button. Let it completely stop and be cool before any intervention.

Operation

Use the tool for the intended purpose and follow these provided instructions for use and maintenance

- a) Stop the engine before:
 - cleaning or when clearing a blockage,
 - checking, carrying out maintenance or working on the hedge trimmer,
 - adjusting the working position of the cutting device,
 - Leaving the hedge trimmer unattended.
- b) Ensure that the hedge trimmer is correctly located in a designated working position before starting the engine.
- c) While operating the hedge trimmer, always ensure that the operating position is safe and secure, especially when using steps or a ladder.
- d) Do not operate the hedge trimmer with a damaged or excessively worn cutting device.
- e) To reduce fire hazards, keep the engine and silencer free of debris, leaves and excessive lubricant.
- f) Always ensure that all handles and guards are fitted when using the hedge trimmer. Never attempt to use an incomplete hedge trimmer or one fitted with an unauthorized modification.

- g) Always use two hands to operate a hedge trimmer fitted with two handles.

Maintenance and storage

- a) When the hedge trimmer is stopped for servicing, inspection or storage, shut off the power source, disconnect the spark plug wire from the spark plug and make sure all moving parts have come to a stop. Allow the hedge trimmer to cool before making any inspections, adjustments, etc.
- b) Store the hedge trimmer where the fuel vapour will not reach an open flame or spark. Always allow the hedge trimmer to cool down before storing.
- c) When transporting or storing the hedge trimmer, always fit the cutting device transport guard.

Additional instructions

- Never allow children to use the hedge trimmer.
- Work only during in the day or with a sufficient artificial light.
- Before starting to work, check the condition of the tool.
- Ensure that all the parts of the machine are well fixed and tightened.
- Control regularly that the blade of cut is in good state.
- Always hold firmly the hedge trimmer with the two hands.
- Never take or hold the hedge trimmer by the blade.
- Maintain clothing out of reach blade as well with the stop as under operation.
- Keep the device distant from all shapes of sparks, flames and flammable materials.
- Control that the working areas are free from all shapes of obstacles.
- Work with precaution, be not distracted.
- Do not use the tool when you are under the influence of alcohol, meds or drugs, and where you are sick.
- Dry all possible gasoline traces by using a dry rag.
- In case of accident, immediately stop using the machine. Check the problem. Do not use the machine while the machine is damaged.
- Operate the machine only at reasonable hours – not early in the morning or late at night when people might be disturbed;
- When blockage occurs, immediately turn off the engine with the ON/OFF button. Let the tool cool down. Check and correct the blockage before starting again to work. Use gloves when clearing a blockage. Restart the machine securely when the machine is totally unblocked.
- When a danger or a non-intended situation arise, stop to work immediately and switch off the tool. Restart to work when there is no danger and you are able to work safely.
- Cut before the large branches with a hand shears to avoid the blocking of the blade.
- Pay attention not to cut iron wire or others.
- Do not use non-recommended accessories with this tool. To replace any piece of this tool, please contact the retailer, service agent or manufacturer.
- Use only the mixture recommended by the manufacturer.
- Store the mixture in a specific container for the gasoline.
- Keep the device in a quite dry place and out of reach of children.
- Store the mixture only on free air or in a well-ventilated place. Handle the fuel with precaution, it is highly flammable.
- Do not smoke or use telephone when you handle gasoline.
- Use a funnel and fill the tank only when the engine is cold.
- Do not open the tank if the engine is hot or under operation.
- Keep [people and yourself far away from the exhaust to avoid the risks of burns.
- Maintain the people and the animals far away from the working area.
- Always remind that this machine can cause very serious incidents.
- Do not work under the rain and/or in places wet and/or slipping.
- Do not expose to the rain.
- Do not use the tool during bad weather conditions and where a risk of lighting is possible.
- Use complete personal protective equipment during the use of the tool: gloves, antiskid footwear, helmet, eyes protection, protection clothes, and mask of protection.

- Do not use the machine when you are tired, under the influence of alcohol or drugs or sick.
- The machinery must not be used in a way where experience has shown that danger and/or risks might occur.
- Never use hedge trimmer inside a building. Your hedge trimmer produces toxic exhaust fumes as soon as the engine is started. The use of this product can generate dust, vapours and smoke containing chemicals known for their harmful effects on health. So be careful during the use of your machine and protect yourself correctly. Also avoid voluntarily breathing exhaust fumes; always hold the machine correctly when you use it.

Residual risks

Even if you use this product in compliance with all safety requirements, the potential risks of injury and damage remain. The following hazards may arise in the structure and design of this product. Always be vigilant when using this product, so you can recognize and manage the risks rather. Rapid intervention can prevent serious injury and property damage.

- There are harmful health consequences resulting from the emission of vibrations if the product is used for long periods of time or not properly managed and properly maintained.
- There is risk of injury and property damage due to attachments or broken the sudden impact of hidden objects.
- Risk of injury to persons and property caused by flying objects.
- Prolonged use of this product exposes the operator to vibration and can produce so-called “white finger” disease. To reduce the risk, wear gloves and keep your hands warm. If any of the symptoms of “white finger syndrome” occur, seek immediate medical attention. Symptoms of the “white finger” include numbness, loss of sensitivity, tingling, tingling, and pain, loss of strength, color changes or skin condition. These symptoms usually appear on the fingers, hands or wrists. Risk increases at low temperatures
- Inhalation of particles
- Inhalation of exhaust gases
- Unattended projections
- Contact with foreign objects
- Contact with the tool in operation
- Hearing loss in the absence of correct hearing protection

Safety warnings for the mounted pole pruner

- Secure the machine during transport to prevent loss of fuel, damage or injury; always install the protection device on the blade, check the cap of the fuel tank, and do not transport the tool upside down.
- Always bring cleaning and maintenance before the storage of the tool. Follow the instructions given in this manual. Improper maintenance will increase of accidents, kickback of the blade and bad working results.
- Use the transport guard on the blade during transport and storage.
- Checking that the cutting attachment stops turning when the engine idles.
- Check the tool before and after use. Check for loose fasteners, fuel leaks and damaged parts, such as cracks in the saw blade. If the tool is damaged, if parts are missed or meet some dysfunctions, do not use the tool and bring it to a service agent for inspection and repairation.
- Follow the instructions of the manual for guide-bar and chain adjustments. This shall be done with the engine stopped.
- National regulation can restrict the use of the machine.
- Always inspect the pruner before use and after dropping or other impacts in order to identify any significant damage or defects.
- Danger – Do not use the machine near overhead electric power lines.
- Warning – Do not the use of the machine when tired, ill or under the influence of alcohol or other drugs.
- Always be sure to maintain a steady, even posture while working. It is necessary to have rest periods and change working positions.

- Warning - Risk of danger for bystanders; they must be kept at a safe distance from the machine during its operation.
- Remove branches in sections.
- Warning - Avoid dangerous operating positions;
- There is a risk of being struck by falling branches or branches that, having hit the ground, rebound.
- Warning - there is a danger about the emission of exhaust gases. Do not inhale them do not be exposed to them.
- Keep firm footing and balance during operation. Use the harness provided.
- Do not use the tool if the switch is defective. In the event of a malfunction, do not use the tool and take it to a qualified service for repairs.
- Stop the tool before making adjustments, changing the accessories or storing the tool.
- Keep the tool out of the reach of children. People who are not familiar with the tool or who have not read these instructions should not use it. Tools are dangerous when used by untrained people.
- The tool must be regularly maintained. Regular tool maintenance reduces malfunctions and improves work efficiency.
- Check that the moving parts are working properly and that they are not jammed. Check that there are no broken or damaged parts that could impair the functioning of the tool. If the tool is damaged or faulty, do not use the tool anymore and bring it to a qualified service for repairs.
- Keep cutting tools sharp and clean. Carefully maintained tools with sharp edges are wedged less frequently and can be guided more easily.
- Never touch any part of the body of the cutting chain when the tool is operating. Before starting the tool, make sure that the cutting chain is not in contact with anything. A moment of inattention while using the tool may cause your garment or part of the body to stick to the cutting chain.
- Wear safety glasses and hearing protection. Additional protective equipment is recommended such as helmets, protective gloves, slip-resistant foot protection and safety clothes.
- Do not place yourself on the path of falling branches.
- Before felling, check where the trees or branches are going to fall. Make sure that there are no obstacles to prevent or hinder travel.
- Do not work in areas where the grass is wet and where the soil is slippery.
- Do not use this tool in a tree, on an unstable ladder or surface.
- Adopt a stable position and keep your balance constantly.
- Hold the tool firmly with both hands when the engine is running.
- When the chain is moving, it must not touch objects, materials or persons.
- Start cutting only with a chain at full speed.
- Do not attempt to insert the saw into a pre-existing notch. Always make a new notch.
- Pay attention to moving branches or other forces that could close a notch and pinch or hinder the chain.
- Do not attempt to cut a branch with a diameter greater than the cutting length of the chain saw.
- Always switch off the tool, let the chain completely stop before making any adjustments, maintenance, cleaning or repairs.
- The chain must remain sharp and taut. Regularly check the tension of the chain.
- Only use replacement parts and original accessories.
- Use only the manufacturers specified replacement guides and chains. Incorrect replacement guides and chains may cause chain breakage and / or rebound.
- Check that there are no obstacles or electrical wires hidden in the work area.
- Immediately stop the device if an abnormal level of vibration has been detected. In case of damage to the blade, it is necessary to change the complete set of blades.
- Use the device only if all protective devices are mounted. Do not use the device with faulty protective equipment. Do not modify the unit.
- Do not work with the tool when it rains, in bad weather or in a damp environment. Do not use the machine when there is a risk of thunderstorms and storms.
- Only work outdoors, under daylight or under artificial lighting.
- Always carry the appliance by its handle
- Tie long hair in a way to prevent them from coming into contact with the blades. Do not wear jewelry and loose clothing when operating the machine.
- The appliance should never be used near people, especially children and pets. Stop the operation

immediately if this condition is not met. In all cases, ensure a safe area of at least 15 meters around the work area.

- The operator is responsible for accidents caused to others.
- Always take a stable working position. Make sure about your step on the slopes. Take extreme caution when working on slopes.
- Take regular breaks to reduce the risk of fatigue.
- Never leave the machine unattended.
- The device must always be used fully assembled and secured.
- Store the tool with its blade guard and out of the reach of children
- Never use an incomplete or unauthorized tool.
- Clean and maintain the tool before storage (see the chapters on this manual). Bring maintenance after each use according the instructions of this manual. Improper maintenance can reduce the life of the tool, bring bad results and wear the tool and its accessories.
- Check the tool regularly and before each use to observe any impact or damage.

Residual risks

Even if you use this product in compliance with all safety requirements, the potential risks of injury and damage remain. The following hazards may arise in the structure and design of this product:

- There are harmful health consequences resulting from the emission of vibrations if the product is used for long periods of time or not properly managed and properly maintained.
- There is risk of injury and property damage due to attachments or broken the sudden impact of hidden objects when using cutting.
- Risk of injury to persons and property caused by flying objects.
- Prolonged use of this product exposes the operator to vibration and can produce so-called "white finger" disease. To reduce the risk, wear gloves and keep your hands warm.
- If any of the symptoms of "white finger syndrome" occur, seek immediate medical attention. Symptoms of the "white finger" include numbness, loss of sensitivity, tingling, tingling, and pain, loss of strength, color changes or skin condition. These symptoms usually appear on the fingers, hands or wrists. Risk increases at low temperatures.

Intended use

1) Brushcutter and grass trimmer

Intended use

This machine can be used as a trimmer with the cutting edge, and as a brushcutter with the cutting blade.

The grass trimmer must be strictly and only to cut grass or weeds that are not too dense. The brush cutter must be used to cut hard grass, more dense weeds and small branches with a maximum diameter of 10mm.

Improper use

This machine is not intended to cut bushes or others similar plants requiring the tool to get off the ground. Do not use this tool to work other materials such as stones, clay soils, etc.

2) Mounted pole pruner

Intended use / improper use

The pole pruner is exclusively intended for pruning trees and/or cutting small wood from the ground. Any other use is considered improper and will damage the tool.

The correct use also includes reading and observing the instructions for use at each use as well as observing the warnings fixed on the machine. Before and during use, it is imperative to check the blade to ensure that there is no mechanical damage. In case of necessary repairs, please contact your specialist dealer.

Only the use of spare parts approved by the manufacturer or original spare parts is permitted. If unauthorized or non-original spare parts are used, the user is liable for consequential injury to persons or property resulting in the manufacturer being deprived of all liability.

3) **Hedge trimmer**

Intended Use

Your hedge trimmer is a device used by a person to trim hedges and shrubs by working with one or more blades arranged linearly and back and forth. A potential hazard exists if the device is used for other purposes. Improper handling of the hedge trimmer increases the risk of injury from blades. Only the use of spare parts and accessories approved by the manufacturer is permitted.

Symbols on the machine



Warning symbol



Wear an equipment of protection including a helmet, protective glasses, hearing protection



Wear hearing protection



Wear ocular protection



Wear protective gloves



Wear protective and non-skid shoes



Read the instruction manual



Risk of projection – keep bystanders away - The distance between the machine and bystanders shall be at least 15 m.



Do not use saw blades



Guarantee noise level



Warning! Cutting elements



Caution: the accessible surface maybe hot when using the tool



Keep 15 meters away from other people



Wait until all machine components have completely stopped before touching them,



Poisonous fumes or toxic gases



Do not expose to rain or humidity



No naked fire near the machine



Caution! Beware of blade thrust



Warning – Risk of electric shock. Always beware of the danger from overhead electric-power line, keep a safe distance at least 10m from the power line

PARTS LIST

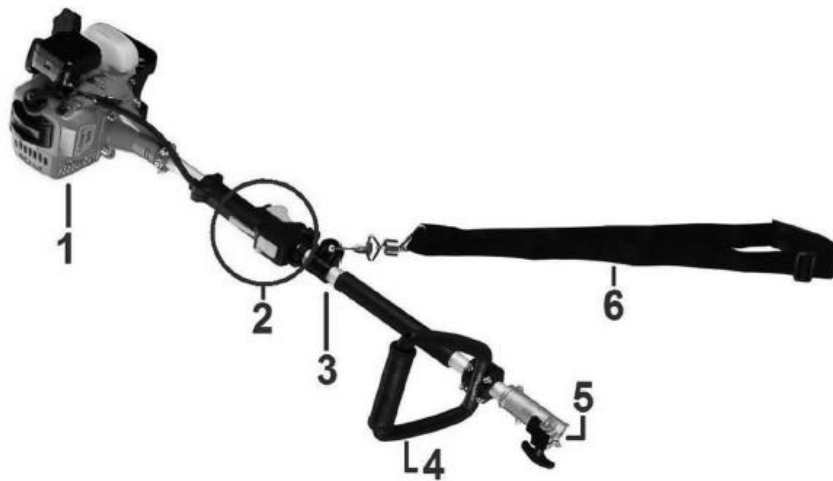

Fig.1a

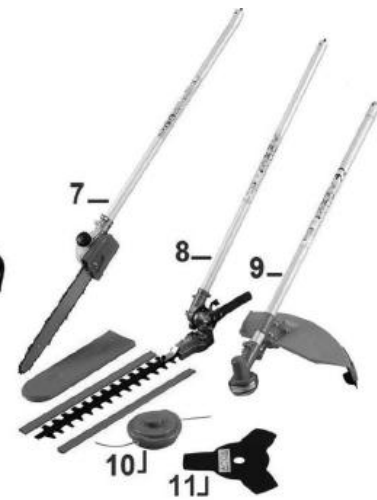

Fig.1b

- 1- Engine unit
- 2- Control unit
- 3- Main pole
- 4- Handle
- 5- Connection
- 6- Shoulder strap
- 7- Pole Pruner head
- 8- Edge trimmer head
- 9- Brush cutter & Grass trimmer head
- 10- Nylon spool
- 11- Blade

ENGINE

1. PARTS LIST

- 1 Engine unit
- 2 Spark plug
- 3 Recoil starter
- 4 Air filter assembly
- 5 Fuel tank
- 6 Wiring
- 7 Shaft
- 8 Handle
- 9 Throttle trigger
- 10 Throttle lockout lever
- 11 Throttle lock button
- 12 Ignition On/Off switch
- 13 Hook for shoulder strap



Fig.2

TECHNICAL INFORMATION

Engine information	
Volume of the fuel tank	1250 cm ³
Max engine speed	9500 min ⁻¹
Engine idling speed	3000 min ⁻¹
Clutch engagement speed	3910 min ⁻¹
Engine displacement	52 cm ³
Maximal power	1,45 kW / 7500/min
Weight	Max. 7,91 kg
Noise level and vibration	Sound power level: 105,4 dB(A) Guarantee sound power level: 111dB(A) Sound pressure level: 96,2 dB(A) Uncertainties K = 3 dB(A) Vibration - Front handle: · Idling: 8,303 m/s ² · Racing: 7,723 m/s ² - Rear handle: · Idling: 7,737 m/s ² · Racing: 6,763 m/s ² - K = 1,5 m/s ²

Brushcutter	
Cutting diameter	1.4x255mm
Maximum rotational frequency of the spindle	9500 min ⁻¹
Cutting blade	3T
Hedge trimmer	
Cutting length	Cutting wide: 24mm; Cutting range:430mm
Type of the hedge trimmer blade	Double
Maximum rotational frequency of the spindle	9500min ⁻¹
Grass trimmer	
Cutting diameter	430mm
Maximum rotational frequency of the spindle	9500min ⁻¹
Cutting string head	∅ 2.5mm max
Pole pruner	
Cutting length	10" 25.4 cm
Oil tank	150cm ³
Chain type	10" ZLA10-39-507P
Type of the chain guide bar	JL9D-3*39
Maximum rotational frequency of the spindle	9500min -1

1. CHARACTERISTICS

2. SPECIAL SAFETY INSTRUCTIONS

2.1. See above

2.2. Symbols on the machine



(a) (a) The port to refuel the “mix gasoline”. Position: fuel tank cap



(b) The direction to close the choke. Position: air cleaner cover



(c) The direction to open the choke. Position: air cleaner cover

3. GETTING STARTED

3.1. Handle assembly (Fig.3)

1. Place unit on flat, hard and clean surface
2. With a Hex key, open the mounting collar.
3. Place handle over the tube.

Fix with the mounting collar.

- Tighten firmly the screws.



Fig.3

3.1. Shoulder strap assembly (Fig.4)

Insert shoulder strap clip on the hook.

Adjust shoulder strap to your desired length. Fig.4



Fig.4

3.2. Mixing fuel

1. Use only fresh, clean unleaded gasoline with an octane rating of 90 or above.
2. Mix all fuel with 2-cycle engine oil at a ratio of 25:1.

CAUTION!

This engine is to be operated on a 25:1 mixture consisting of unleaded gasoline and 2-cycle mixing oil only.

Some gasoline contains alcohol as oxygenate!

Oxygenated fuels may cause increased operating temperatures. Under certain conditions, alcohol-based fuels may also reduce the lubricating qualities of some mixing oils. Never use any fuel containing more than 10% alcohol by volume! When an oxygenated fuel must be used, fuel containing an oxygenate such as MTBE is to be preferred over an alcohol based fuel.

Generic oils and some outboard motor oils may not be intended for use in high-performance air cooled 2-cycle engines, and should never be used in a this engine

Important! Only mix enough fuel for your immediate needs! If fuel must be stored longer than 30 days, it should first be treated with a stabilizer.

• Filling the fuel Tank

3. Place the tank on a flat, level and clean surface.
4. Clear any dirt or other debris from around the fuel filler cap.
5. Remove the fuel cap, and fill the fuel tank with clean, fresh fuel mixture.
6. Install and firmly tighten the fuel cap.
7. Wipe up any spilled fuel from the power head before restarting

WARNING!

- Always allow the product to cool before refueling!
- Wipe all spilled fuel and move the product at least 3 meters (10 feet) from the fueling point before restarting!
- Never smoke or light any fires near the product or fuels!
- Never place any flammable material near the engine muffler!
- Never operate the engine without the muffler and spark arrestor in place and properly functioning!
- Never operate this machine if fuel system components are damaged or are leaking.

8. Warning considerations for handling fuel

- a. The engine of this product is designed to run on a mixed fuel, which contains highly X flammable gasoline. You should never store cans of fuel or refill the fuel tank in any place where there is a boiler, stove, wood fire, electrical sparks, welding sparks or any other source of heat or flame or fire which might ignite the fuel.
- b. Smoking while operating the product or refueling the tank is extremely dangerous F) and must be avoided. Always be sure to keep lit cigarettes away from the product at all times.
- c. When refilling, the tank always turn off the engine first and take a careful look around to mate sure that there are no sparks or open flames anywhere nearby before refueling.
- d. If any fuel spillage occurs during refueling, use a dry rag to wipe up spills before turning the engine back on again.
- e. After refueling, screw the fuel cap back tightly onto the fuel tank and then carry the brush cutter to a spot 3m or more away from where it was refueled before turning on the engine.

9. OPERATION

9.1. Starting the engine

1. Slide the ignition switch to the "I" (start) Position. See Fig.5.
2. Place choke lever on closed position IN (Fig.6).
3. Prime the engine by depressing the carburetor primer bulb four or five times (see Fig.7). You should be able to see fuel inside the bulb.
4. Push unlocking knob (fig.8)
5. Maintain the throttle lever half depressed (Fig.9)
6. Start engine (see 5.2)

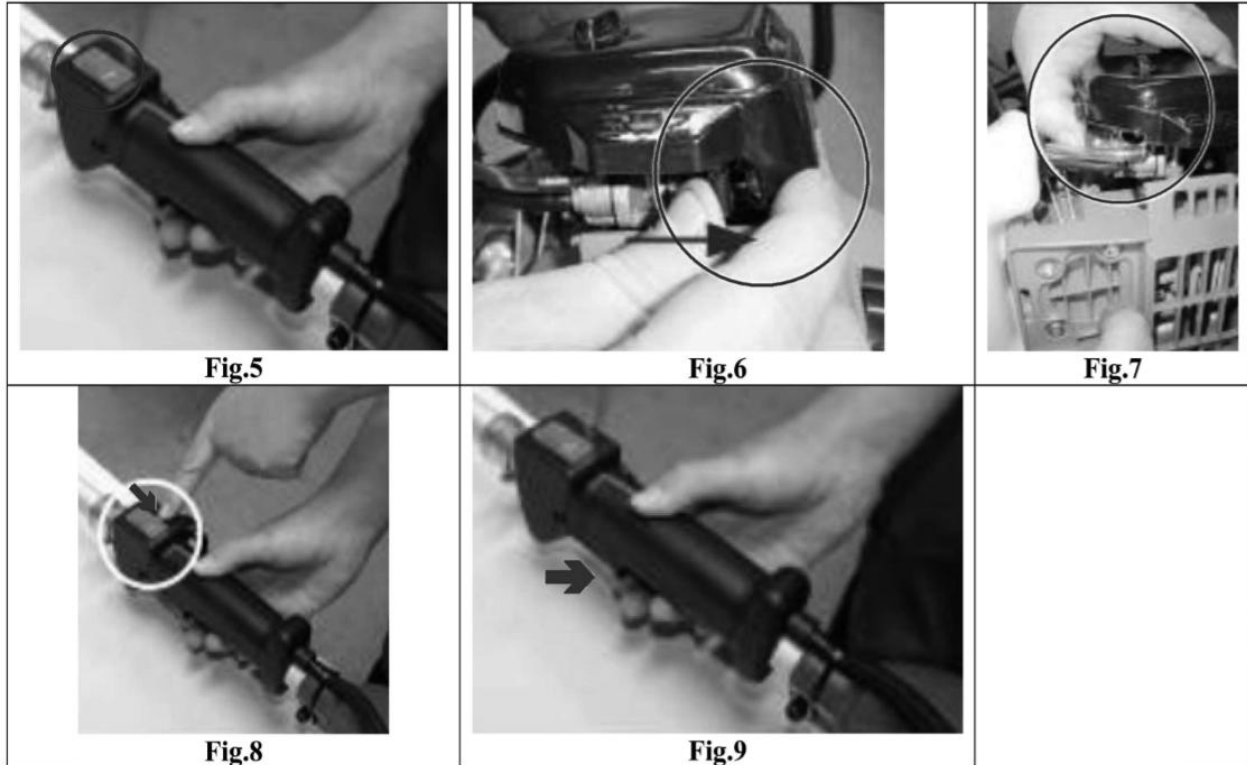

Important! Engine ignition is controlled by a two-position START-STOP switch mounted on the throttle body, typically labeled "T" for START and "0" for STOP

7.2. Cranking the engine

CAUTION!

1. Never operate the product unless a cutting attachment is installed.
2. The recoil starter can be damaged by abuse. - Always engage the starter before attempting to crank the engine. - Never pull the starter cord to its full length. - Always rewind the starter cord slowly.

WARNING! When starting the engine, make sure the cutting attachment is well clear of bystanders, pets or objects. The attachment may rotate during startup.

1. Place the unit firmly on the ground, making sure it is stable and that the cutting attachment is free and clear of any bystanders or objects.

Hold onto the hand grip on the outer tube with your left hand grasp the starter rope handle with your right hand. See Fig.10.

2. Pull the starter handle slowly until you feel the starter engage.
3. Then, pull the starter handle quickly to start the engine.

When the engine starts, open the choke by moving the choke lever down. II (Fig.11)

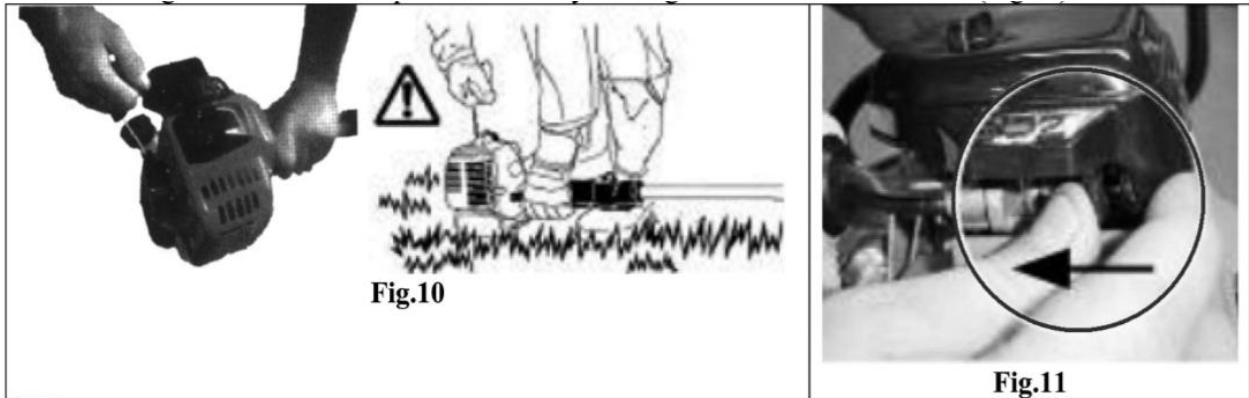

WARNING! The cutting attachment will engage and rotate as the engine starts and accelerates. If the engine did not continue to run, repeat the appropriate cranking procedure (warm or cold engine). When the engine starts, clear excess fuel from the combustion chamber by revving the engine several times with the throttle trigger (operating the trigger will automatically disengage the "fast idle" setting).

7.2.1. If the engine fails to start

Repeat the appropriate cranking procedure (warm or cold engine).

If the engine fails to start after repeated attempts, the engine is likely flooded. Proceed to the following procedure (see 5.4).

7.3. Starting a flooded engine

1. Disconnect the spark plug lead and then use the spark plug wrench to remove the spark plug (turn counterclockwise to remove). See Fig.12.

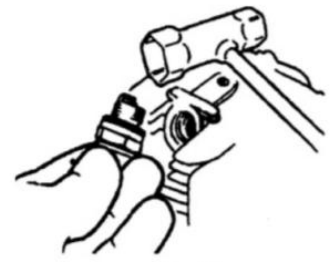

If the spark plug is fouled or soaked with fuel, clean the plug as necessary

2. Open the choke and fully depress the throttle trigger with your left hand, then pull the starter handle rapidly with your right hand to clear excess fuel from the combustion chamber. Fig.12

CAUTION! Incorrect spark plug installation can result in serious engine damage

3. Reinstall the spark plug and tighten it firmly. If a torque wrench is available, torque the spark plug to 16.7-18.6N.m.
4. Repeat the starting procedure.
5. If the engine still fails to start inquire with an authorized and qualified service centre.

7.4. Stop the engine

WARNING! The cutting attachment can continue rotating after the 4 engine is switched off!

- 1.1. Cool the engine by letting run idle for two or three minutes.
- 1.2. Slide the ignition switch to the "0" or STOP position. See Fig.13.



Fig.13

7.5. Checking and adjusting the idle speed

WARNING!

- The cutting attachment must never rotate at engine idle speed.
- The engine must return to idle speed whenever the throttle trigger is released
- Idle speed is adjustable and must be set low enough to permit the engine clutch to disengage the chainsaw when throttle trigger is released.

1. Start the engine and allow it to idle two or three minutes, or until it warm Up.
2. If the cutting attachment rotates at engine idle, reduce idle speed by turning the idle adjusting screw counter clockwise as necessary.



Fig.14

Important! Use a tachometer, if available, to set engine idle. Standard idle speed is: 3000 + 200.

3. If the engine is stalling and does not idle, increase idle speed by tuning screw the idle adjustment screw clockwise.

8. MAINTENANCE

8.1. General Maintenance

WARNING! Before performing any maintenance, repair, or cleaning work on the machine, make sure the engine and cutting attachment are completely stopped. Disconnect the spark plug wire before performing service or maintenance work

WARNING! Non-standard parts may not operate properly with your unit and may cause damage and lead to personal injury

8.1.1. Muffler

WARNING! Operating the engine without a muffler or with a muffler that is damaged or improperly installed can increase engine noise sufficiently to lead to hearing loss.

This machine must never be operated with a faulty or missing spark arrestor or muffler.

Make sure the muffler is well secured and in good condition. A worn or damaged muffler is a fire hazard and may also cause hearing loss.

8.1.2. Spark Plug Keep the spark plug and wire connections tight and clean.

8.1.3. Daily Maintenance

Prior to each work day, perform the following:

1. Remove all dirt and debris from the engine, check the cooling fins and air cleaner for clogging, and clean as necessary. See Fig.E18
2. Carefully remove any accumulating of dirt or debris from the muffler and fuel tank, dirt build-up in these areas can lead to engine overheating, fire, or premature wear.
3. Check for loose or missing screws or components. Make sure the cutting attachment is free of debris and securely fastened.
4. Check the entire machine for leaking fuel or grease.
5. Make sure nuts, bolts, and screws (except carburetor adjusting screws) are tight.

8.2. 10-Hour maintenance

CAUTION! Do not operate the machine if the air cleaner or element is damaged, or if the element is wet or water soaked

Every 10 hours of operation (more frequently in dusty or dirty conditions):

Remove the air cleaner element from the air cleaner housing and clean it thoroughly.

Rinse and dry thoroughly.

Add a few drops of oil, then reassemble the element. See Fig.15

8.3. 10/15-Hour Maintenance

CAUTION! Before removing the spark plug, clean the area around the plug to prevent dirt and dust from getting into the engine's internal parts

Every 10 to 15 hours of operation:

Remove and clean the spark plug. See Fig.16.

Adjust the spark plug electrode gap to 0.6-0.7mm.

Replace the spark plug as necessary

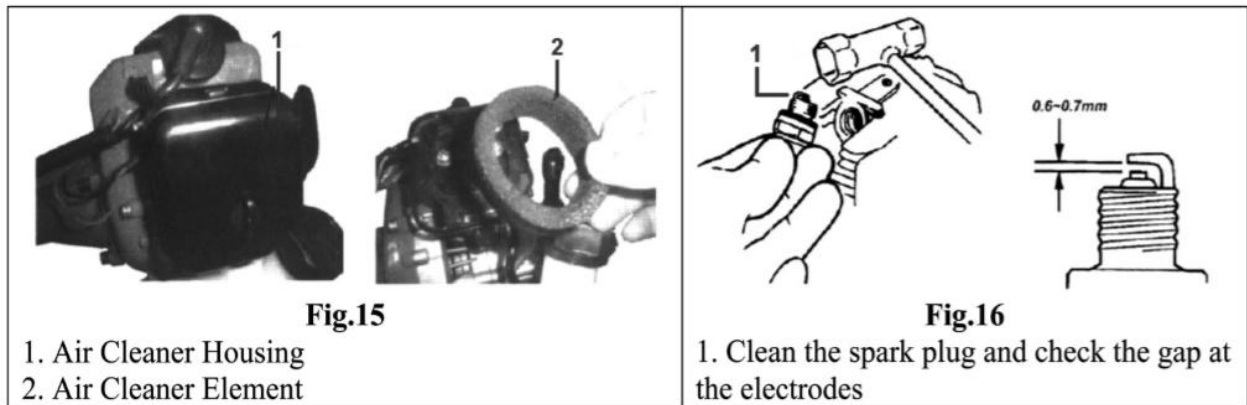

Fig. 15 :

1.2.1. Air Cleaner Housing

1.2.2. Air Cleaner Element

Fig. 16 : 1. Clean the spark plug and check the gap at the electrodes

BRUSH CUTTER & EDGE TRIMMER

1. Parts List

1. Tube
2. Protector shield
3. Gear case
4. Cutting device (blade or nylon thread)



Fig.BC1

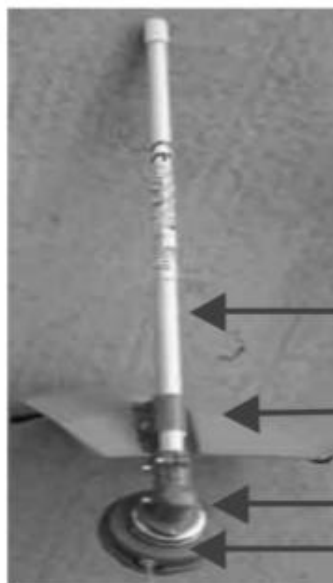

Fig.BC1a

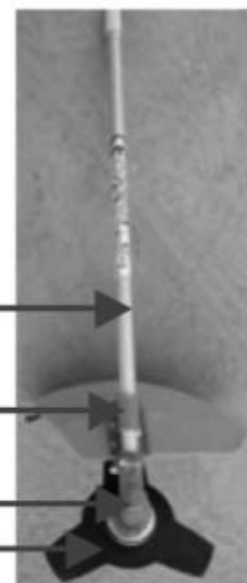

Fig.BC1b

2. Special Safety Instructions

2.1. Warning labels on machine

2.2. Safety Precautions

2.2.1. Before using the machine

- a. Read this manual carefully to understand how to operate this unit properly.
- b. This product has been designed for use in cutting grass, and it should never be used for any other purpose.
- c. You should never use his brush cutter when under the influence of alcohol, when suffering from exhaustion or lack of sleep, when suffering from drowsiness as a result of having taken cold medicine, or at any other lime when a possibility exists that your judgment might be impaired or that you might not be able to operate the brush cutter property and in a safe manner.
- d. Avoid running the engine indoors. The exhaust gases contain harmful carbon monoxide.
- e. Never use your brush cutter under any of the following circumstances:
 1. when the ground is slippery or when other conditions exist which might make it impossible to maintain a steady posture while using the brush cutter.
 2. At night, at time of heavy fog, or at any other time when your field of vision might be limited and it would be difficult to gain a clear view of the area.
 3. During rain, storms, during lightning storms, at times of strong or gale-force winds, or at any other time when weather conditions might make it unsafe to use the product.
- f. When using this product for the first time, before beginning actual work, learn lo handle the brush cutter from skilled worker.
- g. Lack of sleep, tiredness, or physical exhaustion result in lower attention spans, and it leads to accidents and injuries. Limit the amount of time over which the brush cutter is to be used continuously to somewhere around 30-40 minutes per session, and take 10-20 minutes of rest between work sessions. Also try lo keep the total amount of work performed in a single day under 2hours or less.
- h. Be sure to keep this manual handy so that you may refer to it later whenever any question arises. Always be sure to include this manual when selling, lending or otherwise transferring the ownership of this product. Never allow children or anyone unable to fully understand the directions given in this manual to use this product.

2.2.2. Working gear and clothing

When using this product, you should wear proper clothing and personal protective equipment such as:

1. Helmet
2. Face protection
3. Protective gloves
4. Working boots with non-slip sole
5. ear protection

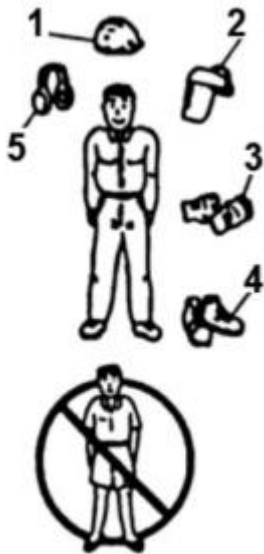

Never use the product when wearing pants with loose cuffs, sandals, or when barefoot.

2.2.3. Things to check before using your brush cutter

- a. Before beginning work look around carefully to get a feel for the shape of the land, or grass to be trimmed and whether or not there are any obstacles, which might get in the way while working, and remove any obstacles which can be cleared.
- b. The area within a perimeter of 15m of the person using the brush cutter should be considered a hazardous area into which no one should enter while the brush cutter is in use, and when necessary yellow warning rope, warning signs should be placed around the work area. When work is to be performed simultaneously by two or more persons, always check the presence and locations of others so as to maintain a safety distance between each person.
- c. Make sure that there are no loose screws or bolts, fuel leaks, ruptures, dents, or any other problems, which might interfere with safe operation. Be especially careful to check that there is nothing wrong with the blades / nylon wire or with the joints by which the blades / nylon wire are attached to the brush cutter.

- d. Never use blades that are bent, warped, cracked, broken or damaged in any way.
- e. Keep the blade always sharp.
- f. Filing the cutting edges, keep the end corner sharp and round the root of the edge.
- g. Check the bolt to fasten the blade and be sure the blade turns smoothly without abnormal noise.

2.2.4. Notes on starting the engine

- Take a careful look around to make sure that no obstacles exist within a perimeter of 15m or less around the brush cutter.
- Place the body of the brush cutter onto the ground in a flat clear area and hold it firmly in place so as to ensure that neither the blades / nylon wire nor the throttle come into contact with any obstacles when the engine starts up.
- Place the throttle into the idling position when starting the engine.
- After starting up the engine, if the blades continue to rotate even after the throttle has been moved fully back, turn off the engine and check the throttle wire and other parts.

2.2.5. Kickback safety precautions

A dangerous reaction may occur when the spinning blade contacts a solid object in the critical area. It is called kickback. As a result, the operator can lose control of the unit, which can cause serious or fatal injury. Avoid kickback; observe the safety precautions below strictly.

- Before beginning work, clear your working area and remove grasses around the obstacles.
- When using your brush cutter, do not grip other parts except the handles.
- When using your brush cutter, never take your eyes off, even if you need to place the throttle into the idling position.
- When using your brush cutter, do not let the unit get closer to your feet nor raise the unit above your waist

2.2.6. Notes on transportation

- Make sure the appropriate blade cover is in place.
- When transporting by car, fix the unit firmly using a rope.
- Do not transport by bicycle or motorcycle as it is dangerous.
- Never transport the brush cutter over rough roads over long distances without first removing all fuel from the fuel tank, as doing so might cause fuel to leak from the tank.

2.2.7. Operation safety precautions

- Grip the handles of the brush cutter firmly with both hands. If you suspend the work, place the throttle into the idling position.
- Always be sure to maintain a steady, even posture while working,
- Maintain the speed of the engine at the level required to perform cutting work, and never raise the speed of the engine above the level necessary.
- If the grass gets caught in the blade during operation, or if you need to check the unit or refuel the tank, always be sure to turn off the engine.
- If the blade touches a hard object like a stone, immediately stop the engine and check if something is wrong with the blade. If so, replace the blade by new one.
- If someone calls out while working, always be sure to turn off the engine before turning around
- Never touch the spark plug or plug cord while the engine is in operation. Doing so may result in being subjected to an electrical shock.
- Never touch the muffler, spark plug, or other metallic parts of the engine while the engine is in operation or immediately after shutting down the engine. Doing so may result in serious burns.
- When you finish cutting in one location and wish to continue work in another spot, turn off the engine and turn the unit with the blade facing away from your body.



2.2.8. Maintenance safety precaution

- Perform the maintenance and checking operations described in this manual at regular intervals, if any part must be replaced or any maintenance or repair work not described in this manual must be performed, please contact the nearest authorized servicing dealer for assistance.
- Under no circumstances should you ever take apart the brush cutter or alter it in any way. Doing so might result in the brush cutter becoming damaged during operation or the brush cutter becoming unable to operate properly.
- Always be sure to turn off the engine before performing any maintenance or checking procedures.
- When sharpening, removing, or reattaching the blade, proper tools and equipment are required to prevent injury.
- When replacing blade or any other part or when replacing the oil or any lubricant, always be sure to use products or products which have been certified for use with the brush cutter.

GETTING STARTED

1. Set Up

1.1. Accessory

Insert the lower tube (c) into the main pole tube (a) until shaft (b) aligns into position. Ensure assembly is tight and secured.

1.2. Gear case

Check screws of gear case and tighten if necessary. (Fig.BC3)

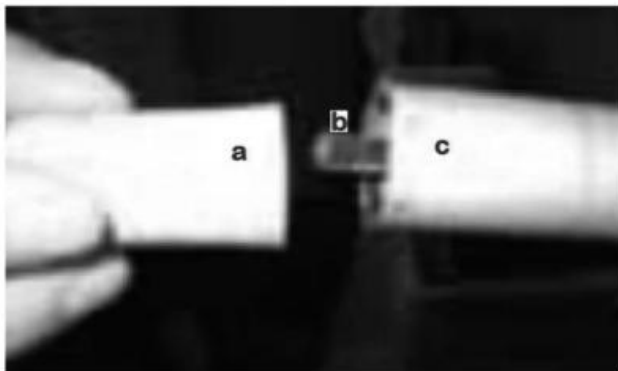

Fig.BC2

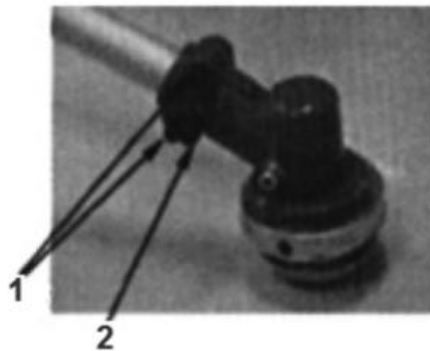

Fig.BC3

1.3. Safety guard

Attach the safety guard to the main tube (3), above the gear case and fix it with the clamp and bolts securely (Fig.BCA4).

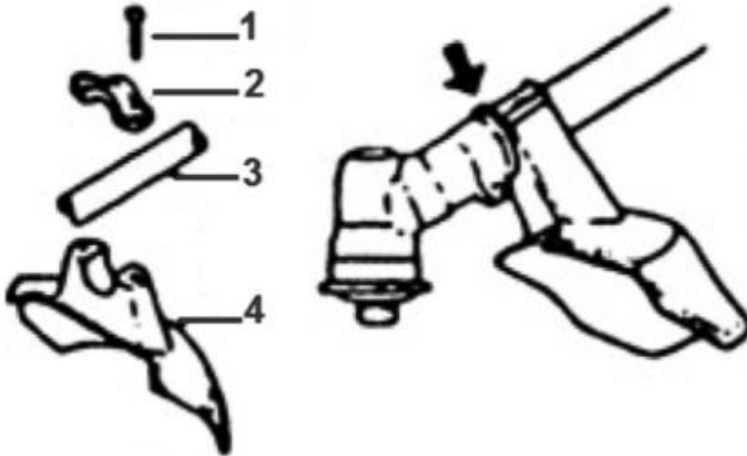

Fig.BC4a



Fig.BC4b

1. Bolt
2. Clamp
2. Main tube
3. Safety guard

1.4. Installing the metal blade (Fig.BCS)

3. Set the inner holder to the gear shaft, and turn to fix with the attached L-shaped bar (hex-key).
4. Put the blade on the inner holder with letters to the gear case, and match correctly the hole of the blade to the projection of the inner holder.
5. Set the outer holder to the gear shaft with the hollowed face to the blade.
6. Put the attached bolt cover on the outer holder and secure it with the bolt (left screw) together with the spring washer

1.5. Installing the nylon wire spool (Fig.BC6)

1. Set correctly the inner holder and the outer holder to the gear shaft
2. Screw the attached bolt (M8 left) into the gear shaft and secure it with the spanner

3. Screw the nylon cutter spool into the bolt by fixing the inner holder with the L-shaped (hex-key) bar and tighten it manually.

NOTE: Keep bolts and washers to install the blade carefully so as not to lose them.

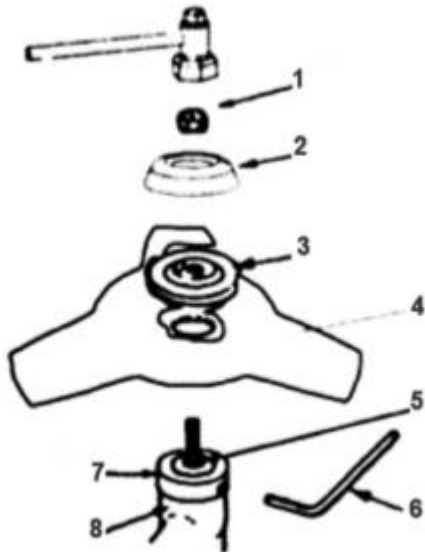

1. Nut
2. Outer holder 1
3. Outer holder 2
4. Blade
5. Gear shaft
6. Bar (hex-key)
7. Inner holder
8. Gear case

Fig.BC5

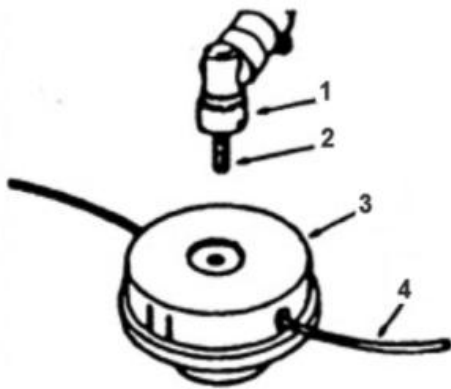

1. Gear case
2. Bolt
3. Nylon cutter spool
4. Nylon wire

Fig.BC6

1.6. Wearing the Strap (Fig. BC7)

1. Hook the strap hook to hanger on the outer pipe.
2. Wear the strap so that the hook stays at your right hand side.
3. Adjust the length of the strap so that you can hold and operate machine comfortably.

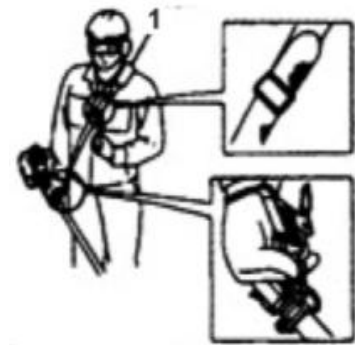

Fig.BC7
1. Strap

2. OPERATION

2.1. Intended use

- The product is intended for domestic use.
- The product is intended for cutting grass and trimming edges

2.2. Cutting operation

2.2.1. Metal blade usage (Fig.BC8)

Always cut by guiding the head from your right to left.

A metal blade cuts best up to the point 1/3 from the edge. Use that area for cutting shrubs, tough and thick weeds.

For cutting young grass, you can use up to 2/3 from the tip of blade. Adjust the engine speed according to the cutting objects.

Cut the young grass at middle speed, and cut shrubs or tough and thick weeds at high speed.

1. For shrubs and tough/thick weeds,
2. For grass and weeds,
3. Direction of cutting
4. Direction of rotation

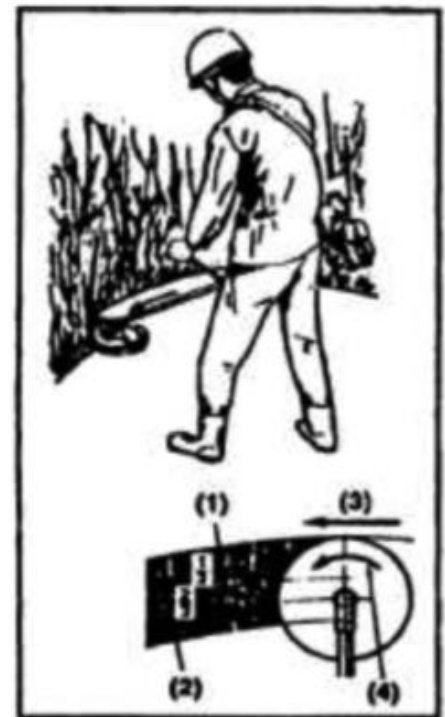

Fig.BC8

IMPORTANT! Operating at low speed makes it easier for grass, weeds, or twigs to become caught up in the blades, and also it makes the shaft and clutch wear down more quickly.

2.2.2. Nylon cutter usage

Nylon cord consumes large power.

Please note that the engine rotation speed in operation should be 50% as large as when using metal blade

Nylon cutter cuts grass with the power of cord rotation. If you try to cut grass for the length of cord at one time, rotation speed becomes lower due to resistance and you cannot cut well.

In case of large resistance, get the nylon cutter away from grass once, make the rotation speed higher, and cut a small amount of grass at one time.

If you try to cut grass by swinging the brush cutter in the reverse way (from left to right), scraps fly in the direction away from the body. You can avoid getting your clothes dirty.

3. MAINTENANCE

3.1. Blades (Fig.BC9)

Sharpen each cutting blade after 25h of use and make sure the bottom corner is rounded. Do not cool the blade with water in case of using a grinder. It may cause cracks on blade.

3.2. Gear Case (Fig.BC10)

Supply multi-purpose grease at every 25 hours of use. Remove the cutter holders to arrange for old grease to exit.



Fig.BC9



Fig.BC10

3.3. Before storage

- Brushing off dirt from the machine, check damage or slack of each part. If you find out abnormalities, have them repaired before the next use.
- Extract fuel from the tank, and loose the drain screw of the float cabin to extract fuel, turn on the engine, and leave it running until it stops naturally.
- Remove the spark plug and put in 1-2cc of 2-cycle oil in the engine.
- Draw the starter rope 2-3 times, set the plug back, and stop it at the contraction position.

- Apply anti-rust oil to the metal parts such as the throttle wire, put the cover on the blade, and keep it indoor avoiding dampness.

POLE PRUNER

1. PARTS LIST

1. Guide bar
2. Chain
3. Oil tank
4. Oil Cap EF
5. Gear case
- 6.Chain cover
- 7.Tube



Fig.PP1

2. SPECIAL SAFETY INSTRUCTIONS

CAUTION!

- Always maintain this pole pruner according to the owner's manual and follow the recommended scheduled maintenance.
- Never modify or disable any of the pole pruner's safety devices.
- Always use genuine parts and accessories when repairing or maintaining this machine.
- Do not make unauthorized modifications or substitutions to the guide bar or chain
- Never allow the engine to run at high RPM without a load. Doing so could damage the engine.
- When transporting the pruner in a vehicle, tie it down securely to prevent damage and fuel spillage.
- Always stop the engine and allow it to cool before refueling. Avoid overfill and wipe off any fuel that may have spilled.
- Never place flammable material close to the engine muffler and never run the engine without the spark arrestor screen in place.
- Always clear your work area of trash or hidden debris to help ensure good footing. Plan an escape route to avoid falling branches.
- Keep the saw chain sharp and properly adjusted.
- Keep the pruner as clean as possible. Keep it free of loose vegetation, mud, etc.

2.1 Safety Operation



The pole pruner is not insulated against electrical shock!

- Approaching or contacting electrical lines with the pole x pruner could cause death or serious injury.
- Keep the pole pruner at least 10 meters away from electrical lines or branches that contact electrical lines This machine is designed especially for cutting small branches.

Never use this machine for any other purposes. Never try to cut stones, metals, plastics or any other hard objects.

Using for other purposes than cutting branches may damage the machine or cause serious injury. Always wear eye and ear protection. Manufacturer recommends wearing a face shield as additional face and eye protection.

Always wear a hard hat to reduce the risk of head injuries during operation of this machine.

Wear non-slip heavy-duty work gloves to improve your grip on the pole pruner handle.

Wear snug-fitting clothes that, also permits freedom of movement.

NEVER wear shorts!

Wear sturdy footwear with no slip soles to provide good footing.

Steel-toes safety boots are recommended.

Keep bystanders at least 15 meters (50 feet) away from the operating pruner to reduce the risk of being struck by falling objects or debris.

Never operate the pruner at an angle greater than 60° in order to reduce the risk of being struck by falling objects during operation.

Always operate with both hands firmly gripping the machine.

Keep a proper footing and do not overreach-Maintain your balance at all times during operation.

2.2 Kickback precautions

A dangerous reaction may occur when the spinning chain contacts a solid object or gets stuck in the wood...

It is called kickback. As a result, the operator can lose control of the unit, which can cause serious or fatal injury. To avoid kickback, operate the pruner smoothly.

3. GETTING STARTED

3.1 Assembly

3.1.1 Assembly of accessory head (see Fig.BC2)

Insert the lower tube (c) into the main pole tube (a) until shaft (b) aligns into position. Ensure assembly is tight and secured

3.1.2 Installing the Chain

WARNING! Never attempt to install, replace, or adjust the chain with the engine running.

WARNING! The saw chain is very sharp. Wear gloves to protect your hands when handling.

NOTE: For longest chain life, let new or replacement chain loops soak in oil overnight before installation

- Using the small end of the plug wrench, remove the sprocket cover nut (turn counterclockwise to remove) and remove the sprocket cover. See Fig.PP2

CAUTION! Failure to align the guide bar and chain tensioning pin can cause serious damage to the sprocket cover, guide bar, chain tensioning pin and cutting head assembly

- Place the guide bar over the guide bar adjustment stud on the cutting head assembly. Align the chain tensioning pin with the hole in the guide bar. See Fig.PP3
- Install the chain loop over the drive links within the guide bar groove, and then align the chain over the drive sprocket. Make sure the cutters are properly oriented as shown in Fig.PP4.

If chain installation is difficult or if the chain appears too tight, refer to the section "Adjusting the Chain".

- Install the sprocket cover over the bar stud.

Using finger-pressure only, install the sprocket cover nut.

WARNING! Never operate the pole pruner without the sprocket cover installed

- Refer to the next section for chain adjusting procedures.

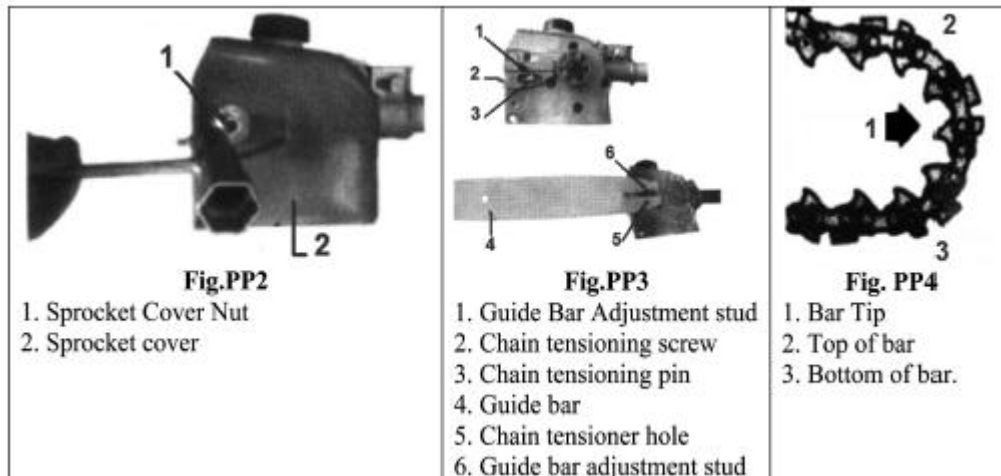

Fig.PP2:

1. Sprocket Cover Nut
2. Sprocket cover

Fig.PP3:

1. Guide Bar Adjustment stud
2. Chain tensioning screw
3. Chain tensioning pin
4. Guide bar
5. Chain tensioner hole
6. Guide bar adjustment stud

Fig.PP4:

1. Bar Tip
2. Top of bar
3. Bottom of bar

3.1.3 Adjusting the Chain

WARNING! Never attempt to install, replace, or adjust the chain with the engine running
WARNING! The saw chain is very sharp. Wear gloves to protect your hands when handling.
CAUTION! A loose chain can jump off the guide bar causing damage to the chain and associated equipment. Always make sure the chains is properly adjusted; check more often when you are breaking in a new chain

IMPORTANT: Proper chain adjustment is essential for maximum performance, long chain life, and operator safety. Always inspect chain tension before operating the pole pruner.

1. Place the pole primer on a clean, flat Surface. (For readjustment during operation, shut down the engine, then allow the guide bar and chain to cool before proceeding with the adjustment procedure.
2. Loosen the sprocket cover nut with a plug wrench (Fig. PPS)
3. Lift the nose of the guide bar while turning the chain tensioning screw. See Fig.PP6
 - Clockwise to tighten the chain
 - Counterclockwise to loosen the chain.
4. Pull the chain by hand along the top of the guide bar several times from the engine to the bar's tip. The chain should feel snug but still pull freely. See Fig.PP7.
5. Tighten the sprocket cover nut securely while lifting the tip of the guide bar.
6. Inspect the chain for correct adjustment (more frequently with a new chain). The chain should feel snug but still pull freely.

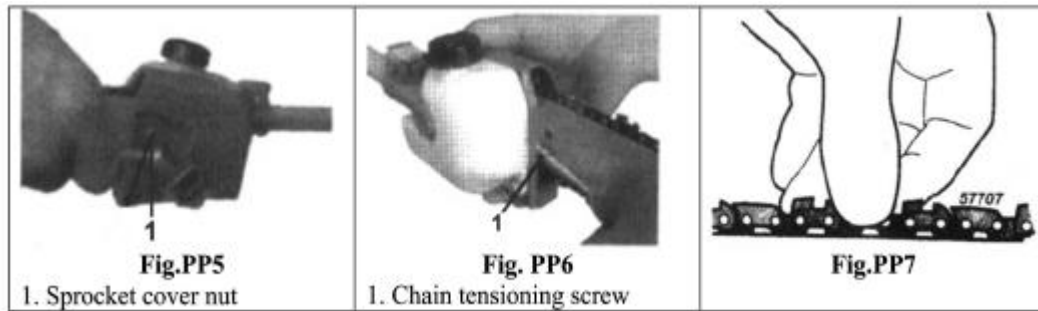

Fig. PP5:

1. Sprocket cover nut

Fig. PP6:

1. Chain tensioning screw

3.2 Chain Oiler

WARNING! Never fill the oil reservoir nor adjust the oiler with the engine running

IMPORTANT: The service life of the chain and guide bar is affected by the chain and guide lubricant. Using superior lubricant such as genuine Bar and Chain Oil will help ensure a long service life. For cold weather operation, mix bar and chain oil with an equal part of kerosene.

3.2.1 Filing the Oil Reservoir

The oil reservoir has a capacity sufficient to provide about 40 minutes of cutting time (when set to deliver the minimum flow rate)

1. Place the pole pruner on a clean, flat surface with the oil filler cap facing up. See Fig PP8.

Wipe off any debris from the oil cap and from around the oil filler neck.

2. Remove the oil filler cap (1) and fill the reservoir with bar and chain oil, then replace the cap (1).
3. Wipe up spilled oil from the unit before restarting the pole.

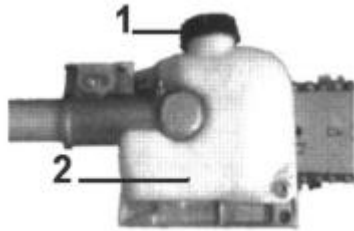

Fig.PP8

1. Oil filter cap pruner. 2. Oil reservoir

3.2.2 Adjusting Oil Flow Rate

CAUTION! An increase in bar oil flow rate will speed oil consumption, requiring more frequent checks on the oil reservoir. To ensure sufficient lubrication, it may be necessary to check the oil level more frequently than at fuel tank refills.

The guide bar and chain are lubricated automatically by a pump that operates whenever the chain rotates.

The pump is set at the factory to deliver a medium flow rate, but it can be adjusted in the field.

Adjust the pump as follows:

1. Stop the engine and make sure the stop switch is in the STOP position. Fig.PP9
2. Place the unit on its side with the oil reservoir up. See Fig.PP9.
3. With a screwdriver, push in on the oil flow rate adjusting screw and turn in the desired direction (there are two incremental settings):
 - Clockwise - decrease lubrication.
 - Counterclockwise - increase lubrication

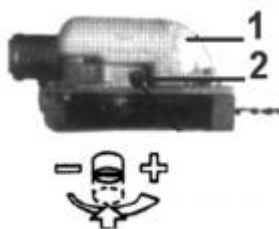

Fig.PP9

1. Oil reservoir
2. Oil flow adjusting screw

CAUTION! The oil flow adjusting screw must be pressed in slightly in order to turn. Failure to do so could damage the Pump and screw.

3.3 Wearing the Strap (see BC7)

1. Hook the strap hook to the hanger on the outer pipe.
2. Wear the strap so that the hook stays at your right hand side.
3. Adjust the length of the strap so that you can hold and operate the machine comfortably.

3.4 Preparation

4. Wear suitable protective clothing and equipment-see section "safety Precautions".
5. Choose the best work position for safety against the falling object (Branch etc)
6. Start the engine.
7. Put on the strap.
8. Never stand directly underneath the branch you are cutting - be wary of falling branches. Note that a branch may spring back at you after it hits the ground.

OPERATION

8.1. INTENDED USE

- The product is intended for domestic use.
- The product is intended for cutting branches

8.2. CUTTING SEQUENCE

Always cut the lower branches first so as to allow branches a free fall. Prune heavy branches (large diameter) in several controllable pieces.

8.3. WORKING POSITION

Hold the control handle with your right hand, and the shaft with your left hand. Your left arm should be extended to the most comfortable position. The shaft should always be held at an angle of 60° or less.

8.4. STANDARD CUT (Fig. PP10)

The most convenient working position is a tool angle of 60°, but any other angle may be used to suit the situation concerned.

8.5. CUTTING ABOVE OBSTACLES (Fig. PP11)

Thanks to the unit's long reach it is possible to prune branches that are overhanging obstacles, such as rivers or lakes. The tool angle in this case depends on the position of the branch

8.6. CUTTING ON A WORK PLATFORM (Fig. PP12)

The unit's long reach enables cutting to be performed next to the trunk without the risk of the work platform damaging other branches.

The tool angle in this case depends on the position of the branch.

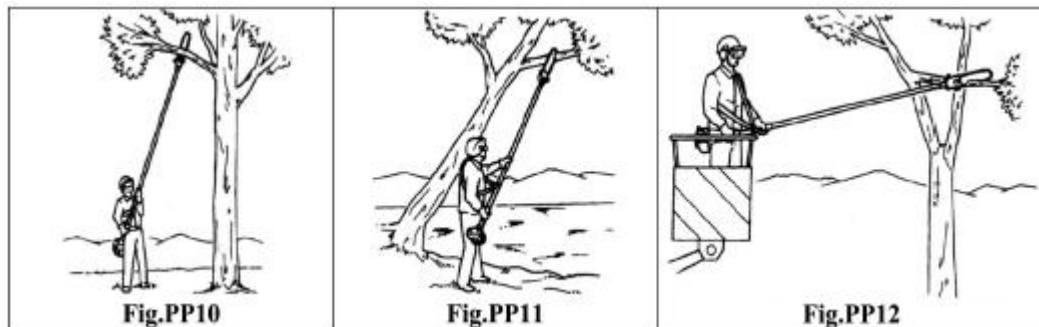

7. WORKING TECHNIQUES

7.1- Relieving cut (Fig. PP13)

To avoid tearing the bark, kickback or pinching the bar when pruning thick branches, always start by performing a relieving cut (1) on the underside of the branch.

To do this apply the cutting attachment and pull it across the bottom of the branch as far as the bar nose.

Perform the cross-cut (2).

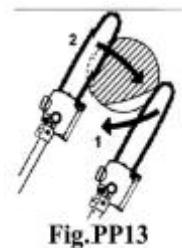

7.2- Flush-cutting thick branches (Fig. PP14)

If branch diameter is more than 10cm (4"), first perform undercut (3) and cross-cut at a distance (A) of about 25cm (10") from the final cut. Then carry out the flush-cut (4), starting with a relieving cut and finishing with a cross-cut.

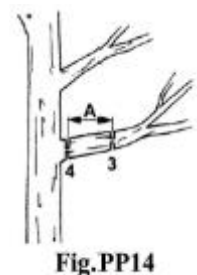

MAINTENANCE

8.6.1. 50-HOUR MAINTENANCE

Every 50 hours of operation (more frequently in dusty or dirty conditions):

1. Remove and clean the cylinder cover and clean dirt and debris from the cylinder cooling fins.
2. Remove the sprocket cover and inspect the sprocket for excessive dirt, debris, or wear.

Remove the guide bar and clean out the guide bar groove.

3. If the sprocket is excessively worn, replace it with a new one. (See Fig.PP15)
4. Lubricate the gear case. To perform this operation, first remove the gear case from the upper outer tube as follows (See Fig.PP16):
 - Using a lever-type grease gun, pump lithium-base grease (about 10 grams) into the grease fitting until you see old grease being purged from the gear case, this can be seen in the outer tube cavity.

Clean up excess grease, and then reassemble the gear case onto the outer tube

5. Use a wire hook to extract the fuel filter from inside the fuel tank (See Fig.PP17).

CAUTION! Make sure you do not pierce the fuel line with the end of the hooked wire. The line is delicate and can be damaged easily.

Inspect the fuel filter element for signs of contamination.

Replace it with a new one if required. Before reinstalling the filter, inspect the fuel line. If you find damage or deterioration, remove the unit from service until it can be inspected by a trained service technician.

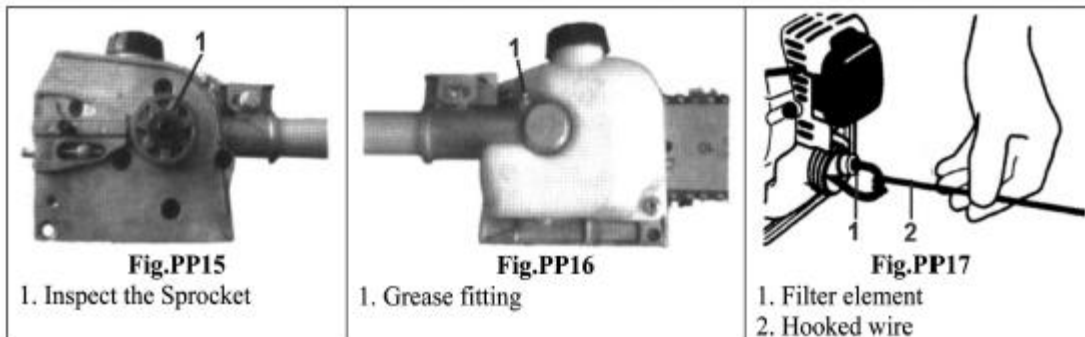

8.6.2. SHARPENING THE CHAIN

When the cutting edges of the blade become dull, they can be re-sharpened with a few strokes of a file.

In order to keep the blade in balance, all cutting edges must be sharpened equally. In addition, inspect the chain for correct adjustment (more frequently with a new chain).

The chain should feel snug but still pull freely. See Fig.PP18

8.6.3. SHARPENING INSTRUCTIONS (Fig.PP19)

IMPORTANT: File all cutters to the same angle and depth! Unequal filing may cause the saw to vibrate or cut erratically! –

- Using a 4.5mm round file, sharpen all cutters to a 30° angle. Make sure that one fifth (20%) of the file's diameter is always held above the cutter's top plate.

NOTE: For consistent filing angles, use a filing guide.

- After all cutters are sharpened; use a depth gauge joiner to measure the height of each depth gauge.
- As required, lower the depth gauges to a height of 0.5mm. Use a flat file.
- After all depth gauges have been adjusted, use a flat file to round each depth gauge leading edge to its original curvature and angle.

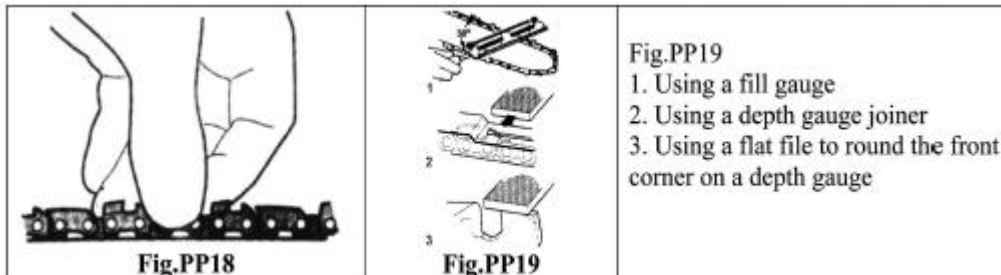

1.Using a fill gauge

2.Using a depth gauge joiner

3.Using a flat file to round the front corner on a depth gauge

HEDGE TRIMMER

1. PARTS LIST

1. Blade protection
2. Blades
3. Gear case
4. Handle
5. Latch lock/unlock
6. Tube



Fig.HT1

2. SPECIAL SAFETY INSTRUCTIONS

CAUTION!

1. Always maintain the articulated hedge trimmer according to this owner's manual and follow the recommended scheduled maintenance.
2. Never modify or disable any of the hedge trimmer's safety devices.
3. Always use genuine machine parts and accessories when repairing or maintaining this
4. Do not make unauthorized modifications to the articulated hedge trimmer.
5. When transporting the hedge trimmer in a vehicle, tie it down securely to prevent fuel spillage or damage to the machine.
6. Always clear your work area of trash or hidden debris to help ensure good footing.
7. Keep the cutters sharp and properly adjusted.
8. Keep the articulated hedge trimmer as clean as possible. Keep it free of loose vegetation, mud, debris, etc.

WARNING! Never transport the articulated hedge trimmer or set it down with the engine running. An engine that's running could be accidentally accelerated causing the blades to oscillate. Make sure the blade cover is in place when transporting and storing the articulated hedge trimmer.

When carrying an articulating hedge trimmer, the blade of the cutting attachment must be in the transport position. See Fig.HT2



Fig.HT2

Fig.HT2: Blade folded in transport position

3.1. Safety Operation



The articulated hedge trimmer is not insulated against electric shock!

3. Approaching or contacting electrical lines with the trimmer could cause death or serious injury.
4. Keep the trimmer at least 10 meters away from electrical lines or branches that contact electrical lines.

An articulated hedge trimmer has the potential to do serious damage if misused, abused or mishandled. To reduce the risk of injury, you must maintain control at all times, and observe all safety precautions during operation. Never permit a person without training or instruction to operate this machine!

This machine is designed especially for trimming hedges

Never use this machine for any other purposes. Never try to cut stones, metals, plastics or any other hard objects.

Using for other purposes than trimming hedges may damage the machine or cause serious injury. Always wear eye and ear protection. Manufacturer recommends wearing a face shield as additional face and eye protection. Secure long hair above shoulder level.

Always wear a hard hat to reduce the risk of head injuries during operation of this machine.

Wear non slip heavy-duty work gloves to improve your grip on the trimmer handle.

Wear snug-fitting clothes that also permit freedom of movement.

NEVER wear shorts!

Wear sturdy footwear with non-slip soles to provide good footing.

Steel-toes safety boots are recommended.

Keep bystanders at least 15 meters (50 feet) away from the operating trimmer to reduce the risk of being struck by falling or projected objects or debris.

Keep a proper footing and do not overreach - maintain your balance at all times during operation. Always operate with both hands firmly gripping the machine.

4. GETTING STARTED

4.1. Installing the hedge trimmer cutter head (see Fig.BC2)

WARNING! The cutter blades are very sharp. Do not handle the cutter assembly unless the protective blade cover is in place.

IMPORTANT! Always wear gloves when working with or near the cutter assembly.

9. Make sure the cutter bar is locked in the storage/transport position (folded back) and the protective cover is installed over the cutter blades.
10. Insert the lower tube (c) into the main pole tube (a) until shaft (b) aligns into position. Ensure assembly is tight and secured.
11. With a screwdriver, check that all screws are correctly tightened (Fig.HT3).

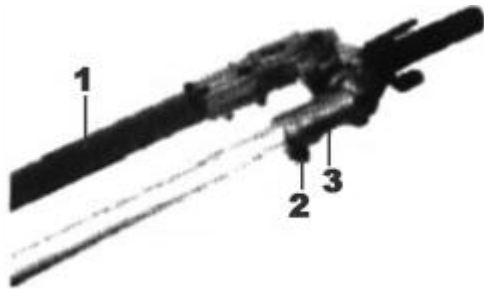

Fig.HT3

1. Protective cover must be in place
2. Tighten the screw (if needed)

4.2. Adjusting the Articulated Hedge Trimmer

4.2.1. Cutter Assembly

WARNING! The cutter blades are very sharp. Do not grasp the blades with your hands. Do not brush the blades against your body.

Never run the engine or operate the articulating hedge trimmer when the cutter assembly is in the storage/ transport position.

IMPORTANT! Always use gloves when working with or near the cutter assembly.

Position the hedge trimmer on a flat, level surface with the engine resting on the fuel tank guard.

Make sure the hedge trimmer blade cover is in place.

- With your right hand, grasp the handle, located immediately aft of the hand guard. With your left hand, grip the adjustment lever on the cutter assembly. See Fig.HT4
IMPORTANT! The latch lock provides an interlock to help prevent inadvertent depression of the latch release.
- With the index finger of your left hand, press the latch release. With your left thumb, press the latch lock. See Fig.HT5
- While holding the latch lock down, pivot the cutter assembly using the adjustment lever until it is straight with the outer tube (pivot 180°). See Fig.HT6.
- Release the latch lock anti the latch release. Make sure the latch lock and the latch release return securely to a locking position,
- Remove the cover from the cutter blade. The engine now may be started.

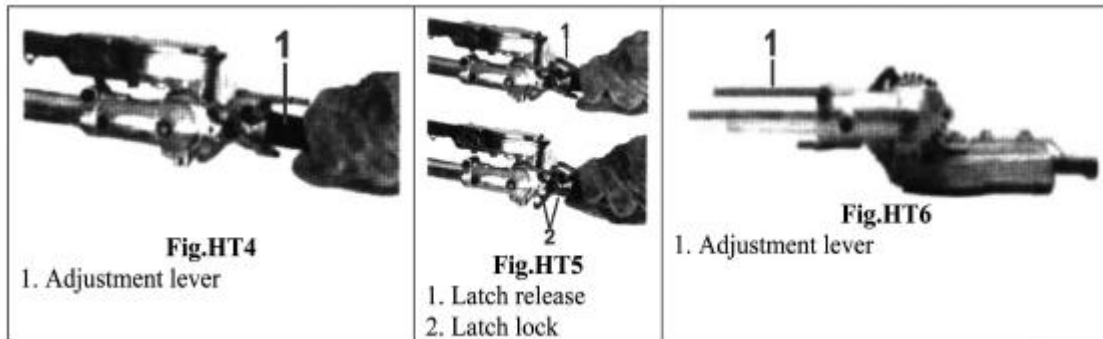

Fig.HT4: Adjustment lever

Fig.HT5:

1.Latch release

2.Latch lock

Fig.HT6:

1.Adjustment lever

4.2.2. Cutter assembly for desired cutting angles

WARNING! Do not touch the cutter blades when the engine is running. The blades can oscillate even if the engine is idling. The cutter assembly can be adjusted to 10 different positions ranging from 120° to 270° from the outer tube as shown in Fig.HT7. Refer to the steps on the previous page for the adjustment procedures. Always make sure the lock latch is securely locked after each adjustment



Fig.HT7

4.2.3. Cutter assembly for storage or transportation

WARNING! Never run the engine when adjusting the cutter assembly to the storage position

1. With the engine stopped, install the cover onto the blade.
2. Using the procedures described on the previous page, rotate the cutter assembly so it is parallel to the tube.

Make sure the latch lock and the latch release return securely to a locking position. See Fig.HT8.

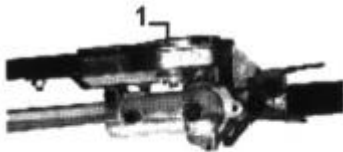

Fig.HT8

1. Gear case rotated to the storage / transportation position

Fig.HT8:

1. Gear case rotated to the storage / transportation position
3. Make sure the cover is in place on the cutters before storing or transporting

4.3. Wearing the Strap

1. Hook the strap hook to the hanger on the outer pipe.
2. Wear the strap so that the hook stays at your right-hand side.

3. Adjust the length of the strap so that you can hold and operate the machine comfortably.

4.4. Preparations

1. Wear suitable protective clothing and equipment-see section "Safety Precautions".
2. Choose the best work position for safety against falling or projected object or debris.
3. Start the engine,
4. Put on the strap.
5. Never stand directly underneath the branch you are cutting-be wary of failing branches. Note that a branch may spring back at you after it hits the ground.

5. OPERATION

5.1. Intended use

- The product is intended for domestic use.
- The product is intended for trimming hedges

5.2. Cutting sequence

If a radial cut is necessary, cut a little at a time in several passes.

5.3. Working position

Hold the control handle with your right hand, and the shaft with your left hand. Your left arm should be extended to the most comfortable position.

NOTE: Take a rest when you feel fatigue

5.5. Cutting techniques (Fig. HT9 ; HT10; HT11; HT12)

5.5.1. Vertical cut:

Swing the cutting blade up and down in an arc as you move along the hedge: use both sides of the cutting blade.

5.5.2. Horizontal cut:

Hold the cutting blade at an angle of 0° to 10° as you swing the hedge trimmer horizontally. Swing the blade in an arc towards the outside of the hedge so that the cuttings are swept on to the ground.

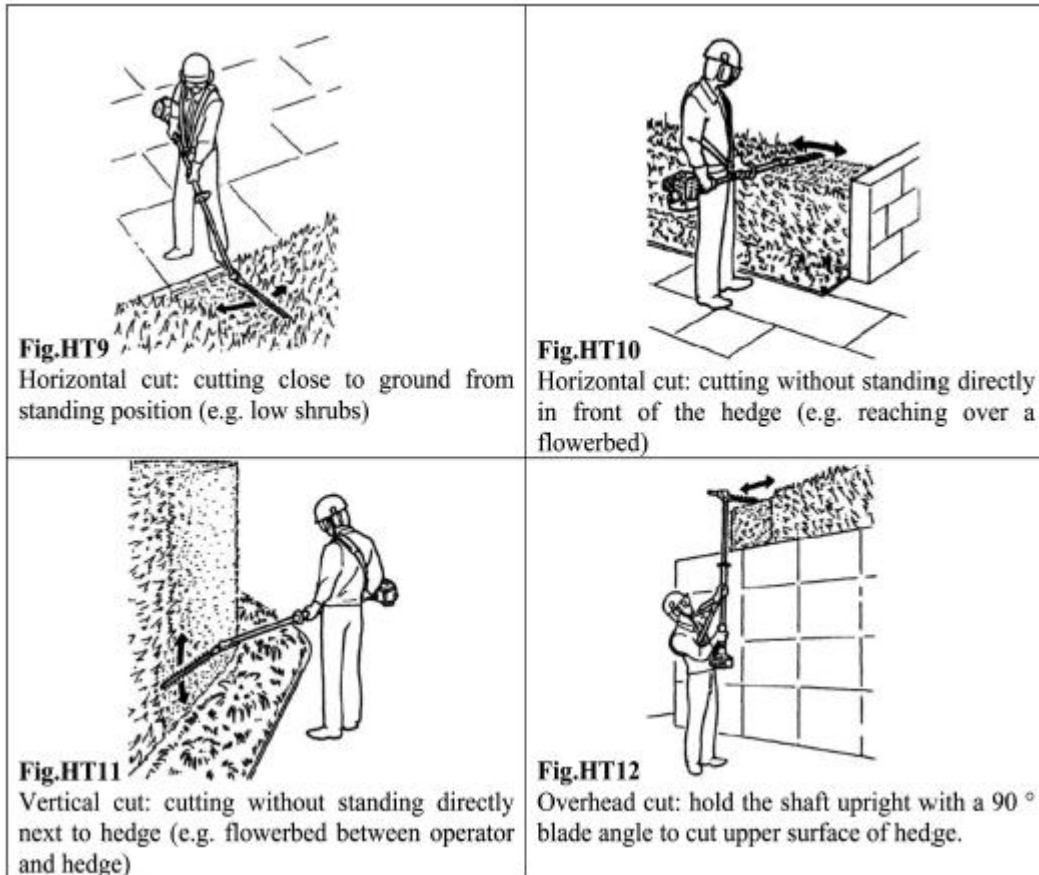

6. MAINTENANCE

6.1. Daily maintenance

WARNING! Always wear gloves when working around the cutter assembly.

- Clean any debris or dirt from the hedge trimmer cutter blades. Lubricate the blades before use and after refueling. Check the cutters for damage or incorrect adjustment.
- Check for loose or missing screws or components.
- Make sure the cutter attachment is securely fastened.
- Check the entire machine for leaking fuel or grease.
- Make sure the nuts, bolts, and screws (except carburetor adjusting screws) are tight.

WARNING! Before performing any maintenance, repair, or cleaning work on the unit, make sure the engine and cutting attachment are completely stopped. Disconnect the spark plug wire before performing service or maintenance work.

WARNING! Non-standard parts may not operate properly with your unit and may cause damages and lead to personal injury.

6.2. 10/15-hour maintenance

Lubricate the cutter assembly gearbox by pumping one or two strokes of lithium-base grease into the grease fitting using a lever-type grease gun. See Fig.HT13

CAUTION! Over-lubricating can cause the gear case to operate sluggishly and can cause grease to leak out.

6.3. 50-Hour Maintenance

Every 50 hours of operation (more frequently in dusty or dirty conditions):

1. Remove and clean the cylinder cover and clean the dirt and debris from the cylinder cooling fins.
2. Lubricate the gear case. To perform this operation, first remove the gearcase from the outer tube (See Fig.HT14)

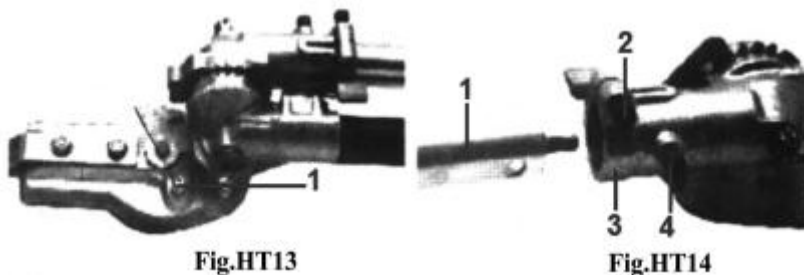

Fig. HT13: 1. Gear case grease fitting

Fig.HT14 1. Outer tube 2. Gear case clamp bolt 3. Gear case 4. Index bolt

CAUTION! Do not remove the D-shaped shim washer from the gearcase clamp! The shim washer prevents damage from over-tightening the tube damp screw.

- a. Loosen the gear case clamp bolt.
- b. Remove the index bolt from the gear case.
- c. Slide the gear case out of the tube. Using a grease gun, pump lithium-base grease (about 10 grams) into the grease fitting on the gear case until you see old grease being purged from the gear case (Fig.HT15). Purged grease will be visible in the outer tube cavity. Clean up the excess grease and then reassemble the gear case onto the outer tube.

Make sure the index bolt fits into the hole on the outer tube. Securely tighten both bolts.

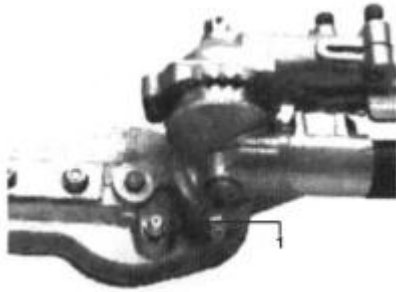

Fig.HT15

1. Gear case Grease fitting

7. MAINTENANCE AND STORAGE for the WHOLE MULTIFUNCTION TOOL



Before any intervention on product, ensure that motor is off.

7.1. General Product Maintenance

Clean plastic parts with a soft clean cloth.

Do not use aggressive cleansers (solvents or abrasive cleansers), or an abrasive sponge or sharp objects.

Do not put or immerse product in water or any other liquid.

7.2. Long Term Storage

Product must be stored in a dry location. Always lock up product and keep out of reach of children. Whenever the machine will not be used for 30 days or longer, use the following procedures to prepare it for storage:

1. Clean external parts thoroughly and apply a light coating of oil to all metal surfaces.

CAUTION! Gasoline stored in the carburetor for extended periods can cause hard starting, and could also lead to increased service and maintenance costs.

2. Drain all the fuel from the carburetor and the fuel tank.

IMPORTANT! All stored fuel should be stabilized with a fuel stabilizer.

3. Remove the spark plug and pour about 3cm³ of oil into the cylinder through the spark plug hole. Slowly pull the recoil starter 2 or 3 times so oil evenly coat the interior of the engine. Reinstall the spark plug.

4. Before storing the machine, repair or replace any worn or damaged parts. Make sure the scabbard is in place.

5. Remove the air cleaner element from the carburetor and clean it thoroughly. Rinse and dry thoroughly, then add a few drops of oil and work it in. Reassemble.
6. Store the machine in a clean, dust-free area.

7.3. Disposal

- **Cutting remnants:** do not throw with household rubbish or into the environment. Dispose of cutting remnants in rubbish collection centres or seek advice from your local municipality.
- **Tool:** do not dispose with household garbage. Do not throw into the environment.

Remove oil and fuel from the machine, and dispose them in specific recycling centers.

Dispose of the product in a waste collection centre; or seek advice from your local municipality.

- Proceed with disposal of remnants, tool, accessories, fuel mixture, oil and packaging according to local regulations regarding the protection of the environment.

8.TROUBLESHOOTING

Problems	Causes	Resolutions
The tool cannot be started	The starting process is not followed	Follow the instructions of use of this manual
	Spark plug dirty or moist	Clean the spark plug or replace it by a new one
	Incorrect carburettor adjustment	Contact your dealer or contact SWAP
The tool starts but no in a full power	Non-correct setting of the starter	Open the starter
	Air filter is dirty	Clean the air filter
	Incorrect carburettor adjustment	Contact your dealer or contact SWAP
The engine cannot reach its maximal power	Non-correct gap between the electrode and the spark plug	Clean the spark plug and adjust the gap between the electrodes or replace them with a new one
	Incorrect carburettor adjustment	Contact your dealer or contact SWAP
The engine generate of lot of smoke	Incorrect mix of the tank	Do a correct mix of the fuel (see the corresponding chapter)
	Incorrect carburettor adjustment	Contact your dealer or contact SWAP

9. DECLARATION OF CONFORMITY EU



BUILDER SAS

ZI, 32 RUE ARISTIDE BERGES 31270 CUGNAUX, FRANCE
Tel: +33 (0)534.502.50 Fax: +33 (0)534.502.503

Declares that the machines:

PETROL MUTIL-TOOL

Model: HCOMBI60-A

Serial No.: 20201237851-20201238730

the people name holding the technical file : M. Olivier Patriarca

have been designed in compliance with the following standards:

EN ISO 11680-1:2011
EN ISO 11806-1:2011
EN ISO 10517:2019
EN ISO 14982: 2009

And in accordance with the following directives:

Directive Machine 2006/42/EC
Directive EMC 2014/30/EU
Noise Directive 2000/14/EC & Annex V Directive 2005/88/EC
Emission directive (EU) 2016/1628 & 2018/989/EU

Sound power level: 105,4 dB(A)
Guarantee sound power level: 111dB(A)
Uncertainties K = 3 dB(A)

Philippe MARIE / PDG

A handwritten signature in black ink, appearing to read 'Philippe Marie', enclosed within a hand-drawn oval.

Cugnaux, 28/09/2020

10.WARRANTY

HYUNDAI

WARRANTY

The manufacturer guarantees the product against defects in material and workmanship for a period of 2 years from the date of the original purchase. The warranty only applies if the product is for household use. The warranty does not cover breakdowns due to normal wear and tear.

The manufacturer agrees to replace parts identified as defective by the designated distributor. The manufacturer does not accept responsibility for the replacement of the machine, in whole or in part, and/or ensuing damage.

The warranty does not cover breakdowns due to:

- insufficient maintenance.
- abnormal assembly, adjustment or operations of the product.
- parts subject to normal wear and tear.

The warranty does not extend to:

- shipping and packaging costs.
- using the tool for a purpose other than that for which it was designed.
- the use and maintenance of the machine done in a manner not described in the user manual.

Due to our policy of continuous product improvement, we reserve the right to alter or change specifications without notice. Consequently, the product may be different from the information contained therein, but a modification will be undertaken without notice if it is recognized as an improvement of the preceding characteristic.

READ THE MANUAL CAREFULLY BEFORE USING THE MACHINE.

When ordering spare parts, please indicate the part number or code, you can find this in the spare parts list in this manual. Keep the purchase receipt; without it, the warranty is invalid. To help you with your product, we invite you to contact us by phone or via our website:

- **+33 (0)9.70.75.30.30**
- **<https://services.swap-europe.com/contact>**

You must create a "ticket" via the web platform.

- Register or create your account.
- Indicate the reference of the tool.
- Choose the subject of your request.
- Describe your problem.
- Attach these files: invoice or sales receipt, photo of the identification plate (serial number), photo of the part you need (for example: pins on the transformer plug which are broken).



11.PRODUCT FAILURE

WHAT TO DO IF MY MACHINE BREAKS DOWN?

If you bought your product in a store:

- a) Empty the fuel tank.
- b) Make sure that your machine is complete with all accessories supplied, and clean! If this is not the case, the repairer will refuse the machine.

Go to the store with the complete machine and with the receipt or invoice.

If you bought your product on a website:

- a) Empty the fuel tank.
- b) Make sure that your machine is complete with all accessories supplied, and clean! If this is not the case, the repairer will refuse the machine.
- c) Create a SWAP-Europe service ticket on the site: <https://services.swap-europe.com> When making the request on SWAP-Europe, you must attach the invoice and the photo of the nameplate (serial number).
- d) Contact the repair station to make sure it is available before dropping off the machine.

Go to the repair station with the complete machine packed, accompanied by the purchase invoice and the station support sheet downloadable after the service request is completed on the SWAP-Europe site

For machines with engine failure from manufacturers BRIGGS & STRATTON, HONDA and RATO, please refer to the following instructions.

Repairs will be done by approved engine manufacturers of these manufacturers, see their site:

- <http://www.briggsandstratton.com/eu/fr>
- <http://www.honda-engines-eu.com/fr/service-network-page;jsessionid=5EE8456CF39CD572AA2AEEDFD290CDAE>
- <https://www.rato-europe.com/it/service-network>

Please keep your original packaging to allow for after-sales service returns or pack your machine with a similar cardboard box of the same dimensions.

For any question concerning our after-sales service you can make a request on our website <https://services.swap-europe.com>

Our hotline remains available at +33 (9) 70 75 30 30.



12.WARRANTY EXCLUSIONS

THE WARRANTY DOES NOT COVER:

- Start-up and setting up of the product.
- Damage resulting from normal wear and tear of the product.
- Damage resulting from improper use of the product.
- Damage resulting from assembly or start-up not in accordance with the user manual.
- Breakdowns related to carburetion beyond 90 days and fouling of carburetors.
- Periodic and standard maintenance events.
- Actions of modification and dismantling that directly void the warranty.
- Products whose original authentication marking (brand, serial number) has been degraded, altered or withdrawn.
- Replacement of consumables.
- The use of non-original parts.
- Breakage of parts following impacts or projections.
- Accessories breakdowns.
- Defects and their consequences linked to any external cause.
- Loss of components and loss due to insufficient screwing.
- Cutting components and any damage related to the loosening of parts.
- Overload or overheating.
- Poor power supply quality: faulty voltage, voltage error, etc.
- Damages resulting from the deprivation of enjoyment of the product during the time necessary for repairs and more generally the costs related to the immobilization of the product.
- The costs of a second opinion established by a third party following an estimate by a SWAP-Europe repair station
- The use of a product which would show a defect or a breakage which was not the subject of an immediate report and/or repair with the services of SWAP-Europe.
- Deterioration linked to transport and storage*.
- Launchers beyond 90 days.
- Oil, petrol, grease.
- Damages related to the use of non-compliant fuels or lubricants.

* In accordance with transport legislation, damage related to transport must be declared to carriers within 48 hours maximum after observation by registered letter with acknowledgement of receipt.

This document is a supplement to your notice, a non-exhaustive list.

Attention: all orders must be checked in the presence of the delivery person. In case of refusal by the delivery person, it you must simply refuse the delivery and notify your refusal.

Reminder: the reserves do not exclude the notification by registered letter with acknowledgement within 72 hours.

Information:

Thermal devices must be wintered each season (service available on the SWAP-Europe site). Batteries must be charged before being stored.

HYUNDAI
POWER PRODUCTS

For Inquiries, please contact:

BUILDER SAS

32, rue Aristide Bergès Z1 31270 Cugnaux, France

Tél. : +33 (0) 5.34.502.502 Fax : +33 (0) 5.34.502.503

<http://www.hyundaipower-fr.com/>

Fabriqué en République Populaire de Chine (PRC)