

# FEIDER

## MACHINES



### CORDLESS JIG SAW

FSS20V-A

### USER GUIDE

**CAUTION: READ THE INSTRUCTIONS BEFORE USING THE MACHINE!**

# CONTENTS

1. APPLICATION .....	3
2. SAFETY INSTRUCTIONS .....	3
3. YOUR PRODUCT.....	7
4. PACKAGE CONTENT LIST.....	8
5. OPERATION .....	8
6. CLEANING AND MAINTENANCE.....	11
7. TECHNICAL DATA.....	11
8. DISPOSAL.....	12
9. DELARATION OF CONFORMITY.....	12
10. WARRANTY.....	13
11. PRODUCT FAILURE.....	14
12. WARRANTY EXCLUSIONS.....	15

# 1. APPLICATION

The power tool is intended for sawing wood, metal and plastics. Not suitable for professional use.

## 2. SAFETY INSTRUCTIONS

### 2.1 GENERAL POWER TOOL SAFETY WARNINGS



**WARNING** Read all safety warnings, instructions, illustrations and specifications provided with this power tool. *Failure to follow all instructions listed below may result in electric shock, fire and/or serious injury.*

**Save all warnings and instructions for future reference.**

*The term "power tool" in the warnings refers to your mains-operated (corded) power tool or battery-operated (cordless) power tool.*

#### 1) Work area safety

- a) **Keep work area clean and well lit.** *Cluttered or dark areas invite accidents.*
- b) **Do not operate power tools in explosive atmospheres, such as in the presence of flammable liquids, gases or dust.** *Power tools create sparks which may ignite the dust or fumes.*
- c) **Keep children and bystanders away while operating a power tool.** *Distractions can cause you to lose control.*

#### 2) Electrical safety

- a) **Power tool plugs must match the outlet. Never modify the plug in any way. Do not use any adapter plugs with earthed (grounded) power tools.** *Unmodified plugs and matching outlets will reduce risk of electric shock.*
- b) **Avoid body contact with earthed or grounded surfaces, such as pipes, radiators, ranges and refrigerators.** *There is an increased risk of electric shock if your body is earthed or grounded.*
- c) **Do not expose power tools to rain or wet conditions.** *Water entering a power tool will increase the risk of electric shock.*
- d) **Do not abuse the cord. Never use the cord for carrying, pulling or unplugging the power tool. Keep cord away from heat, oil, sharp edges or moving parts.** *Damaged or entangled cords increase the risk of electric shock.*
- e) **When operating a power tool outdoors, use an extension cord suitable for outdoor use.** *Use of a cord suitable for outdoor use reduces the risk of electric shock.*
- f) **If operating a power tool in a damp location is unavoidable, use a residual current device (RCD) protected supply.** *Use of an RCD reduces the risk of electric shock.*

#### 3) Personal safety

- a) **Stay alert, watch what you are doing and use common sense when operating a power tool. Do not use a power tool while you are tired or under the influence of drugs, alcohol or medication.** *A moment of inattention while operating power tools may result in serious personal injury.*
- b) **Use personal protective equipment. Always wear eye protection.** *Protective equipment such as a dust mask, non-skid safety shoes, hard hat or hearing protection used for appropriate conditions will reduce personal injuries.*
- c) **Prevent unintentional starting. Ensure the switch is in the off-position before connecting to power source and/or battery pack, picking up or carrying the tool.** *Carrying power tools with your finger on the switch or energising power tools that have the switch on invites accidents.*
- d) **Remove any adjusting key or wrench before turning the power tool on.** *A wrench or a key left attached to a rotating part of the power tool may result in personal injury.*

e) **Do not overreach. Keep proper footing and balance at all times.** *This enables better control of the power tool in unexpected situations.*

f) **Dress properly. Do not wear loose clothing or jewellery. Keep your hair and clothing away from moving parts.** *Loose clothes, jewellery or long hair can be caught in moving parts.*

g) **If devices are provided for the connection of dust extraction and collection facilities, ensure these are connected and properly used.** *Use of dust collection can reduce dust-related hazards.*

h) **Do not let familiarity gained from frequent use of tools allow you to become complacent and ignore tool safety principles.** *A careless action can cause severe injury within a fraction of a second.*

#### **4) Power tool use and care**

a) **Do not force the power tool. Use the correct power tool for your application.** *The correct power tool will do the job better and safer at the rate for which it was designed.*

b) **Do not use the power tool if the switch does not turn it on and off.** *Any power tool that cannot be controlled with the switch is dangerous and must be repaired.*

c) **Disconnect the plug from the power source and/or remove the battery pack, if detachable, from the power tool before making any adjustments, changing accessories, or storing power tools.** *Such preventive safety measures reduce the risk of starting the power tool accidentally.*

d) **Store idle power tools out of the reach of children and do not allow persons unfamiliar with the power tool or these instructions to operate the power tool.**

*Power tools are dangerous in the hands of untrained users.*

e) **Maintain power tools and accessories. Check for misalignment or binding of moving parts, breakage of parts and any other condition that may affect the power tool's operation. If damaged, have the power tool repaired before use.** *Many accidents are caused by poorly maintained power tools.*

f) **Keep cutting tools sharp and clean.** *Properly maintained cutting tools with sharp cutting edges are less likely to bind and are easier to control.*

g) **Use the power tool, accessories and tool bits etc. in accordance with these instructions, taking into account the working conditions and the work to be performed.** *Use of the power tool for operations different from those intended could result in a hazardous situation.*

h) **Keep handles and grasping surfaces dry, clean and free from oil and grease.** *Slippery handles and grasping surfaces do not allow for safe handling and control of the tool in unexpected situations.*

#### **5) Battery tool use and care**

a) **Recharge only with the charger specified by the manufacturer.** *A charger that is suitable for one type of battery pack may create a risk of fire when used with another battery pack.*

b) **Use power tools only with specifically designated battery packs.** *Use of any other battery packs may create a risk of injury and fire.*

c) **When battery pack is not in use, keep it away from other metal objects, like paper clips, coins, keys, nails, screws or other small metal objects, that can make a connection from one terminal to another.** *Shorting the battery terminals together may cause burns or a fire.*

d) **Under abusive conditions, liquid may be ejected from the battery; avoid contact. If contact accidentally occurs, flush with water. If liquid contacts eyes, additionally seek medical help.** *Liquid ejected from the battery may cause irritation or burns.*

e) **Do not use a battery pack or tool that is damaged or modified.** *Damaged or modified batteries may exhibit unpredictable behaviour resulting in fire, explosion or risk of injury.*

f) **Do not expose a battery pack or tool to fire or excessive temperature.** *Exposure to fire or temperature above 130 °C may cause explosion.*

NOTE The temperature „130 °C“ can be replaced by the temperature „265 °F“.

g) **Follow all charging instructions and do not charge the battery pack or tool outside the temperature range specified in the instructions.** *Charging improperly or at temperatures outside the specified range may damage the battery and increase the risk of fire.*

## 6) Service

- a) **Have your power tool serviced by a qualified repair person using only identical replacement parts.** *This will ensure that the safety of the power tool is maintained.*
- b) **Never service damaged battery packs.** *Service of battery packs should only be performed by the manufacturer or authorized service providers.*

### Safety instructions for reciprocating saws

**Hold the power tool by insulated gripping surfaces, when performing an operation where the cutting accessory may contact hidden wiring or its own cord.** *Cutting accessory contacting a "live" wire may make exposed metal parts of the power tool "live" and could give the operator an electric shock.*

**Use clamps or another practical way to secure and support the workpiece to a stable platform.** *Holding the workpiece by hand or against your body leaves it unstable and may lead to loss of control.*

## 2.2 SPECIAL SAFETY INSTRUCTIONS FOR JIG SAWS



**Important! Use of any accessories or attachments other than those supplied or recommended in these operating instructions can mean the risk of injury.**

- When using jig saws ear protectors and a face mask should be worn. Exposure to noise can cause damage to hearing.
- Do not use the jig saw to cut asbestos or materials containing asbestos.
- Do not leave power tools running unattended. Always switch off and do not put down or leave until it has stopped completely.
- Long hair must be covered. Do not work in loose fitting clothing.
- Be careful when working on walls. Damage to power supply lines, gas or water pipes can lead to dangerous situations. Use appropriate detectors to establish whether there are concealed wires or pipes in the working area.
- Secure the work piece. The work piece is only secure if it is held by work-holding devices or in a vice.
- Caution: saw blades can get very hot.
- Saw blades must be kept sharp and in good condition. Replace partially fractured and broken saw blades immediately.
- Work calmly and evenly with the jig saw. You will thus avoid accidents and the saw blades and the jig saw will last longer.
- Do not use for cutting pipes or cables.
- Do not use cracked, blunt or damaged blades.
- Do not start the saw if no blade is fitted.
- Check there are no obstructions in/on the surface under the item to be cut.
- Do not attempt to cut items thicker than the maximum cutting depth of the blade, or where there is insufficient space for the blade under the item.
- The saw's metal parts may become conductive if the saw comes into contact with a live wire. Therefore only hold the saw by its insulated handle.
- Check that the ventilation slots are not blocked.
- Never remove dust, obstructions or the like from the work area while the blade is operating.
- Never stop the saw blade by applying pressure to the saw or to the side of the blade.
- Do not lift the saw from the item being cut if the blade is still running.
- Never place the saw on a table or workbench if it has not stopped completely.
- The saw blade will continue to run a short time after the machine has been switched off.

## 2.3 SAFETY INSTRUCTIONS FOR BATTERIES AND CHARGER

### Batteries

- Never attempt to open for any reason.
- Do not store in locations where the temperature may exceed 40°C (104°F).
- Charge only at ambient temperatures between 4°C and 40°C (39.2°F and 104°F).
- Charge only using the charger provided with the tool.
- Store your batteries in a cool dry place (5°C-20°C/41°F-68°F). Never store batteries in discharged state.
- It is better for Li-ion batteries to discharge and reload them regularly (at least 4 times a year). The ideal charge for long-term storage of your Li-ion battery is 40% of capacity.
- When disposing of batteries, follow the instructions given in the section “Protecting the environment”.
- Do not cause short circuits. If connection is made between the positive (+) and negative (-) terminal directly or via accidental contact with metallic objects, the battery is short circuited and an intense current will flow causing heat generation which may lead to casing rupture or fire.
- Do not heat. If batteries are heated to above 100°C (212°F), sealing and insulating separators and other polymer components may be damaged resulting in electrolyte leakage and/or internal short circuiting leading to heat generation causing rupture or file. Moreover do not dispose of the batteries in fire, explosion and/or intense burning may result.
- Under extreme conditions, battery leakage may occur. When you notice liquid on the battery, proceed as follows:
  - ✓ Carefully wipe the liquid off using a cloth. Avoid skin contact.
  - ✓ In case of skin or eye contact, follow the instructions below:
    - Immediately rinse with water. Neutralize with a mild acid such as lemon juice or vinegar.
    - In case of eye contact, rinse abundantly with clean water for at least 10 minutes. Consult a physician.









**Fire hazard! Avoid short-circuiting the contacts of a detached battery. Do not incinerate the battery.**

### Charger

Only use the model of charger recommended. See the technical data.

## Symbols

	Conforms to relevant safety standards
 	To reduce the risk of injury, the user must read and understand this manual before using this product.
	Wear ear protectors. Exposure to noise can cause hearing loss.
	Wear eye protection.
	Class II, double isolation(only for charger)
	Do not dispose of old appliances with domestic rubbish

## 3. YOUR PRODUCT

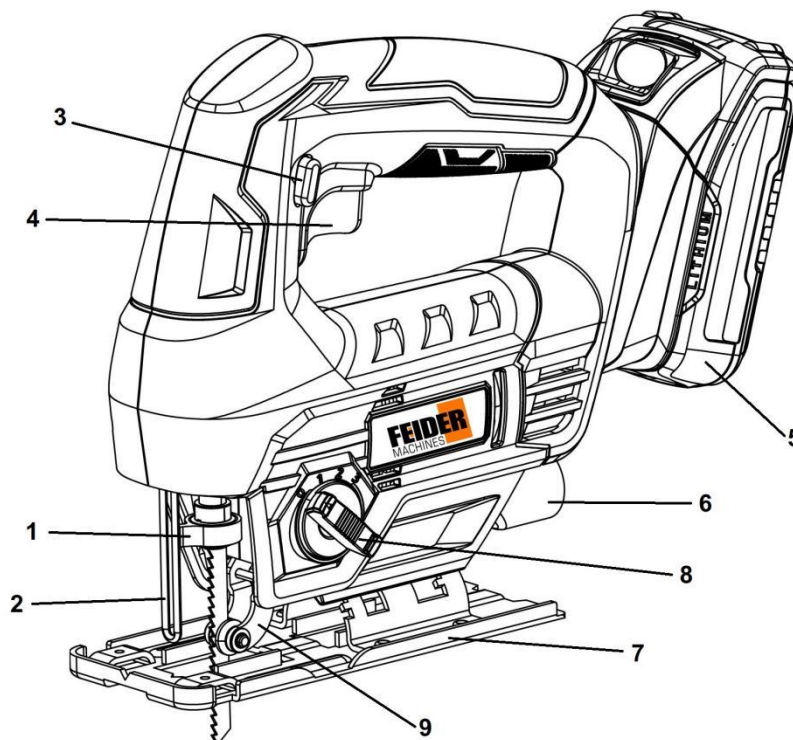

1. Quick-change blade clamping holder
2. Safety guard
3. Lock-off button
4. ON/OFF switch
5. Battery pack (deliver without)
6. Dust extraction outlet
7. Soleplate
8. Pendulum regulation control
9. Guide roller

## 4. PACKAGE CONTENT LIST

- Remove all packaging materials.
- Remove remaining packing and package inserts (if included).
- Check that the package contents are complete.
- Check the appliance, the power cord, the power plug and all accessories for transportation damage.
- Keep the packing materials as far as possible till the end of the warranty period. Dispose it into your local waste disposal system afterwards.



**WARNING: Packaging materials are not toys! Children must not play with plastic bags!**

### Danger of suffocation!

1x machine 1x manual

1x saw blade for wood

1x sawblade for metal

1x small allen wrench

If any parts are missing or damaged, please contact your dealer.

**Note: If any parts are missing or damaged, please contact your dealer.**

## 5. OPERATION

### 5.1 CHARGING THE BATTERY PACK

**NOTE: The battery and charger not delivered in package, you can buy Builder battery platform 1 which used for full range.**

- 1) Take the battery pack out of the equipment. Do this by pressing the side pushlock buttons.
- 2) Check that your mains voltage is the same as that marked on the rating plate of the battery charger. Insert the power plug of the charger into the socket outlet. The RED LED will then begin to light.
- 3) Insert the battery pack into the battery charger .then the red LED on charger will begin to Green flash light.
- 4) You will find a label with “Charger indicator” of the LED indicator on the charger.

The battery pack can become a little warm during the charging. This is normal.

If the battery pack fails to charge, check:

- Voltage at the power socket
- Whether there is good contact at the charging contacts.
- Whether the battery pack is warm or not, The battery protection system will not allow the battery to be charged if the battery temperature is over 40°C after use, allow the battery pack to cool to room temperature before commencing with the charging.

If the battery pack still fails to charge, send the charging unit and the battery pack to our customer service center.

To ensure that the battery pack provides long service, you should take care to recharge it promptly. You must recharge the battery pack when you notice that the power of the cordless vacuum drops. Never allow the battery pack to become fully discharged. This will cause it to develop a defect.

Battery capacity indicator

Press the switch for the battery capacity indicator . The battery capacity indicator shows the charge status of the battery using 4 LEDs as following:

All 4 LEDs are lit:

The battery is fully charged.

3 LED(s) are lit:

The battery has approx 75% remaining charge.







2 LED(s) are lit:

The battery has approx 50% remaining charge.

1 LED is lit:

The battery will be empty soon, please recharge the battery.

## 5.2 CHARGER INDICATOR

Indicator status	Explanations and actions
	Ready for use The charger is connected to the mains and is ready for use; there is no battery pack in the charger.
	Charging The charger is charging the battery pack in charge mode.
	Battery pack is full of charge. Charging is finished and battery pack in the charger.
	The temperature of battery is too high or too low, the charger is under protection status. The charging function can be recovered after the temperature is normal.
	Unrecoverable battery malfunction.

## 5.3 INSERTING AND REMOVING THE BATTERY



**WARNING:** Before making any adjustments ensure the drill is switched off with the direction of rotation selector in the center position

1. Remove the battery: press the battery release latch in and at the same time pull the battery pack off.
2. To insert the battery, push the battery pack onto the contacts of the tool.

## 5.4 ADJUSTING THE SOLEPLATE

- The soleplate (8) can be tilt adjusted 45° (left or right) in relation to the saw perpendicular to facilitate contour sawing.
- Loosen the two clamping screws (B) under the soleplate using the hexagon key (A) supplied with the tool, adjust the soleplate to the desired angle and re-tighten the screws (B).
- The angle can be set using a marked scale on top of the soleplate.
- This jig saw is equipped with four cutting actions, one straight and three orbital.
- Orbital action has a more aggressive blade motion and is designed for cutting in soft materials like wood or plastic.

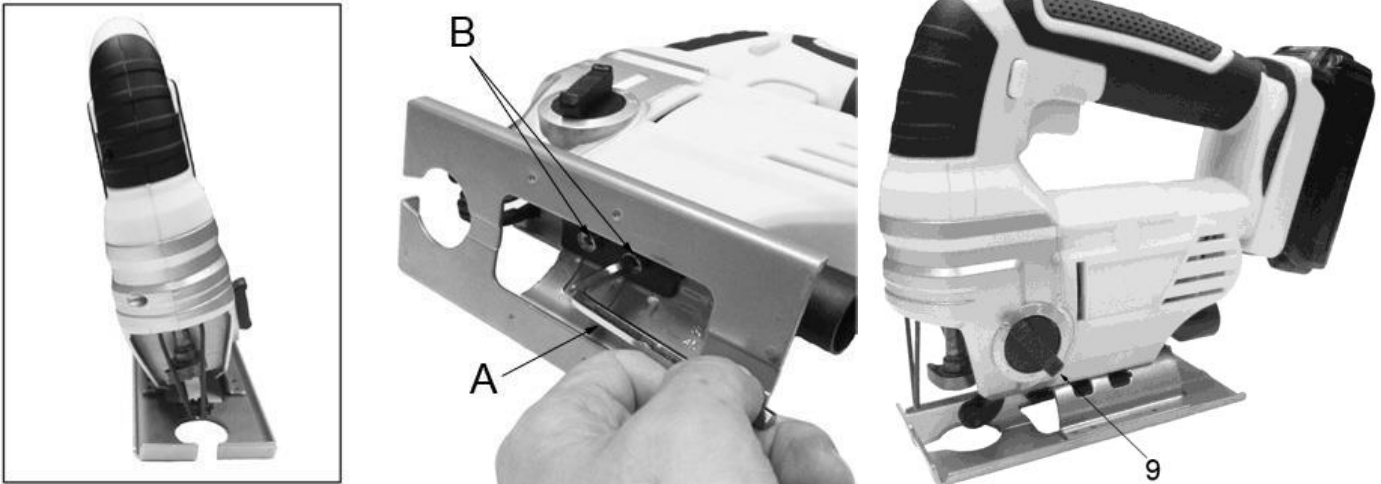

• Orbital action provides faster cut, but with a rougher cut across the material. In orbital action, the blade moves forward during the cutting stroke in addition to the up and down motion.

**Note:** Metal or hardwoods should never be cut in orbital action.

• To adjust the cutting action, moves the pendulum regulation control (9) between the four cutting positions: 0,1,2, and 3.

• Position 0 is the straight cutting.

• Positions 1, 2 and 3 are orbital cutting.

• The aggressiveness of the cut increase as the control is moved from one to three, with three being the most aggressive cut.

• Never use a blade unsuitable for the task and item to be cut.

Hold the saw in front of you with a firm grip on the handle.

• Ensure that the saw blade is not touching anything and that the power cable is not in the way when starting the saw.

Make sure that the item is clamped tight, and that the saw line is clearly marked. Connect the vacuum extractor nozzle to an extractor system where possible.

• Start the saw. Place the soleplate on the item, and let the saw blade touch the saw line.

• Saw, but do not place more pressure on the blade than is necessary. Avoid lateral pressure on the blade.

## 5.5 SAWING WOOD

• Check that the item does not contain nails or other metal objects. Always wear a mask.

## 5.6 SAWING METAL

• We recommend lubricating the material and saw blade with cutting oil to protect the tool and avoid overheating. Support the item securely with wooden blocks.



**Important! Check all screws on the saw regularly, particularly those that hold the blade. Tighten if required.**

## 6. CLEANING AND MAINTENANCE

### 6.1 CLEANING

- Keep the ventilation slots of the machine clean to prevent overheating of the engine.
- Regularly clean the machine housing with a soft cloth, preferably after each use.
- Keep the ventilation slots free from dust and dirt.
- If the dirt does not come off use a soft cloth moistened with soapy water.
- Never use solvents such as petrol, alcohol, ammonia water, etc. These solvents may damage the plastic parts.

### 6.2 MAINTENANCE

- Our machines have been designed to operate over a long period of time with a minimum of maintenance. Continuous satisfactory operation depends upon proper machine care and regular cleaning.

## 7. TECHNICAL DATA

Rated voltage	20 V d.c.	Connection type	T-shank
Rotation speed	0-2400/min	Quick change blades	Yes
LED worklight	Yes	Lock button	Yes
Pendular positions	4	Base material	Steel
Carbon brush motor	Yes	Battery connection	Slide-on
Adjustable base	Yes	Acoustic pressure level LpA	80.6 dB(A) K= 5 dB(A)
Stroke height	19 mm	Acoustic power level LwA	91.6 dB(A) K= 5 dB(A)
Cutting depth steel	6 mm	Vibration:	$a_{h,M}=7.272\text{m/s}^2$ , $K=1.5\text{m/s}^2$ ;
Cutting depth wood	26 mm	Battery pack	Recommendation of battery to use: Model: FBA20U2 or FBA20U4 20V d.c. 2Ah or 4Ah
Cutting depth plastic	19 mm	Charger	Recommendation of charger to use: Model: FFC20EU Input 220-240V~ 50/60Hz, 0.6A max Output 20V d.c., 2A

#### Information

- The declared vibration total value has been measured in accordance with a standard test method and may be used for comparing one tool with another;
- The declared vibration total value may also be used in a preliminary assessment of exposure.

#### Warning

- that the vibration emission during actual use of the power tool can differ from the declared total value depending on the ways in which the tool is used;
- of the need to identify safety measures to protect the operator that are based on an estimation of exposure in the actual conditions of use (taking account of all parts of the operating cycle such as the times when the tool is switched off and when it is running idle in addition to the trigger time).
- Wear hearing protection

## 8. DISPOSAL



Electrical products should not be discarded with household products. According to the European Directive 2012/19/EU on waste electrical and electronic equipment and its implementation into national law, electrical products used must be collected separately and disposed of at collection points provided for this purpose. Talk with your local authorities or dealer for advice on recycling.

## 9. DELARATION OF CONFORMITY



### BUILDER SAS

32, rue Aristide Bergès - ZI 31270 Cugnaux - France,

declares that,

Product: Cordless Jigsaw 20V

Trade mark: Feider

Model: FSS20V-A

Serial number: **20211003969-20211004468**

is in conformity with the essential requirements and other relevant provisions of the applicable European Directives, based on the application of European harmonized standards. Any unauthorized modification of the apparatus voids this declaration.

European Directives (including, if applicable, their amendments up to the date of signature):

Rohs Directive (EU) 2015/863 amending 2011/65 / EU

“Machine” directive 2006/42 / EC

EMC Directive 2014/30 / EC

European harmonized standards (including, if applicable, their amendments up to the date of signature):

EN62841-1: 2015

EN62841-2-11: 2016

EN55014-1: 2017

EN55014-2: 2015

Cugnaux, 15/09/2021

Philippe MARIE / PDG

**Responsible of the technical file: Mr Olivier Patriarca**

## 10. WARRANTY



### WARRANTY

The manufacturer guarantees the product against defects in material and workmanship for a period of 2 years from the date of the original purchase. The warranty only applies if the product is for household use. The warranty does not cover breakdowns due to normal wear and tear.

The manufacturer agrees to replace parts identified as defective by the designated distributor. The manufacturer does not accept responsibility for the replacement of the machine, in whole or in part, and/or ensuing damage.

**The warranty does not cover breakdowns due to:**

- insufficient maintenance.
- abnormal assembly, adjustment or operations of the product.
- parts subject to normal wear and tear.

**The warranty does not extend to:**

- shipping and packaging costs.
- using the tool for a purpose other than that for which it was designed.
- the use and maintenance of the machine done in a manner not described in the user manual.

Due to our policy of continuous product improvement, we reserve the right to alter or change specifications without notice. Consequently, the product may be different from the information contained therein, but a modification will be undertaken without notice if it is recognized as an improvement of the preceding characteristic.

**READ THE MANUAL CAREFULLY BEFORE USING THE MACHINE.**

When ordering spare parts, please indicate the part number or code, you can find this in the spare parts list in this manual. Keep the purchase receipt; without it, the warranty is invalid. To help you with your product, we invite you to contact us by phone or via our website:

- **+33 (0)9.70.75.30.30**
- **<https://services.swap-europe.com/contact>**

You must create a "ticket" via the web platform.

- Register or create your account.
- Indicate the reference of the tool.
- Choose the subject of your request.
- Describe your problem.
- Attach these files: invoice or sales receipt, photo of the identification plate (serial number), photo of the part you need (for example: pins on the transformer plug which are broken).



# 11. PRODUCT FAILURE

## WHAT TO DO IF MY MACHINE BREAKS DOWN?

### If you bought your product in a store:

- a) Empty the fuel tank if your product has one.
- b) Make sure that your machine is complete with all accessories supplied, and clean! If this is not the case, the repairer will refuse the machine.

Go to the store with the complete machine and with the receipt or invoice.

### If you bought your product on a website:

- a) Empty the fuel tank if your product has one.
- b) Make sure that your machine is complete with all accessories supplied, and clean! If this is not the case, the repairer will refuse the machine.
- c) Create a SWAP-Europe service ticket on the site: <https://services.swap-europe.com> When making the request on SWAP-Europe, you must attach the invoice and the photo of the nameplate (serial number).
- d) Contact the repair station to make sure it is available before dropping of the machine.

Go to the repair station with the complete machine packed, accompanied by the purchase invoice and the station support sheet downloadable after the service request is completed on the SWAP-Europe site

For machines with engine failure from manufacturers BRIGGS & STRATTON, HONDA and RATO, please refer to the following instructions.

Repairs will be done by approved engine manufacturers of these manufacturers, see their site:

- <http://www.briggsandstratton.com/eu/fr>
- <http://www.honda-engines-eu.com/fr/service-network-page;jsessionid=5EE8456CF39CD572AA2AEEDFD290CDAE>
- <https://www.rato-europe.com/it/service-network>

**Please keep your original packaging to allow for after-sales service returns or pack your machine with a similar cardboard box of the same dimensions.**

**For any question concerning our after-sales service you can make a request on our website <https://services.swap-europe.com>**

**Our hotline remains available at +33 (9) 70 75 30 30.**



# 12. WARRANTY EXCLUSIONS

## THE WARRANTY DOES NOT COVER:

- Start-up and setting up of the product.
- Damage resulting from normal wear and tear of the product.
- Damage resulting from improper use of the product.
- Damage resulting from assembly or start-up not in accordance with the user manual.
- Breakdowns related to carburetion beyond 90 days and fouling of carburetors.
- Periodic and standard maintenance events.
- Actions of modification and dismantling that directly void the warranty.
- Products whose original authentication marking (brand, serial number) has been degraded, altered or withdrawn.
- Replacement of consumables.
- The use of non-original parts.
- Breakage of parts following impacts or projections.
- Accessories breakdowns.
- Defects and their consequences linked to any external cause.
- Loss of components and loss due to insufficient screwing.
- Cutting components and any damage related to the loosening of parts.
- Overload or overheating.
- Poor power supply quality: faulty voltage, voltage error, etc.
- Damages resulting from the deprivation of enjoyment of the product during the time necessary for repairs and more generally the costs related to the immobilization of the product.
- The costs of a second opinion established by a third party following an estimate by a SWAP-Europe repair station
- The use of a product which would show a defect or a breakage which was not the subject of an immediate report and/or repair with the services of SWAP-Europe.
- Deterioration linked to transport and storage\*.
- Launchers beyond 90 days.
- Oil, petrol, grease.
- Damages related to the use of non-compliant fuels or lubricants.

\* In accordance with transport legislation, damage related to transport must be declared to carriers within 48 hours maximum after observation by registered letter with acknowledgement of receipt.

This document is a supplement to your notice, a non-exhaustive list.

**Attention:** all orders must be checked in the presence of the delivery person. In case of refusal by the delivery person, it you must simply refuse the delivery and notify your refusal.

**Reminder:** the reserves do not exclude the notification by registered letter with acknowledgement within 72 hours.

### Information:

Thermal devices must be wintered each season (service available on the SWAP-Europe site). Batteries must be charged before being stored.



BUILDER SAS  
32, rue Aristide Bergès - ZI 31270 Cugnaux - France  
MADE IN PRC