

FEIDER



PETROL BRUSH CUTTER & GRASS TRIMMER

FDBT314T-B

USER GUIDE

CAUTION: Read this manual before using this machine!

CONTENTS

1. SAFETY INSTRUCTIONS.....	3
2. YOUR PRODUCT.....	7
3. ASSEMBLY.....	10
4. FILLING FUEL TANK AND OIL TANK.....	13
5. OPERATION.....	15
6. MAINTENANCE AND STORAGE.....	17
7. TROUBLE SHOOTING.....	18
8. DECLARATION OF CONFORMITY.....	19
9. WARRANTY.....	20
10. PRODUCT FAILURE.....	21
11. WARRANTY EXCLUSIONS.....	22

1. SAFETY INSTRUCTIONS

- WARNING! When using this type of tool, basic precautions should always be followed to reduce the risk of fire and injury.
- Read all instructions carefully before attempting to use this product and retain these instructions. Be familiar with all the operations described in these operating instructions. This product must be operated by experienced users.
- Inexperienced users shall first have training in all operations with a professional.
- If you are giving this machine to others, please also provide them with this instructions manual.
- Read all markings affixed on the product (symbols, stickers, technical data, etc.). The symbols are explained in this manual.
- Use this machine as described in this instruction manual. It is strictly forbidden to use this tool for applications other than those described in this manual.
- Failure to follow these instructions can result serious injuries and, in some cases, death.
- This product is intended for private domestic use only. Do not use it for commercial purposes.
- Never let people unfamiliar with these instructions or children use this product.
- National regulations may limit the use of the machine.
- People under the age of 18 must not use this product.
- Keep in mind that the operator or user is responsible for accidents or risks to other persons or their property.
- WARNING: Do not use of the unit when tired, ill or under the influence of alcohol or other drugs.
- Do not use the tool if you are not in an adequate physical condition.
- This tool is intended for outdoor use. Never use it indoors.
- Secure the machine during transport to prevent loss of fuel, damage or injury; always install the protection device on the blade, check the cap of the fuel tank, and do not transport the tool upside down. Always transport the tool with its handle.
- Keep people and animals away from the work area. Children and people who do not know how to use this tool should not touch it and handle it.
- WARNING: Keep people at least 15 m from the machine during operation.
- Use the product only under daylight or under good artificial light.
- When using the machine, always wear full protective equipment including a protective helmet, protective mask, hearing protection, ocular protection, gloves, slip-resistant foot protection and protective clothing. The protective equipment shall be in conformity with the European norms.
- Wear appropriate clothing. Do not wear loose or unbuttoned clothes. Do not wear jewellery that may come in contact with moving parts. If you have long hair, tie them down and wear an appropriate safety helmet.
- Do not operate the product with damaged guards or shields not in place.
- Keep hands and feet far away from the cutting parts at all times and especially when switching ON/OFF the tool.
- Do not use the tool in an area where ventilation is poor. Gas emissions can cause injury.
- Do not work when it rains and in bad weather. Do not use the tool in damp locations.
- Do not use the tool in the presence of flammable liquids or gases.
- Keep the work area clear. Before working, inspect the work area and remove any materials or objects that could cause accidents.
- Do not force the tool.
- Use only accessories and guards supplied or recommended by the manufacturer. The use of non-recommended accessories (e.g. metal multi-piece pivoting chains and flail blades) may result an accident. Ask your dealer for advice.

- Keep firm footing and balance during operation. Always use the harness provided.
- Have a correct working posture; stay stand, do not lean. The working positions should be changed regularly.
- Always inspect the machine before and after operation. If the tool is damaged or faulty, stop using the tool and bring it to an authorized service for inspection and repair.
- Be concentrated when using the tool. Look at what you do, make sense and do not use the tool when you are tired.
- Remove the blade guard before using the tool.
- A damaged part must be properly repaired or replaced by an authorized service center, unless otherwise specified in this instruction manual.
- Do not use the tool if the switch is not working (if it cannot be turned ON or OFF).
- Immediately stop the tool in the event of a malfunction of the motor or in case of unusual noise.
- Do not use the tool if the starter is damaged.
- Avoid any contact with the cutting attachment during operation; they can cause severe cuts.
- When not in use, the machine must be stored in a dry, locked place out of the reach of children.
- Before using the tool and after any impact, please check for signs of wear or if it is not damaged. If repairs are required, they should be done by a qualified service.
- Always switch off the machine:
 - Every time you leave it unattended;
 - Before inspection and maintenance
 - After hitting a foreign object;
 - When abnormal vibration occurs;
 - During the replacement of parts.
- Do not use the product on a slippery surface.
- Do not use the product on steep, slippery slopes.
- When planning your work schedule, allow enough time for rest. Limit continuous use of the tool. For example, do 30 ~ 40 minute sessions interspersed with a 10 ~ 20 minute break. Work a maximum of two hours a day.
- If the machine has struck foreign objects, check if the tool is damaged and bring it to repair if necessary.
- Keep handles dry, clean and free of oil and grease. Oily, greasy grips are slippery and cause loss of control.
- Be careful when using the machine during stormy weather. Do not use the machine during lightning and thunderstorms.
- Warning - When operating the tool, be careful of the emission of exhaust gases, avoid to be exposed to these and wear protective equipment.
- For machines with a clutch, check regularly that the cutting attachment stops turning when the engine idles.
- Check the tool before and after use. Check for loose fasteners, fuel leaks and damaged parts, such as cracks in the cutting attachment. If the tool is damaged, if parts are missed or meet some dysfunctions, do not use the tool and bring it to a service agent for inspection and reparation.
- Check the tool after dropping or other impacts to identify any significant defects; if any defects are observed, stop to use the tool and bring it to a service agent for inspection and reparation.
- Do not store in a closed area where fuel vapors can reach an open flame from hot water heaters, furnaces, etc. Store in a locked, well-ventilated area only.
- Never place the machine in any places where there are flammable materials (dry grass, etc.), combustible gasses or combustible liquids.

- When the machine is placed in storage for a long time, drain fuel from the fuel tank and carburetor, clean the parts, move the machine to a safe place and confirm that the engine is cooled down.

Fuel Handling

- Be very careful when handling fuels. They are flammable and the vapors are explosive.
- Use only an approved container.
- Never remove the fuel cap or add fuel while the machine is on. Turn off the unit and allow the engine and exhaust components to cool before refueling.
- Do not smoke.
- Never refuel inside a room.
- Never store the tool and the fuel tray indoors where there is a naked flame, such as near a water heater.
- If fuel has spilled, do not attempt to start the machine, but rather move it away from the spill before starting to use it. Clean any spills.
- Replace and tighten the fuel tank cap after refueling.
- Follow the instructions in this manual for filling the tool with fuel.

Maintenance and storage

- Stop the tool and wait until it stops. Make sure all moving parts have come to a standstill.
- Allow the machine to cool before performing inspection, adjustments, maintenance, servicing and storage.
- Maintenance and cleaning shall always be done after operation. Follow the instructions given in this manual for maintenance, cleaning and storage.
- Store the tool where fuel vapors will not reach a flame or spark.
- During transport, maintenance and storage, always install the cover on the metal blade.
- When the machine is stored for a long period of time, drain the fuel tank and clean the parts. Place the machine in a safe place.
- Cleaning and maintenance before storage.

Kickback and related warnings

Kickback is a sudden reaction to a pinched or snagged rotating wheel, backing pad, brush or any other accessory. Pinching or snagging causes rapid stalling of the rotating accessory which in turn causes the uncontrolled power tool to be forced in the direction opposite of the accessory's rotation at the point of the binding.

For example, if a cutting attachment is snagged or pinched by the workpiece, the edge of the wheel that is entering into the pinch point can dig into the surface of the material causing the wheel to climb out or kick out. The wheel may either jump toward or away from the operator, depending on direction of the wheel's movement at the point of pinching. Abrasive wheels may also break under these conditions.

Kickback is the result of power tool misuse and/or incorrect operating procedures or conditions and can be avoided by taking proper precautions as given below:

- Never place your hand near the rotating accessory. Accessory may kickback over your hand.
- Do not position your body in the area where power tool will move if kickback occurs. Kickback will propel the tool in direction opposite to the wheel's movement at the point of snagging.
- Use special care when working corners, sharp edges etc. Avoid bouncing and snagging the accessory. Corners, sharp edges or bouncing have a tendency to snag the rotating accessory and cause loss of control or kickback.

Residual risks







Even if you use this product in accordance with all safety requirements, the potential risk of injury and damage remains. The following hazards may arise:









- There are harmful health consequences resulting from the emission of vibrations if the product is used for long periods of time or not managed adequately and properly maintained. The vibrations can produce the so-called "white finger" disease. If any of the symptoms of "white finger" syndrome appear, see a doctor immediately. Symptoms of the "white finger" include: numbness, loss of sensitivity, tickling, tingling, pain, loss of strength, color changes, or skin condition. These symptoms usually appear on the fingers, hands or wrists. The risk increases at low temperatures. To reduce this risk, please wear gloves and keep your hands warm. Limit the operating time.
- There is a risk of hearing loss during prolonged use, in particular if you do not wear hearing protection. Always wear hearing protection and limit the operating time.
- Cuts if no suitable protective clothing is worn.
- Inhalation of particles and exhaust gases if a mask of protection is not worn.
- Contact with projected objects.
- Burns when touching with hot surfaces.

Intended use

This machine can be used with the cutting wire as a trimmer for cutting grass and weeds of small thickness and in small quantity and with the cutting blade as a brush cutter for cutting denser vegetation. This machine must not be used for cutting or other cutting operations where the cutting tool must be lifted above the ground. This machine is only authorized for private use. Any other use or modification of this machine is prohibited and involves high risks.

Explanation of symbols

	Warning symbol.
	Read instructions manual.
	Wear protective equipment: hearing protection, eye protection, and helmet.
	Wear protection gloves.
	Wear protective footwear.
	Caution to exhaust gases.
	Do not smoke and do not use the tool near naked flame.

	The accessible part are hot when operate the tool.
	Caution! Risk of rebound. Beware of thrown objects
	Keep bystanders away at least 15m.
	Caution! The tool can contact to a voluminous material. Loss of control and injuries can be created. Beware of blade thrust.
	Cutting attachment(Brush cutter) speed.
	Cutting attachment(Grass trimmer) speed.
	Guarantee sound power level
	Be careful of the cutting attachment!

2. YOUR PRODUCT

a. Description

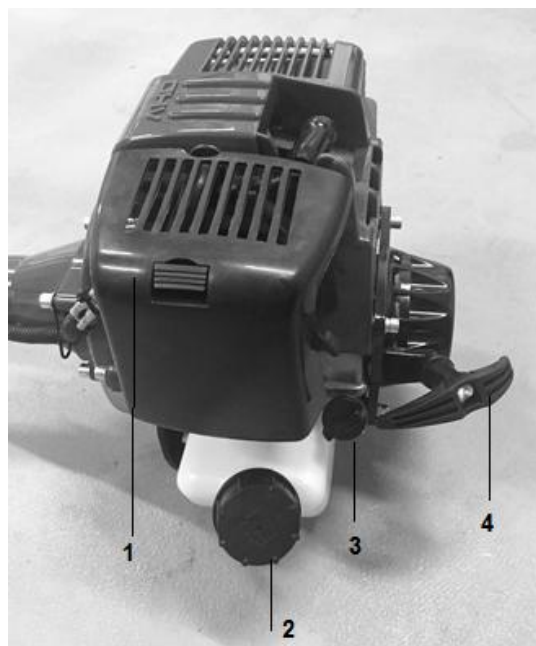

1. Air filter
2. Fuel tank
3. Oil tank
4. Recoil starter

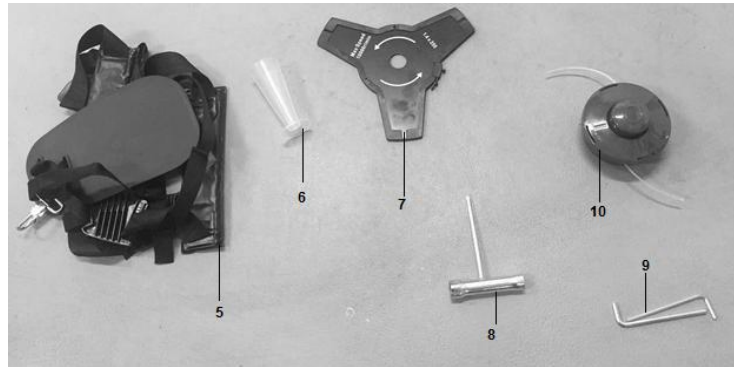

5. Harness
6. Oil cup
7. 3 teeth blade
8. Wrench
9. Metal lock pin/ wrench
10. Nylon cutting head

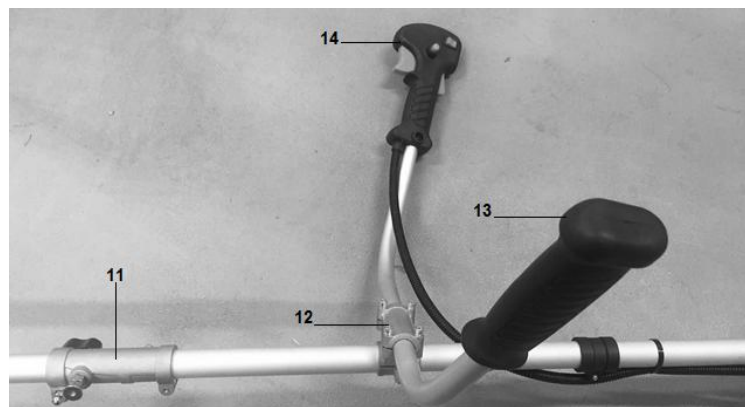

11. Bar assembly
12. Bracket (handle part support)
13. Handle
14. Handle with throttle trigger, ON/OFF switch and throttle trigger lockout

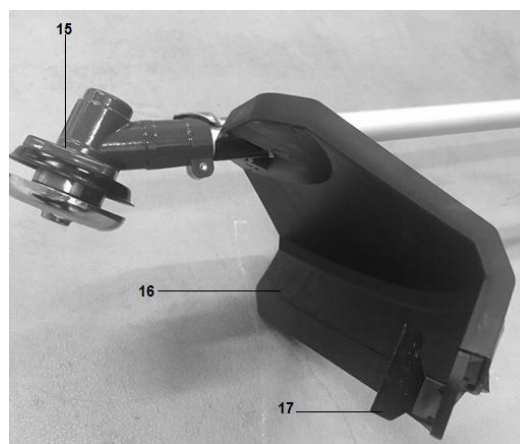

15. Angle drive
16. Carter of protection
17. Cutting line device

b. Technical data

Engine displacement	31cm ³
Maximum engine speed	Brush cutter: 9300min ⁻¹ Grass trimmer: 8000min ⁻¹
Maximum power	0,7kW
Mass	Empty tank: 7,3kg Empty tank with specified attachment: 8kg Full tank and specified attachment: 8,5kg
Volume of fuel tank	0,7l
Volume of oil tank	0,08l
Cutting diameter	Grass trimmer: 480mm Brushcutter: 255mm
Cutting thickness	Brushcutter: 1,4mm (metal blade) Grass trimmer: 2,4mm (non-metallic flexible line)
Cutting teeth	Brushcutter: single piece (three teeth metal) Grass trimmer: 2 lines (non-metallic flexible line)
Blade center hole diameter	25,4mm (metal blade)
Maximum rotational frequency of the spindle	Brushcutter: 7000min ⁻¹ Grass trimmer: 6000min ⁻¹
Cutting blade	JINLIFU, 10000/min (1.4X255)
Cutting string head	ROYAL, 10000/min
Gear ratio	4:3
Engine	139F ROYAL
Engine idle speed	3100±400min ⁻¹
Clutch engagement speed	4500min ⁻¹
Measured vibration emission value	Brush cutter: - Left handle: 7,06m/s ² - Right handle: 6,87m/s ² K=1.5 m/s ² Grass trimmer: - Left handle: 6,86 m/s ² - Right handle: 6,67 m/s ² , K=1.5 m/s ²
Measured sound pressure level LpA dB(A)	Brush cutter: 91,5dB(A) K= 3dB(A) Grass trimmer: 93.1dB(A) K= 3dB(A)
Measured sound power level LwA dB(A)	Brush cutter: 104 dB(A) K= 3dB(A) Grass trimmer: 106,5dB(A) K= 3dB(A)
Guaranteed sound power level	113dB(A)

3. ASSEMBLY

a) Installation of the tube on the tool

- Unscrew the bolt (1) and remove the screw cap (2). See Fig 1.
- Insert the attachment into the connector (Fig 2).
- Make sure to fix the pin into the hole of the tube. Put back the screw cap (2) and screw the bolt on it (3). See Fig 3.

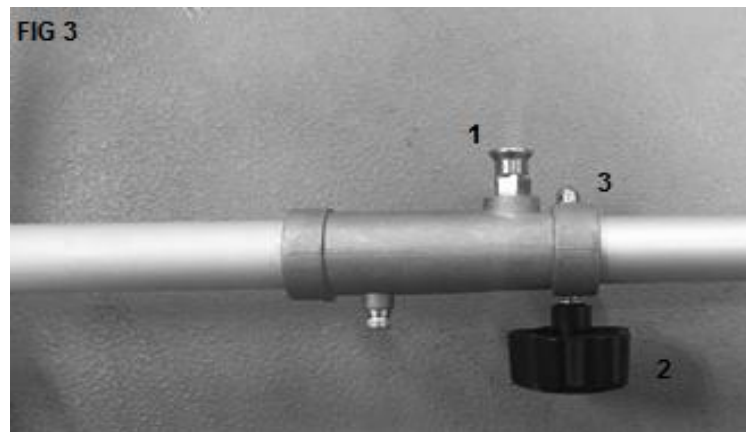
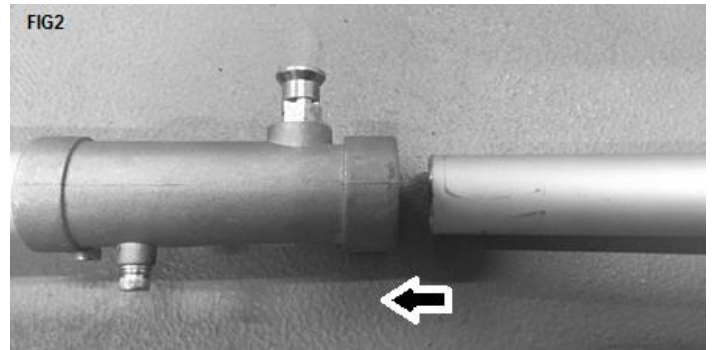
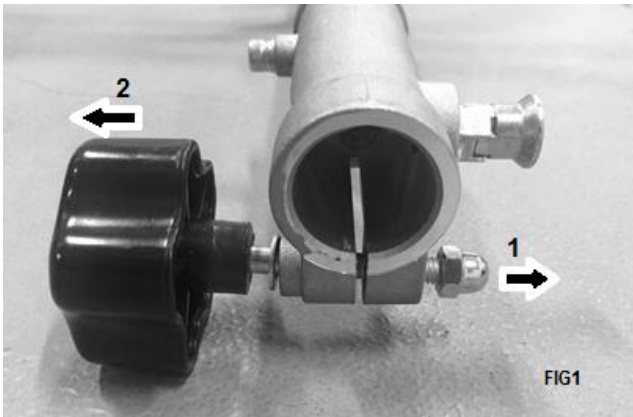

b) Installation of the handle

- Unscrew the bracket and remove it (Fig 4)
- Install the handle in the bracket at the desired position (Fig 5).
- Reinstall the bracket and screw it with the 4 screws (Fig 6).

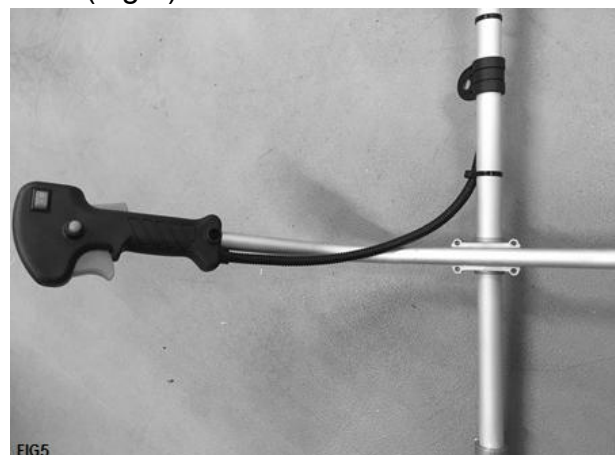
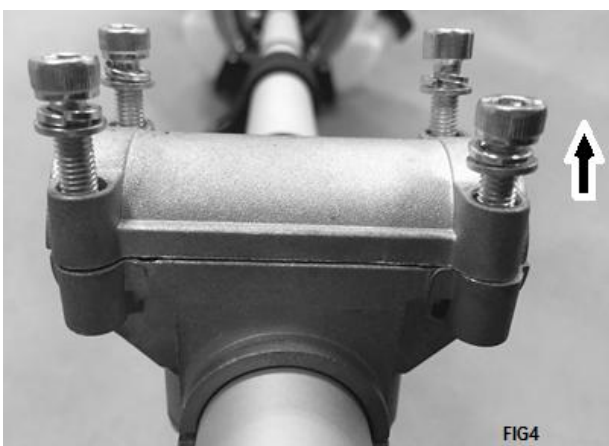

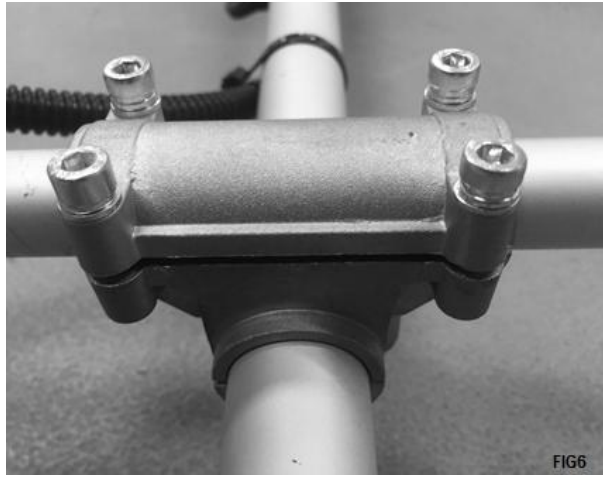

c) Installation of the carter of protection

- Remove the screws which are on the carter of protection (fig7).
- Install the tube on the carter of protection. Make sure that you have installed it in the correct position (Fig 8).
- Screw the carter on the tube with the two screws (Fig 9).

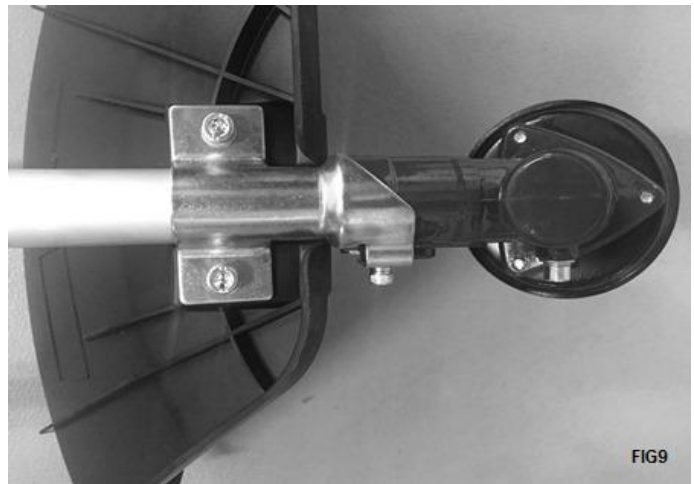
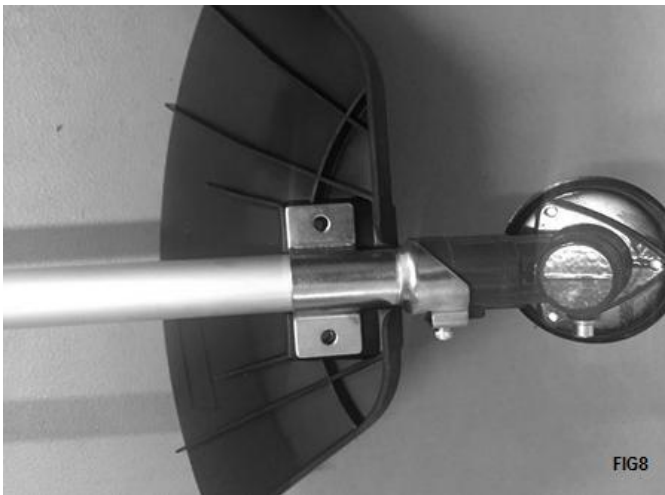
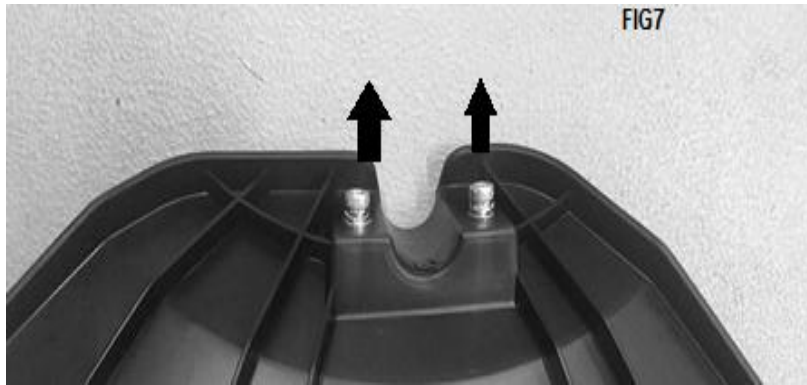

d) Installation of the nylon cutting head (for grass trimmer operation)

- Insert a metal locking tool into the hole on the side of the drive gear and on the tool drive (Fig 10).
- Remove cover bell and the holding nut from the shaft (Fig 11).
- Install and screw the nylon cutting head. Make that it is well installed.
- Remove then the metal locking tool.

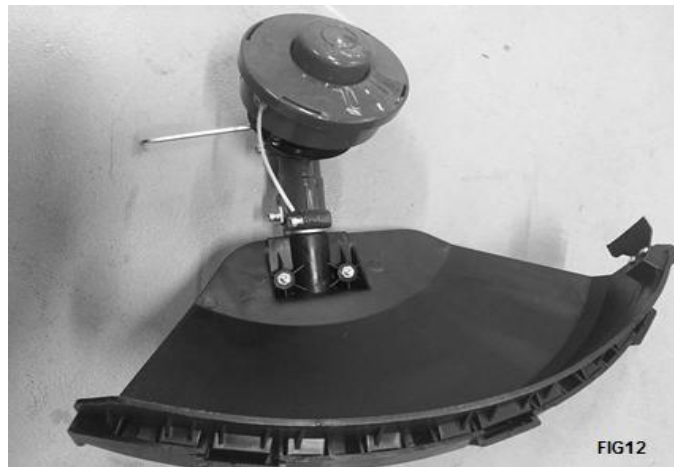
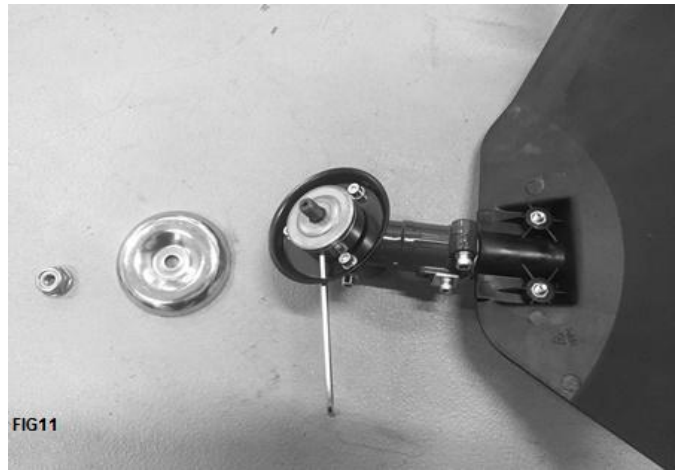
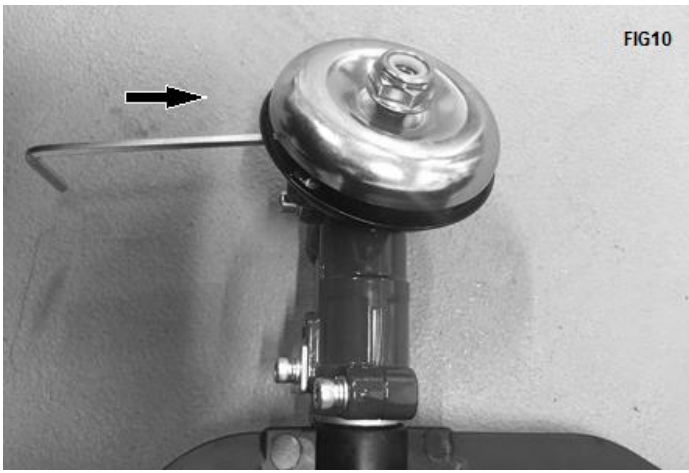

e) Installation of metal blade (for brush cutter operation)

- Insert a metal locking tool into the hole on the side of the drive gear and on the tool drive (Fig 10).
- Remove cover bell and the holding nut from the shaft (Fig 11).
- Install, in the following order, on the shaft: the blade, the cover bell and then the holding nut (Fig 13).
- Remove the metal locking tool.
- Warning: beware of sharp edges. Always wear gloves.

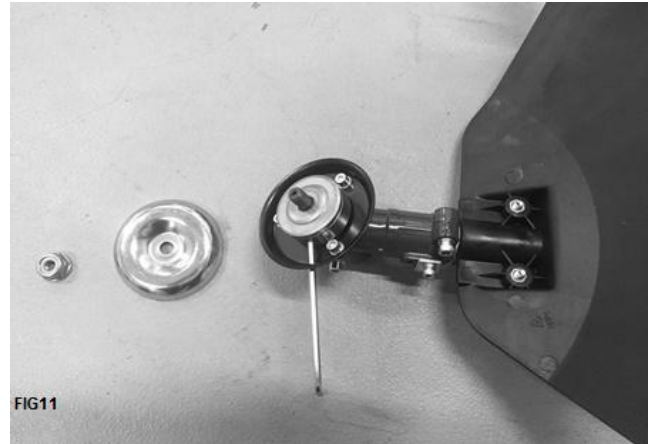
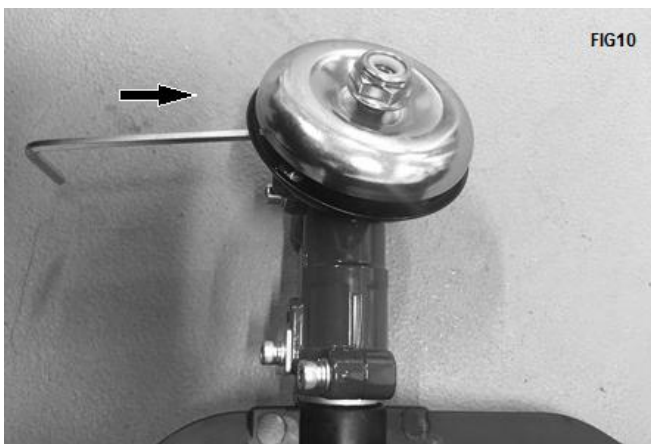



FIG13

NOTE:

After installation, always check if the installation is correct. If blade is not well installed, it will vibrate excessively and can cause injury. When operation, if there is abnormal vibration, immediately stop the tool and check the installation.

4. FILLING FUEL TANK AND OIL TANK

a) Fuel

- **Warning: Gasoline is highly flammable. Keep the fuel in specially designed cans.**
- **Only fill the tank outside and do not smoke during the operation. Avoid sparks or open flames near the fuel.**
- **Fill the tank before starting the engine. Never remove the fuel tank cap, add fuel while the engine is still running, or while the engine is still warm.**
- **Avoid overfilling the tank: When excess fuel has escaped, do not attempt to start the engine, but move the machine away and avoid any sources of ignition in the vicinity until the fuel vapors have dissipated.**
- **Fully tighten all fuel filler caps and cans.**
- **Fill the tank on the floor.**
- **The engine must be started at a distance of at least 3 meters from where the fuel tank has been filled.**
- **Switch off the engine before adding fuel. Shake the mixture thoroughly before filling the tank.**
- **Store gasoline in tanks specially designed for this purpose.**
- **Fill the fuel tank of your appliance outdoors and avoid smoking during work.**
- **Fill the tank before starting the engine. Never open the fuel tank cap or fill fuel tank while the engine is running or the engine is still hot.**
- **Avoid spilling gasoline: When gasoline is spilled, do not start the machine and move it away from where the gasoline has spilled to avoid possible sources of fire.**
- **Screw all caps and tank cover carefully.**

This type of tool is designed to be used with unleaded gasoline. Using unleaded gasoline prevents unnecessary pollution in the interests of your health and the protection of the environment. Using gasoline or oil of lesser quality can damage seal rings, ducts or fuel tank.

Exhaust emissions are regulated by the basic technical characteristics of the engine and its components (carburation, adjustment of spark plugs, control of exhaust opening and closing times) in the absence of accessories or a catalyst during combustion.

Filling the tank

- Unscrew the tank cap.
- Fill the tank to 80% of its capacity.

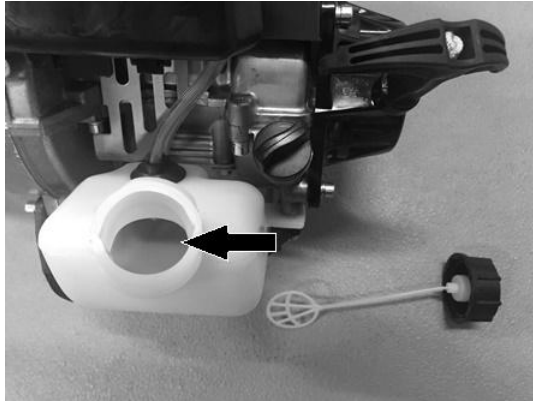

- Screw the fuel cap back on. Clean the fuel tank cap and the area around after filling the fuel tank. Eliminate overflow of fuel mixture by rubbing.

b) Oil

- Open the oil tank.
- By using the provided container, pour the oil in the tank. Do not overfill.

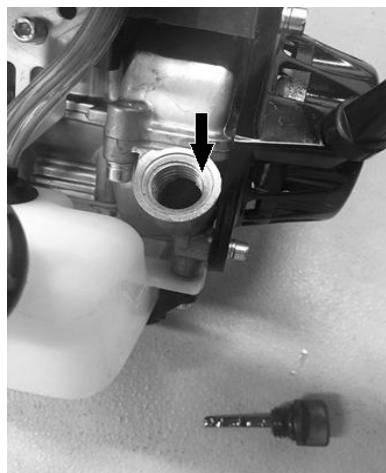

- Close the tank. Wipe off all overflow oil.

Information

Recommended oil: We recommend the use of high quality detergent oil classified for SF, SG, SH, SJ or higher. Do not use special additives.

External temperatures determine the correct oil viscosity for the engine.

Below 4°C, the use of SAE 30 oil causes difficult start-ups.

Above 27°C, the use of 10W-30 oil can increase the oil consumption. Check the oil level regularly.

Checking the oil level

- The tool must be switch off.
- Remove the dipstick from the oil tank and wipe it off.
- Insert the oil tank dipstick into the tank, without screwing it in, and then remove it to check the oil level.
- If the oil level is near or below the lower limit of the dipstick, remove the dipstick and refill the oil tank until the upper limit of the dipstick (bottom edge of the dipstick). Do not overfill.



Replace the oil tank dipstick.

5. OPERATION

a) Starting the tool

- Move the ON/OFF switch to “ON” position (I).



- Pull the recoil starter until engine starts.
- For the operation, push and hold the throttle trigger lockout (1) and then push the throttle trigger (2).



b) Stopping the tool

- Release the throttle trigger and the throttle trigger lockout.
- Move the ON/OFF switch to STOP position (O).



c) Grass trimmer operation

- Trimming

Tilt the head slowly to direct debris away from you. If cutting up to a barrier such as fence, wall or tree, approach from an angle where any debris ricocheting off the barrier will fly away from you, Move the line head slowly until the grass is cut right up the barrier, but do not jam (overfeed) the line into the barrier. If trimming up to a wire mesh or chain linked fence be careful to feed only up to wire. If you go too far the line will snap off around the wire. Trimming can be done to cut through weed stems one at a time. Place the trimmer line head near the bottom of the weed-never high up which could cause the weed to chatter and catch the line. Rather than cut the weed right through, just use the very end of the line to wear through the stem slowly.

- **Scalping and edging**

Both of these are done with the line head tilted at a steep angle Scalping is removing top growth leaving the earth bare.

Edging is trimming the grass back where it has spread over a sidewalk or drive way. During both edging and scalping, hold the unit a steep angle and in a position where the debris, and any dislodging dirt and stones, will not come back towards you even if it ricochets off the hard surface. Although the picture shows how to edge and scalp every operator must find for himself the angles which suits his body size and cutting situation.

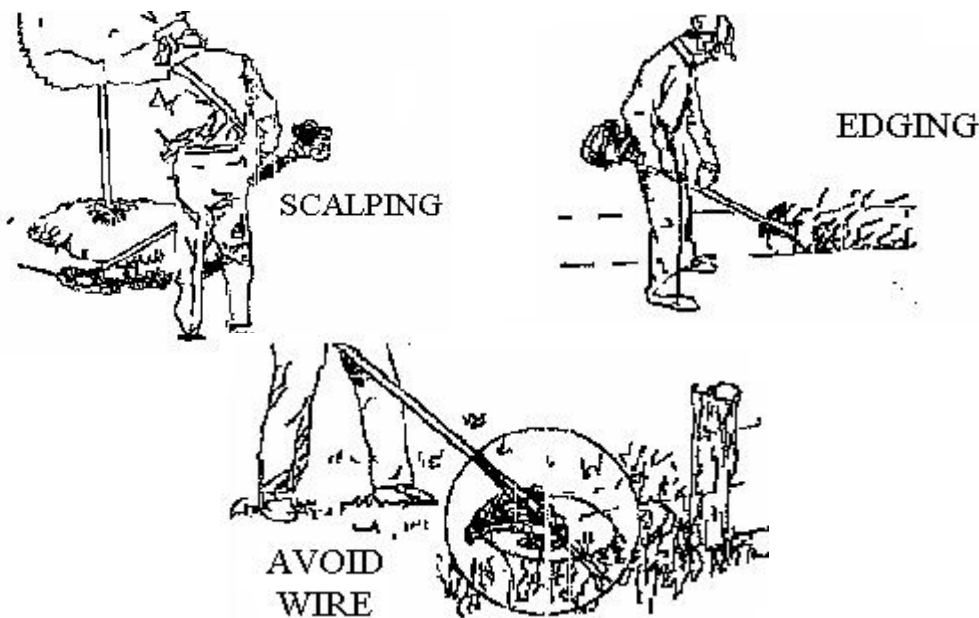

d) **Brushcutter operation**

- Do not use the brushcutter for cutting trees
- Do not cut with dull, cracked or damaged metal blade.
- Before cutting growth, inspect for obstructions such as boulders, metal stakes or strands of wire from broken fences. If an obstruction cannot be removed, mark its location so that you can avoid it with the blade. Rocks and metal will dull or damage a blade. Wire can catch on the blade head and flap around or be thrown into the air.
- Use the shoulder harness at all times adjust both harness and harness clamp on the unit so that the unit hangs a few inches above ground level. The cutting head and the debris shield should be level in all directions. Harness the unit on the right side of your body.
- Cut only with the side of the blade that the debris is moving away from you.
- If kickback occurs, the blade may be dull, or the material so thick and hard that you should use other tool instead of this machine.
- Do not force the blade to cut. Do not change the angle of cut after into the wood. Avoid using any pressure or leverage which could cause the blade to bind or crack.

Scything weeds

This is cutting by swinging the blade in a level arc. It can quickly clear areas of field grass and weeds. Scything should not be used to cut large, tough weeds or woody growths.

Scything can be done in both directions, or just in one way which results in the debris being thrown away from you.

That is using the side of the blade that it is rotating away from you. Tilt down the blade slightly on this same side. You will be hit by some debris if you scythe in both directions.

Cut exclusively with the side of the blade that allows waste to be thrown away from you.

If the blade bounces back, it may become blunt. If the blade is blunt or damaged, do not use the device.

Do not force the blade to cut. Do not change the cutting angle after cutting wood. Avoid pressing or using a lever that could bend or crack the blade.

6. MAINTENANCE AND STORAGE

Before any maintenance work, the machine must be switched off and completely cooled.

Maintenance shall be provided regularly and must be done according to the instructions provided in this instruction manual. A clean, well-maintained machine increases its lifetime and efficiency.

Improper maintenance can cause damage, accidents and render the tool inoperable in the short term.

Any other maintenance, modification or repair must be carried out by a qualified professional.

Do not immerse the tool in water or any other liquid.

a) Air filter

- Accumulated dust in the air filter will reduce engine efficiency. Increase fuel consumption and allow abrasive particles to pass into the engine. Remove the air filter as often as necessary to maintain in a clean condition. Light surface dust can readily be removed by tapping the filter. Heavy deposits should be washed out in suitable solvent.
- To clean the filter, remove filter cover and pull out the filter.

b) Adjusting the carburetor

Do not adjust carburetor unless necessary. If you have trouble with the carburetor, see your dealer. Improper adjustment may cause engine damage and void warranty.

c) Fuel filter

Fuel tank is fitted with a filter. Filter is situated at the free end of fuel pipe and can be picked out through fuel port with a piece of hooked wire. Check the fuel filter periodically. Do not allow dust to enter into fuel tank. Clogged filter will cause difficulty in starting engine or abnormalities in starting engine or abnormalities in engine performance.

When filter is dirty, replace the filter. When the inside of the fuel tank is dirty, it can be cleaned by rinsing the tank out with gasoline.

d) Spark plug

Do not attempt to remove the plug from a hot engine in order to avoid possible damage to the threads.

- Clean or replace the spark plug in case of ozone contamination.
- Replace the spark plug if the end of the center electrode is worn.

e) Handling and transport

- The engine should be turned off when the unit is moved between work areas.
- After the engine has stopped, the muffler is still hot. Never touch hot parts such as the muffler.
- Confirm that the fuel is not leaked from tank.
- Transport the tool in a way to prevent loss of fuel, injuries and damage.

- Dismantle the cutting head and the blade before transport and storage. Put the blade in its packing.

f) Blade

Always clean and grind the blade, check whether the blade is firmly installed before use, and check whether the blade is damaged if it encounters obstacles. If it is not used for a long time, clean the blade surface and apply lubricant to avoid rust.

g) Grass trimmer

Replacement of the cutting string

- Push the tab which is on the housing cutting string and turn the cover to open it (see the markings on the housing).
- Remove the string and replace it by a new one.
- To reinstall the cutting string, first pass the two ends of the string on the holes localized on the housing.
- Put the cutting string in the housing; pull correctly the string outside of the tool in equal part.
- Place the cover on the housing; turn it to lock it in place.

h) Storage

- Inspect, clean and have the appliance repaired if necessary
- Empty the tank.
- Switch on the appliance to consume all remaining fuel.
- Remove the spark plug and pour a teaspoon of clean engine oil into the cylinder cavity of the spark plug, replace the spark plug
- Store cutting elements so that they cannot be touched (wrap them, for example.)
- Store in a clean, dry, dust-free area.

7. TROUBLESHOOTING

PROBLEM	POSSIBLE CAUSE	CORRECTIVE ACTION
The unit does not start	The tool is not started in the correct way	Star the tool by following the instructions given in this manual
	Problem with the carburettor	The carburettor shall be inspected by an authorized service centre
	Spark plug is worn	Clean/gap or replace plug
	Fuel tank is empty	Fill fuel tank as described in this instruction manual
	Primer bulb was not enough pressed	Press the primer bulb fully and slowly 10 times
The unit starts with a low power	Fuel filter is plugged.	Replace the fuel filter.
	the choke lever is not positioned correctly	The choke lever should be on the OPEN position
	Dirty air filter	Clean the air filter as described in this instruction manual
	Problem with the carburettor	The carburettor shall be inspected by an authorized service centre
the engine sputters	Problem with the carburettor	The carburettor shall be inspected by an authorized service centre
	Air filter is blocked	Clean the air filter as described in this instruction manual
	Old or improperly mixed fuel	Fill fuel tank as described in this instruction manual

Runs erratically	The spark plug is not correctly gapped	adjust or replace the spark plug
	Dirty air filter	Clean the air filter as described in this instruction manual
Smokes excessively	Problem with the carburettor	The carburettor shall be inspected by an authorized service centre

8. DECLARATION OF CONFORMITY



SODILOG SAS
4 RUE CURIE, CS 91617 68016 COLMAR CEDEX FRANCE

declares that the machine:
PETROL BRUSHCUTTER & GRASS TRIMMER
FDBT314T-B

Serial No: 20250802351-20250802500

have been designed in compliance with the following standards:

EN ISO 11806-1:2022
EN ISO 14982:2009

And in accordance with the following directives:

Directive Machine 2006/42/EC
Directive EMC 2014/30/EU
RoHS Directive (EU) 2015/863 amending 2011/65/EU
Emission directive (EU) 2016/1628
noise Directive 2000/14/EC Annex V & Directive 2005/88/EC

Measured sound power level LwA dB(A)
Brush cutter: 104dB(A) K= 3dB(A)
Grass trimmer: 106.5dB(A) K= 3dB(A)
Guaranteed sound power level: 113dB(A)

The people name holding the technical file: Mr. Olivier Patriarca

COLMAR CEDEX, 07/07/2025

Jacques Masson/PDG

9. WARRANTY

The manufacturer guarantees the product against defects in material and workmanship for a period of 5 years from the date of the original purchase. The warranty only applies if the product is for household use. The warranty does not cover breakdowns due to normal wear and tear.

The manufacturer agrees to replace parts identified as defective by the designated distributor. The manufacturer does not accept responsibility for the replacement of the machine, in whole or in part, and/or ensuing damage.

The warranty does not cover breakdowns due to:

- Insufficient maintenance.
- Abnormal assembly, adjustment or operations of the product.
- Parts subject to normal wear and tear.

The warranty does not extend to:

- Shipping and packaging costs.
- Using the tool for a purpose other than that for which it was designed.
- The use and maintenance of the machine done in a manner not described in the user manual.

Due to our policy of continuous product improvement, we reserve the right to alter or change specifications without notice. Consequently, the product may be different from the information contained therein, but a modification will be undertaken without notice if it is recognized as an improvement of the preceding characteristic.

READ THE MANUAL CAREFULLY BEFORE USING THE MACHINE.

When ordering spare parts, please indicate the part number or code, you can find this in the spare parts list in this manual. Keep the purchase receipt; without it, the warranty is invalid. To help you with your product, we invite you to contact us by phone or via our website:

+33 (0)9.70.75.30.30

<https://services.swap-europe.com/contact>

You must create a "ticket" via the web platform.

- Register or create your account.
- Indicate the reference of the tool.
- Choose the subject of your request.
- Describe your problem.
- Attach these files: invoice or sales receipt,

photo of the identification plate (serial number),

photo of the part you need (for example:

pins on the transformer plug which are broken).



10. PRODUCT FAILURE

WHAT TO DO IF MY MACHINE BREAKS DOWN?

If you bought your product in a store:

- Empty the fuel tank.
- Make sure that your machine is complete with all accessories supplied, and clean! If this is not the case, the repairer will refuse the machine.
- Go to the store with the complete machine and with the receipt or invoice.

If you bought your product on a website:

- Empty the fuel tank.
- Make sure that your machine is complete with all accessories supplied, and clean! If this is not the case, the repairer will refuse the machine.
- Create a SWAP-Europe service ticket on the site: <https://services.swap-europe.com> When making the request on SWAP-Europe, you must attach the invoice and the photo of the nameplate (serial number).

Contact the repair station to make sure it is available before dropping off the machine.

Go to the repair station with the complete machine packed, accompanied by the purchase invoice and the station support sheet downloadable after the service request is completed on the SWAP-Europe site

For machines with engine failure from manufacturers BRIGGS & STRATTON, HONDA and RATO, please refer to the following instructions.

Repairs will be done by approved engine manufacturers of these manufacturers, see their site:

- <http://www.briggsandstratton.com/eu/fr>
- <http://www.honda-engines-eu.com/fr/service-network-page;jsessionid=5EE8456CF39CD572AA2AEEDFD290CDAE>
- <https://www.rato-europe.com/it/service-network>

Please keep your original packaging to allow for after-sales service returns or pack your machine with a similar cardboard box of the same dimensions.

For any question concerning our after-sales service you can make a request on our website <https://services.swap-europe.com>

Our hotline remains available at +33 (9) 70 75 30 30.



11. WARRANTY EXCLUSIONS

THE WARRANTY DOES NOT COVER:

- Start-up and setting up of the product.
- Damage resulting from normal wear and tear of the product.
- Damage resulting from improper use of the product.
- Damage resulting from assembly or start-up not in accordance with the user manual.
- Breakdowns related to carburetion beyond 90 days and fouling of carburetors.
- Periodic and standard maintenance events.
- Actions of modification and dismantling that directly void the warranty.
- Products whose original authentication marking (brand, serial number) has been degraded, altered or withdrawn.
- Replacement of consumables.
- The use of non-original parts.
- Breakage of parts following impacts or projections.
- Accessories breakdowns.
- Defects and their consequences linked to any external cause.
- Loss of components and loss due to insufficient screwing.
- Cutting components and any damage related to the loosening of parts.
- Overload or overheating.
- Poor power supply quality: faulty voltage, voltage error, etc.
- Damages resulting from the deprivation of enjoyment of the product during the time necessary for repairs and more generally the costs related to the immobilization of the product.
- The costs of a second opinion established by a third party following an estimate by a SWAP-Europe repair station
- The use of a product which would show a defect or a breakage which was not the subject of an immediate report and/or repair with the services of SWAP-Europe.
- Deterioration linked to transport and storage*.
- Launchers beyond 90 days.
- Oil, petrol, grease.
- Damages related to the use of non-compliant fuels or lubricants.

* In accordance with transport legislation, damage related to transport must be declared to carriers within 48 hours maximum after observation by registered letter with acknowledgement of receipt. This document is a supplement to your notice, a non-exhaustive list.

Attention: all orders must be checked in the presence of the delivery person. In case of refusal by the delivery person, it you must simply refuse the delivery and notify your refusal.

Reminder: the reserves do not exclude the notification by registered letter with acknowledgement within 72 hours.

Information: Thermal devices must be wintered each season (service available on the SWAP-Europe site). Batteries must be charged before being stored.

FEIDER



SODILOG SAS

4 RUE CURIE, CS 91617 68016 COLMAR CEDEX FRANCE

www.sodilog.com

Made in PRC