

# ***Energizer®***



**CORDLESS DRILL**

**EZPV20V2A**

**USER GUIDE**

**CAUTION:** Read this manual before using this machine!

# ***Energizer***®

©2022 Energizer. Energizer and certain graphic designs are trademarks of Energizer Brands, LLC and related subsidiaries and are used under license by Builder SAS. All other brand names are trademarks of their respective owners. Neither Builder SAS nor Energizer Brands, LLC is affiliated with the respective owners of their trademarks.

## **Let's get started.**

You're excited to power up, so we'll keep this brief!

# CONTENTS

1. INTENDED USE.....	5
2. SAFETY INSTRUCTIONS.....	5
3. YOUR PRODUCT.....	10
4. OPERATION.....	11
5. CLEANING AND MAINTENANCE.....	15
6. TECHNICAL DETAILS.....	15
7. DISPOSAL.....	16
8. DECLARATION OF CONFORMITY.....	17
9. WARRANTY.....	18
10. PRODUCT FAILURE.....	19
11. WARRANTY EXCLUSIONS.....	20

# 1. INTENDED USE

The power tool is intended for driving and drilling through wood, metal, plastics and masonry. Not suitable for professional use.



**WARNING:** For your own safety, read this manual and the general safety instructions carefully before using the appliance. Your power tool should only be given to other users together with these instructions.

# 2. SAFETY INSTRUCTIONS

## 2.1 GENERAL POWER TOOL SAFETY WARNINGS



**WARNING:** Read all safety warnings, instructions, illustrations and specifications provided with this power tool. Failure to follow all instructions listed below may result in electric shock, fire and/or serious injury.

**Save all warnings and instructions for future reference.**

The term "power tool" in the warnings refers to your mains-operated (corded) power tool or battery-operated (cordless) power tool.

### 1) Work area safety

- a) **Keep work area clean and well lit.** Cluttered or dark areas invite accidents.
- b) **Do not operate power tools in explosive atmospheres, such as in the presence of flammable liquids, gases or dust.** Power tools create sparks which may ignite the dust or fumes.
- c) **Keep children and bystanders away while operating a power tool.** Distractions can cause you to lose control.

### 2) Electrical safety

- a) **Power tool plugs must match the outlet. Never modify the plug in any way. Do not use any adapter plugs with earthed (grounded) power tools.** Unmodified plugs and matching outlets will reduce risk of electric shock.
- b) **Avoid body contact with earthed or grounded surfaces, such as pipes, radiators, ranges and refrigerators.** There is an increased risk of electric shock if your body is earthed or grounded.
- c) **Do not expose power tools to rain or wet conditions.** Water entering a power tool will increase the risk of electric shock.
- d) **Do not abuse the cord. Never use the cord for carrying, pulling or unplugging the power tool. Keep cord away from heat, oil, sharp edges or moving parts.** Damaged or entangled cords increase the risk of electric shock.
- e) **When operating a power tool outdoors, use an extension cord suitable for outdoor use.** Use of a cord suitable for outdoor use reduces the risk of electric shock.
- f) **If operating a power tool in a damp location is unavoidable, use a residual current device (RCD) protected supply.** Use of an RCD reduces the risk of electric shock.

### 3) Personal safety

- a) **Stay alert, watch what you are doing and use common sense when operating a power tool. Do not use a power tool while you are tired or under the influence of drugs, alcohol or medication.** A moment of inattention while operating power tools may result in serious personal injury.
- b) **Use personal protective equipment. Always wear eye protection.** Protective equipment such as a dust mask, non-skid safety shoes, hard hat or hearing protection used for appropriate conditions will reduce personal injuries.

- c) **Prevent unintentional starting. Ensure the switch is in the off-position before connecting to power source and/or battery pack, picking up or carrying the tool.** *Carrying power tools with your finger on the switch or energising power tools that have the switch on invites accidents.*
  - d) **Remove any adjusting key or wrench before turning the power tool on.** *A wrench or a key left attached to a rotating part of the power tool may result in personal injury.*
  - e) **Do not overreach. Keep proper footing and balance at all times.** *This enables better control of the power tool in unexpected situations.*
  - f) **Dress properly. Do not wear loose clothing or jewellery. Keep your hair and clothing away from moving parts.** *Loose clothes, jewellery or long hair can be caught in moving parts.*
  - g) **If devices are provided for the connection of dust extraction and collection facilities, ensure these are connected and properly used.** *Use of dust collection can reduce dust-related hazards.*
  - h) **Do not let familiarity gained from frequent use of tools allow you to become complacent and ignore tool safety principles.** *A careless action can cause severe injury within a fraction of a second.*
- 4) Power tool use and care**
- a) **Do not force the power tool. Use the correct power tool for your application.** *The correct power tool will do the job better and safer at the rate for which it was designed.*
  - b) **Do not use the power tool if the switch does not turn it on and off.** *Any power tool that cannot be controlled with the switch is dangerous and must be repaired.*
  - c) **Disconnect the plug from the power source and/or remove the battery pack, if detachable, from the power tool before making any adjustments, changing accessories, or storing power tools.** *Such preventive safety measures reduce the risk of starting the power tool accidentally.*
  - d) **Store idle power tools out of the reach of children and do not allow persons unfamiliar with the power tool or these instructions to operate the power tool.** *Power tools are dangerous in the hands of untrained users.*
  - e) **Maintain power tools and accessories. Check for misalignment or binding of moving parts, breakage of parts and any other condition that may affect the power tool's operation. If damaged, have the power tool repaired before use.** *Many accidents are caused by poorly maintained power tools.*
  - f) **Keep cutting tools sharp and clean.** *Properly maintained cutting tools with sharp cutting edges are less likely to bind and are easier to control.*
  - g) **Use the power tool, accessories and tool bits etc. in accordance with these instructions, taking into account the working conditions and the work to be performed.** *Use of the power tool for operations different from those intended could result in a hazardous situation.*
  - h) **Keep handles and grasping surfaces dry, clean and free from oil and grease.** *Slippery handles and grasping surfaces do not allow for safe handling and control of the tool in unexpected situations.*
- 5) Battery tool use and care**
- a) **Recharge only with the charger specified by the manufacturer.** *A charger that is suitable for one type of battery pack may create a risk of fire when used with another battery pack.*
  - b) **Use power tools only with specifically designated battery packs.** *Use of any other battery packs may create a risk of injury and fire.*
  - c) **When battery pack is not in use, keep it away from other metal objects, like paper clips, coins, keys, nails, screws or other small metal objects, that can make a connection from one terminal to another.** *Shorting the battery terminals together may cause burns or a fire.*
  - d) **Under abusive conditions, liquid may be ejected from the battery; avoid contact. If contact accidentally occurs, flush with water. If liquid contacts eyes, additionally seek medical help.** *Liquid ejected from the battery may cause irritation or burns.*

- e) **Do not use a battery pack or tool that is damaged or modified.** *Damaged or modified batteries may exhibit unpredictable behaviour resulting in fire, explosion or risk of injury.*
- f) **Do not expose a battery pack or tool to fire or excessive temperature.** *Exposure to fire or temperature above 130°C may cause explosion.*  
**NOTE:** The temperature 130°C can be replaced by the temperature 265°F.
- g) **Follow all charging instructions and do not charge the battery pack or tool outside the temperature range specified in the instructions.** *Charging improperly or at temperatures outside the specified range may damage the battery and increase the risk of fire.*

## 6) Service

- a) **Have your power tool serviced by a qualified repair person using only identical replacement parts.** *This will ensure that the safety of the power tool is maintained.*
- b) **Never service damaged battery packs.** *Service of battery packs should only be performed by the manufacturer or authorized service providers.*

## 2.2 DRILL SAFETY WARNINGS

- a) **Wear ear protectors when impact drilling.** *Exposure to noise can cause hearing loss.*
- b) **Use auxiliary handle(s), if supplied with the tool.** *Loss of control can cause personal injury.*
- c) **Hold power tool by insulated gripping surfaces, when performing an operation where the cutting accessory may contact hidden wiring.** *Cutting accessory contacting a "live" wire may make exposed metal parts of the power tool "live" and could give the operator an electric shock.*

## 2.3 SAFETY INSTRUCTIONS WHEN USING LONG DRILL BITS

- a) **Never operate at higher speed than the maximum speed rating of the drill bit.** *At higher speeds, the bit is likely to bend if allowed to rotate freely without contacting the workpiece, resulting in personal injury.*
- b) **Always start drilling at low speed and with the bit tip in contact with the workpiece.** *At higher speeds, the bit is likely to bend if allowed to rotate freely without contacting the workpiece, resulting in personal injury.*
- c) **Apply pressure only in direct line with the bit and do not apply excessive pressure.** *Bits can bend causing breakage or loss of control, resulting in personal injury.*

## 2.4 SAFETY INSTRUCTIONS FOR BATTERIES AND CHARGER

### 1) Batteries

- Never attempt to open for any reason.
- Do not store in locations where the temperature may exceed 40°C (104°F).
- Charge only at ambient temperatures between 4°C and 40°C(39.2°F and 104°F).
- Charge only using the charger provided with the tool.
- Store your batteries in a cool dry place (5°C-20°C/41°F-68°F). Never store batteries in discharged state.
- It is better for Li-ion batteries to discharge and reload them regularly (at least 4 times a year). The ideal charge for long-term storage of your Li-ion battery is 40% of capacity.
- When disposing of batteries, follow the instructions given in the section "Protecting the environment".
- Do not cause short circuits. If connection is made between the positive (+) and negative (-) terminal directly or via accidental contact with metallic objects, the battery is short circuited and an intense current will flow causing heat generation which may lead to casing rupture or fire.
- Do not heat. If batteries are heated to above 100°C (212°F), sealing and insulating separators and other polymer components may be damaged resulting in electrolyte leakage and/or internal short circuiting,

leading to heat generation causing rupture or fire. Moreover do not dispose of the batteries in fire, explosion and/or intense burning may result.

- Under extreme conditions, battery leakage may occur. When you notice liquid on the battery, proceed as follows:
  - Carefully wipe the liquid off using a cloth. Avoid skin contact.
  - In case of skin or eye contact, follow the instructions below:
    - Immediately rinse with water. Neutralize with a mild acid such as lemon juice or vinegar.
    - In case of eye contact, rinse abundantly with clean water for at least 10 minutes.
    - Consult a physician.



**Fire hazard! Avoid short-circuiting the contacts of a detached battery. Do not incinerate the battery.**

## 2) Charger











- Use the charger provided with the tool only to charge the battery.
- Never attempt to charge non-rechargeable batteries.
- Have defective cords replaced immediately.
- Do not expose to water.
- Do not open the charger.
- Do not probe the charger.
- The charger is intended for indoor use only.
- This charger can be used by children aged from 8 years and above and persons with reduced physical, sensory or mental capabilities or lack of experience and knowledge if they have been given supervision or instruction concerning use of the appliance in a safe way and understand the hazards involved.
- Children shall not play with the appliance. Cleaning and user maintenance shall not be made by children without supervision.



- If the supply cord is damaged, it must be replaced by the manufacturer, its service agent or similarly qualified persons in order to avoid a hazard.

**⚠ CAUTION:** Do not recharge non-rechargeable batteries.

## 2.5 SYMBOLS

	Conforms to relevant safety standards.
	To reduce the risk of injury, the user must read and understand this manual before using this product.
	Wear ear protection. Exposure to noise can cause hearing loss.
	Wear eye protection.
	Class II, double isolation (only for charger).
	Do not dispose of old appliances with domestic rubbish.
	Do not expose the charger or the battery to water.
	Do not incinerate the battery or charger.
	Ambient temperature of 40°C max. (only for the battery).
	Battery and charger to be used indoors only.
	Recycling.

# 3. YOUR PRODUCT

## 3.1 DESCRIPTION

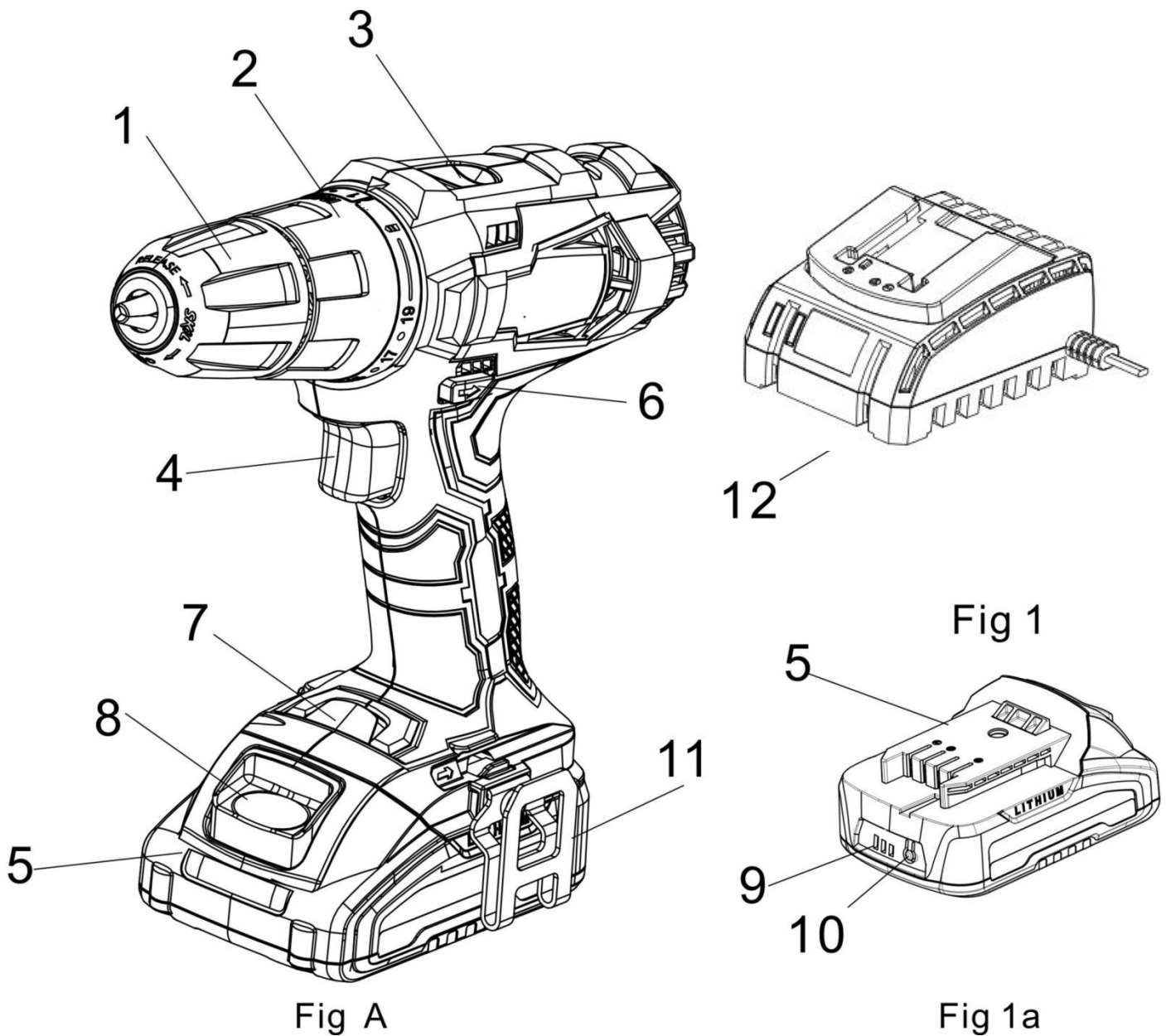

- |                           |   |
|---------------------------|---|
| 1. Keyless chuck          | 7. LED work light                         |
| 2. Torque adjustment ring | 8. Battery pack release button            |
| 3. Two speed selector     | 9. Battery capacity indicator             |
| 4. On/off switch trigger  | 10. Button for battery capacity indicator |
| 5. Battery pack           | 11. Belt clip                             |
| 6. Forward/reverse knob   | 12. Charger                               |

## 3.2 FEATURES

### 1) Li-ion battery (5)

Advantages of Li-ion batteries:

- Li-ion batteries have a higher capacity/weight ratio (more power for less heavy, more compact).
- No memory effect (capacity loss after several charge/discharge cycles) like other type of batteries.
- Limited self-discharge.

## 2) Keyless chuck (1)

Your drill has a keyless chuck that allows you to hand tighten or release drill bit in the chuck jaws.

## 3) Torque adjustment ring (2)

The drill has a torque adjustment ring. It allows you to select the desired torque depending on the task you have to perform (screwing/different types of screws into different materials). The proper setting depends on the type of material and the size of screw you are using.

## 4) Forward/reverse selector (right/left rotation selector) (6)

The drill has a forward/reverse selector located above the switch trigger.



**CAUTION:** To prevent damage to the gearbox, always allow the chuck to come to a complete stop before changing the direction of rotation or selecting another speed (HI-LO). To stop, release the trigger switch.

## 5) Variable speed

Your cordless drill has a variable speed switch. The rotational speed and torque will decrease equivalently to applied trigger pressure. This drill has an electric brake, when the trigger switch is released, the chuck stops turning.

## 6) Speed selector (3)

Your cordless drill has a two-speed gear, designed for drilling or driving at LO(1) or HI (2) speed. A slide switch is located on top of your drill to select either LO(1) or HI (2) speed.

## 7) LED light (7)

Your cordless drill is equipped with an LED light at the front, above the battery pack.

## 8) TPR soft grip

Your cordless drill is equipped with TPR soft grip and protective parts. TPR (Thermoplastic rubber) is elastic, shock absorbing and environmental friendly (recyclable).

# 4. OPERATION

## 4.1 CHARGING THE BATTERY PACK



**IMPORTANT:** The battery pack is not fully charged at the factory. Before attempting to charge them, thoroughly read all of the safety instructions.

- Assure that the charger you are using matches your battery pack.
- Insert the charger into 220-240V~, 50-60Hz outlet. The indicator light (13) will turn red to show the power is connected.
- Insert the battery(5) into the slot of charger(12). Make sure the contact with the charger is correct.
- The indicator light (13) become to green and flash when charging.
- When fully charged The indicator light (13) become green.

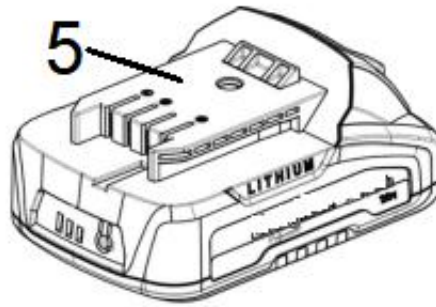
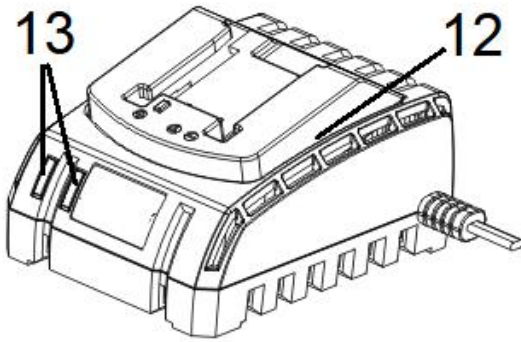

- Frequently monitor the charger and battery pack while connected.
- Unplug the charger and disconnect it from the battery pack when finished.
- Allow the battery pack to cool completely before using it.
- Store the charger and battery pack indoors, out of reach of children.



**NOTE:** If the battery does not fit properly, disconnect it and confirm that the battery pack is the correct model for this charger as shown on the specification chart. Do not charge any other battery pack or any battery pack that does not securely fit the charger.



**NOTE:** If battery is hot after continuous use in the tool, allow it to cool down to room temperature before charging. This will extend the life of your batteries.



**NOTE:** Using your thumb or fingers to press the battery's release button in and pull the battery pack off at the same time.

#### Battery capacity indicator (Fig. 1a)

There are battery capacity indicators on the battery pack; you can check the capacity status of the battery if you press the button. Before using the machine, please press switch trigger to check if the battery is full enough to work properly.

#### Inserting and removing the battery



**WARNING:** Before making any adjustments ensure the drill is switched off with the direction of rotation selector in the center position.

- To remove the battery: press the battery release latch in and at the same time pull the battery pack off.
- To insert the battery: push the battery pack onto the contacts of the tool.

## 4.2 INSTALLING AND REMOVING A BIT AND A DRILL

- This drill has a keyless chuck to prevent the bit or drill from loosening and allows you to hand tighten or release drill bit in the chuck jaws.
- Turn ring A anticlockwise with the other hand until the drill chuck opening is large enough to accept the tool.
- Insert the drill or the screwdriver bit into the drill chuck.
- Turn ring A clockwise until the tool is clamped tightly.
- Remove the tool in the opposite way.

## 4.3 SWITCH (4)

The drill is started and stopped by depressing and releasing the ON/OFF switch trigger.

## 4.4 SWITCH LOCK

- The switch trigger can be locked in the center position.
- This helps to reduce the possibility of accidental starting when not in use. To lock the switch trigger, place the direction of rotation selector in the center position.

## 4.5 DIRECTION OF ROTATION

Direction of rotation is controlled by the direction of rotation selector located above the switch trigger.

## 4.6 CLOCKWISE ROTATION

Right: To select forward rotation, release the on/off switch and push the forward/reverse lever to the left side of the tool.

## 4.7 ANTICLOCKWISE ROTATION

Left: To select reverse rotation, push the lever to the right side of the tool.



## 4.8 VARIABLE SPEED

- This tool has a variable speed switch that delivers higher speed and torque with increased trigger pressure.
- Speed is controlled by the amount of switch trigger depression.

## 4.9 ADJUSTING THE TORQUE

- The torque is adjusted by rotating the torque setting ring; the torque is greater when the torque setting is set on a higher position. The torque is less when the torque setting ring is set on a low position “1” denotes lowest and “21” denote highest.
- Torque is set by means of a torque setting according to different screw and different material, you can adjust suitable torque, if the screw is long and material is hard, you can adjust the bigger setting.

## 4.10 FUNCTION MODE SELECTOR

- Turn the function mode selector and let the pointer align to the drill mode  that selects the drill mode of action.
- Turn the function mode selector and let the pointer align to the screwdriver mode  that selects the screwdriver mode of action.

## 4.11 SPEED SELECTOR

The drill has a two-speed gear train designed for drilling at 1 (LOW) or 2 (HIGH) speed.

A gear selector is located on top of the drill to select either low or high speed.

When you push the button forward and select low speed range, the speed will decrease but will provide more power and torque. When using drill in the high-speed range. Speed will increase but will provide less power and torque. Use low speed for high power and torque application and high speed for fast drilling applications.



**IMPORTANT: never adjust this two-speed selector whilst the drill is running. Always let it come to a complete stop first.**

## 4.12 LED LIGHT

The LED work-light can light prior to motor running if you press the switch lightly, which keep the work area to be lighted for checking clearly at first, and it lights also during your operation.



**WARNING:** Do not stare directly at the light beam. Never aim the beam at any person or an object other than the work piece.



**WARNING:** Do not deliberately aim the beam at personnel and ensure that it is not directed towards the eye of a person for longer than 0.25s.

## 4.13 DRILLING

### 1) Drilling

Before use for drilling, the function mode selector should be set on drill position

When drilling hard smooth surface, use a center punch to mark the desired hole location. This will prevent the drill bit from slipping off center as the hole is started. Hold the tool firmly and place the tip of the drill or bit into the work piece, applying only enough pressure to keep the bit cutting. Do not force or apply side pressure to elongate a hole.

### 2) Wood drilling

For maximum performance, use high speed steel bits for wood drilling. Turn the function mode selector on the drill mode

Begin drilling at a very low speed to prevent the bit from slipping off the starting point. Increase the speed as the drill bit bites into the material. When drilling through holes, place a block of wood behind the workpiece to prevent ragged or sintered edges on the back side of the hole.

### 3) Metal drilling

For maximum performance, use high speed steel bits for metal or steel drilling. Turn the function mode selector on the drill mode

Begin drilling at a very low speed to prevent the bit from slipping off the starting point. Maintain a speed and pressure which allows cutting without overheating the bit.

#### Applying too much pressure will:

- Overheat the drill.
- Wear the bearings.
- Bend or burn bits.
- Produce off-center or irregular shaped holes.

When drilling large holes in metal, it is recommended that you drill with a small bit at first, then finish with a large bit. Also lubricate the bit with oil to improve drilling action and increase bit life.

### 4) Driving screw

- For maximum performance, use good quality bits for driving screws, turn the function mode selector on the screwdriver mode position “21”.
- Fix the torque setting low enough to allow a safety margin. Use a very low torque setting when first driving small screws into soft materials. Then adjust the setting as the proper force required is determined.



**NOTE:** The torque setting required depends on the item being driven. In the case of screws, consider the size, length, and type of material.

## 5. CLEANING AND MAINTENANCE

### 5.1 CLEANING

- Keep the ventilation slots of the machine clean to prevent overheating of the engine.
- Regularly clean the machine housing with a soft cloth, preferably after each use.
- Keep the ventilation slots free from dust and dirt.
- If the dirt does not come off use a soft cloth moistened with soapy water.
- Never use solvents such as petrol, alcohol, ammonia water, etc. These solvents may damage the plastic parts.

### 5.2 MAINTENANCE

Our machines have been designed to operate over a long period of time with a minimum of maintenance. Continuous satisfactory operation depends upon proper machine care and regular cleaning.

## 6. TECHNICAL DETAILS

Power supply	20V d.c.
Chuck	13 mm, keyless
Gear Train	2 Speed
No Load Speed	0-400/0-1600min <sup>-1</sup>
Torque adjustment	19+1 Positions
Charger type	EZPV20V2A Input: 220-240V~ 50-60Hz, 65W Output: 21V d.c., 2.5A
Battery type	EZPV20V2A 20V d.c. 2Ah Lithium-ion
Sound pressure level LpA	LpA =75dB(A) Uncertainty: K=5 dB(A)
Sound power level LwA	LwA =86dB(A) Uncertainty: K=5 dB(A)
aw (Vibration)	Drilling model:<2.5m/s <sup>2</sup> , K=1.5m/s <sup>2</sup> .

## INFORMATION

- The declared vibration total value(s) and the declared noise emission value(s) have been measured in accordance with a standard test method and may be used for comparing one tool with another.
- The declared vibration total value(s) and the declared noise emission value(s) may also be used in a preliminary assessment of exposure.



### WARNING:

- The vibration and noise emissions during actual use of the power tool can differ from the declared values depending on the ways in which the tool is used especially what kind of workpiece is processed.
- Need to identify safety measures to protect the operator that are based on an estimation of exposure in the actual conditions of use (taking account of all parts of the operating cycle such as the times when the tool is switched off and when it is running idle in addition to the trigger time).
- Wear hearing protection.

## 7. DISPOSAL



Electrical products should not be discarded with household products. According to the European Directive 2012/19/EU on waste electrical and electronic equipment and its implementation into national law, electrical products used must be collected separately and disposed of at collection points provided for this purpose. Talk with your local authorities or dealer for advice on recycling.

### BATTERY PACK



**Li-ion**

This product contains Li-ion. To preserve natural resources, please recycle or dispose of batteries properly. Local, state or federal laws may prohibit disposal of Li-ion batteries in ordinary trash. Consult you local waste authority for information regarding available recycling and/or disposal options.



## 8. DECLARATION OF CONFORMITY



**BUILDER SAS**

**32, rue Aristide Bergès - ZI 31270 Cugnaux - France,**

declares that:

Product: Cordless drill 20V

Trade mark: ENERGIZER

Model: EZPV20V2A

Serial number: 20220651357-20220651856

Is in conformity with the essential requirements and other relevant provisions of the applicable European Directives, based on the application of European harmonized standards. Any unauthorized modification of the apparatus voids this declaration.

European Directives (including, if applicable, their amendments up to the date of signature);

Rohs directive 2011/65/EU + (EU) 2015/863

Directive Machine 2006/42/EC

Directive EMC 2014/30/UE

LVD Directive 2014/35/UE

European harmonized standards (including, if applicable, their amendments up to the date of signature);

EN62841-1: 2015

EN62841-2-1: 2018+A11: 2019

EN55014-1: 2017+A11:2020

EN55014-2: 2015

EN 62233:2008

EN 60335-2-29:2004+A2:2010+A11:2018

EN 60335-1:2012+A11:2014+A13:2017+A1:2019+A2:2019+A14:2019+A2:2019

EN IEC61000-3-2:2019; EN 61000-3-3:2013+A1:2019

Cugnaux, 21/03/2022

Philippe MARIE / PDG

Responsible of the technical file: Mr Olivier Patriarca

## 9. WARRANTY



### WARRANTY

The manufacturer guarantees the product against defects in material and workmanship for a period of 2 years from the date of the original purchase. The warranty only applies if the product is for household use. The warranty does not cover breakdowns due to normal wear and tear.

The manufacturer agrees to replace parts identified as defective by the designated distributor. The manufacturer does not accept responsibility for the replacement of the machine, in whole or in part, and/or ensuing damage.

**The warranty does not cover breakdowns due to:**

- insufficient maintenance.
- abnormal assembly, adjustment or operations of the product.
- parts subject to normal wear and tear.

**The warranty does not extend to:**

- shipping and packaging costs.
- using the tool for a purpose other than that for which it was designed.
- the use and maintenance of the machine done in a manner not described in the user manual.

Due to our policy of continuous product improvement, we reserve the right to alter or change specifications without notice. Consequently, the product may be different from the information contained therein, but a modification will be undertaken without notice if it is recognized as an improvement of the preceding characteristic.

#### **READ THE MANUAL CAREFULLY BEFORE USING THE MACHINE.**

When ordering spare parts, please indicate the part number or code, you can find this in the spare parts list in this manual. Keep the purchase receipt; without it, the warranty is invalid. To help you with your product, we invite you to contact us by phone or via our website:

- **+33 (0)9.70.75.30.30**
- **<https://services.swap-europe.com/contact>**

You must create a "ticket" via the web platform.

- Register or create your account.
- Indicate the reference of the tool.
- Choose the subject of your request.
- Describe your problem.
- Attach these files: invoice or sales receipt, photo of the identification plate (serial number), photo of the part you need (for example: pins on the transformer plug which are broken).



# 10. PRODUCT FAILURE

## WHAT TO DO IF MY MACHINE BREAKS DOWN?

### **If you bought your product in a store:**

- a) Empty the fuel tank if your product has one.
- b) Make sure that your machine is complete with all accessories supplied, and clean! If this is not the case, the repairer will refuse the machine.

Go to the store with the complete machine and with the receipt or invoice.

### **If you bought your product on a website:**

- a) Empty the fuel tank if your product has one.
- b) Make sure that your machine is complete with all accessories supplied, and clean! If this is not the case, the repairer will refuse the machine.
- c) Create a SWAP-Europe service ticket on the site: <https://services.swap-europe.com> When making the request on SWAP-Europe, you must attach the invoice and the photo of the nameplate (serial number).
- d) Contact the repair station to make sure it is available before dropping off the machine.

Go to the repair station with the complete machine packed, accompanied by the purchase invoice and the station support sheet downloadable after the service request is completed on the SWAP-Europe site.

For machines with engine failure from manufacturers BRIGGS & STRATTON, HONDA and RATO, please refer to the following instructions.

Repairs will be done by approved engine manufacturers of these manufacturers, see their site:

- <http://www.briggsandstratton.com/eu/fr>
- <http://www.honda-engines-eu.com/fr/service-network-page;jsessionid=5EE8456CF39CD572AA2AEEDFD290CDAE>
- <https://www.rato-europe.com/it/service-network>

**Please keep your original packaging to allow for after-sales service returns or pack your machine with a similar cardboard box of the same dimensions.**

**For any question concerning our after-sales service you can make a request on our website <https://services.swap-europe.com>**

**Our hotline remains available at +33 (9) 70 75 30 30.**



# 11. WARRANTY EXCLUSIONS

## THE WARRANTY DOES NOT COVER:

- Start-up and setting up of the product.
- Damage resulting from normal wear and tear of the product.
- Damage resulting from improper use of the product.
- Damage resulting from assembly or start-up not in accordance with the user manual.
- Breakdowns related to carburetion beyond 90 days and fouling of carburetors.
- Periodic and standard maintenance events.
- Actions of modification and dismantling that directly void the warranty.
- Products whose original authentication marking (brand, serial number) has been degraded, altered or withdrawn.
- Replacement of consumables.
- The use of non-original parts.
- Breakage of parts following impacts or projections.
- Accessories breakdowns.
- Defects and their consequences linked to any external cause.
- Loss of components and loss due to insufficient screwing.
- Cutting components and any damage related to the loosening of parts.
- Overload or overheating.
- Poor power supply quality: faulty voltage, voltage error, etc.
- Damages resulting from the deprivation of enjoyment of the product during the time necessary for repairs and more generally the costs related to the immobilization of the product.
- The costs of a second opinion established by a third party following an estimate by a SWAP-Europe repair station.
- The use of a product which would show a defect or a breakage which was not the subject of an immediate report and/or repair with the services of SWAP-Europe.
- Deterioration linked to transport and storage\*.
- Launchers beyond 90 days.
- Oil, petrol, grease.
- Damages related to the use of non-compliant fuels or lubricants.

\* In accordance with transport legislation, damage related to transport must be declared to carriers within 48 hours maximum after observation by registered letter with acknowledgement of receipt.

This document is a supplement to your notice, a non-exhaustive list.

**Attention:** All orders must be checked in the presence of the delivery person. In case of refusal by the delivery person, you must simply refuse the delivery and notify your refusal.

**Reminder:** The reserves do not exclude the notification by registered letter with acknowledgement within 72 hours.

**Information:** Thermal devices must be wintered each season (service available on the SWAP-Europe site). Batteries must be charged before being stored.







***Energizer***®