

Energizer®



**EZG SERIES
EZG2000iUK
USER GUIDE**

Energizer[®]

©2018 Energizer. Energizer and certain graphic designs are trademarks of Energizer Brands, LLC and related subsidiaries and are used under license by Builder SAS.

All other brand names are trademarks of their respective owners.

Neither Builder SAS nor Energizer Brands, LLC is affiliated with the respective owners of their trademarks.

Thanks for choosing the EZG Series!

You're excited to power up, so we'll keep this brief. Let's get started!

CONTENT

1. SAFETY INFORMATION	- 9 -
1.1 OPERATOR ATTENTION	- 9 -
1.2 EXHAUST FUMES HAZARDS	- 10 -
1.3 ELECTRIC SHOCK HAZARDS	- 11 -
1.4 FIRE AND BURN HAZARDS	- 12 -
1.5 CONNECTION NOTES	- 13 -
2. IMPORTANT LABEL LOCATIONS.....	- 14 -
3. UNIT DESCRIPTION	- 24 -
3.1 COMPONENTS IDENTIFICATION	- 24 -
3.2 CONTROL PANEL	- 26 -
4. PREPARATION	- 27 -
4.1 ENGINE OIL.....	- 27 -
4.2 FUEL	- 29 -
5. STARTING THE ENGINE	- 30 -
5.1 CHECK ENGINE OIL	- 31 -
5.2 CHECK FUEL.....	- 32 -
5.3 OPEN THE FUEL CAP VENT LEVER	- 33 -
5.4 OPEN THE FUEL TAP	- 34 -
5.5 THE ENGINE SWITCH & ECO SWITCH.....	- 35 -
5.6 USE CHOKE	- 36 -
5.7 START THE ENGINE	- 37 -
5.8 CLOSE CHOKE	- 38 -
6. AC OPERATION.....	- 39 -
6.1 USE THE GENERATOR:	- 39 -
6.2 SHUT DOWN THE GENERATOR:	- 41 -
7. DC OPERATION	- 43 -
7.1 CONNECTING THE BATTERY CHARGING CABLE:	- 44 -
7.2 DISCONNECTING THE BATTERY CHARGING CABLE:	- 45 -
8. AC PARALLEL OPERATION.....	- 46 -
8.1 START AC PARALLEL	- 46 -
8.2 STOP AC PARALLEL	- 47 -

9. SPECIAL REQUIREMENTS	- 48 -
10. MAINTENANCE	- 49 -
10.1 ENGINE OIL CHANGE	- 51 -
10.2 AIR CLEANER SERVICE.....	- 53 -
10.3 SPARK PLUG SERVICE.....	- 54 -
10.4 SPARK ARRESTER MAINTENANCE.....	- 56 -
10.5 CLEANING FUEL TANK FILTER	- 59 -
11. TRANSPORTATION AND STORAGE	- 60 -
11.1 DRAIN THE FUEL FROM THE CARBURETOR.....	- 61 -
11.2 DRAIN THE FUEL FROM FUEL TANK.....	- 62 -
11.3 DRAIN THE FUEL FROM THE CARBURETOR AGAIN	- 63 -
11.4 ENGINE.....	- 64 -
12. TROUBLE SHOOTING	- 65 -
13. SPECIFICATIONS.....	- 70 -
14. WIRING DIAGRAM	- 72 -
15. ENVIRONMENT CORRECTION	- 73 -

⚠ WARNING

Read this manual carefully before operating this generator. This manual should stay with this generator if it is sold.



WARNING:



The engine exhaust fumes from this product contain poisonous carbon monoxide (CO) to cause loss of consciousness and may lead to death.

⚠ WARNING

Exhaust contains poisonous carbon monoxide (CO) gas that can build up to dangerous levels in closed areas.

Breathing CO can cause unconsciousness or death.

Never run the generator in a closed or even partially closed area where people may be present.

⚠ WARNING

The generator is a potential source of electrical shock if misused. Do not expose the generator to moisture, rain or snow. Do not let the generator get wet, and do not operate it with wet hands.

Keep this owner's manual handy, so you can refer to it at any time. We reserve the right to modify this product or manual at any time without any notice.

⚠ WARNING

PLEASE READ AND UNDERSTAND THIS MANUAL COMPLETELY BEFORE OPERATING THE GENERATOR.

This manual will provide you with a good basic understanding of the operation and maintenance of this machine.

We continually seek advancements in product design and quality. Therefore, while this manual is the newest, there may be slight difference between your generator and this manual.

INTRODUCTION

Congratulations on your selection of a marvelous generator. This manual will provide you with a good basic understanding of the operation and maintenance of this machine, please read it carefully.

These signal words mean:

 **DANGER**

You **WILL** be **KILLED** or **SERIOUSLY HURT** if you don't follow instructions.

 **WARNING**

You **CAN** be **KILLED** or **SERIOUSLY HURT** if you don't follow instructions.

 **CAUTION**

You **CAN** be **HURT** if you don't follow instructions.

This manual is filled with important safety information — please read it carefully.

If you have any questions, please consult an authorized dealer.

1. SAFETY INFORMATION

1.1 OPERATOR ATTENTION

⚠ WARNING

- Read and understand this manual before operating the generator.
- Place the generator in a place where pedestrians, children and pets are not likely to touch. Never let children operate the generator.

⚠ WARNING

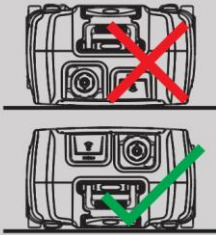

Use only after stopping engine

- The generator is allowed to be put down, but **ONLY** lay on the Drawbar Side, and only after stopping the engine. If lay down on other side, OIL may leak and damage the engine or your property. Also FUEL may leak and cause FIRE or an EXPLOSION.

⚠ WARNING

Before putting down the generator, proceed as follows:

1. Turn OFF fuel tap.
2. Close fuel cap tightly.
3. Turn OFF fuel cap vent lever.



- Turn OFF the Fuel Tap, Close the Fuel Cap tightly and turn OFF the Fuel Cap Vent Lever before putting down the generator.
- DO NOT remove any cover of the generator case when the engine is running. If not, inverter, alternator or other electric

parts may be damaged because of bad cooling.

1.2 EXHAUST FUMES HAZARDS

⚠ DANGER

Using a generator indoors **CAN KILL YOU IN MINUTES.**
Generator exhaust contains carbon monoxide.
This is a poison you cannot see or smell.



NEVER use inside a home or garage, **EVEN IF** doors and windows are open.

Only use **OUTSIDE** and far away from windows, doors, and vents.

- **Exhaust fumes contains poisonous carbon monoxide (CO) , a colorless and odorless gas. Breathing CO can cause loss of consciousness and may lead to death.**
- **Never run your generator inside a garage or house, even if door or window is open. Operate the generator in a well-ventilated area.**

1.3 ELECTRIC SHOCK HAZARDS

⚠ WARNING

 Read owner's manual and all labels before operating.

 Only operate in well-ventilated areas. Exhaust gas contains poisonous carbon monoxide.

 Ground unit to avoid electrical hazards.

 Keep unit dry. Do not expose unit to rain or wet locations.

 Stop engine before refueling. Check for spilled fuel or fuel leaks. Do not operate near flammable materials. Turn OFF the fuel tap after unit is used.

 This symbol indicates that when the end-user wishes to discard this product, it must be sent to separate collection facilities for recovery and recycling.

- Never operate the engine in rain, snow or wet locations.
- Never touch the machine with wet hands.
- Ground unit to avoid electrical hazards.

1.4 FIRE AND BURN HAZARDS



- Gasoline is extremely flammable and explosive under certain conditions. Do not smoke or allow flames or sparks where the generator is refueled or where gasoline is stored. Refuel in a well-ventilated area with the engine stopped and cooled.
- The generator is allowed to be put down, but **ONLY** lay down on the Drawbar Side. If lay down on other side, OIL may leak and damage the engine or your property. Also FUEL may leak and cause FIRE or an EXPLOSION.
- The muffler becomes very hot during operation and remains hot for a while after stopping the engine. Be careful not to touch the muffler while it is hot.
- Avoid placing any flammable materials near the exhaust outlet during operation.

- Keep the generator at least 1 m (3 ft.) from buildings or other equipment, or the generator may overheat.
- Let the engine cool before storing the generator indoors.

1.5 CONNECTION NOTES

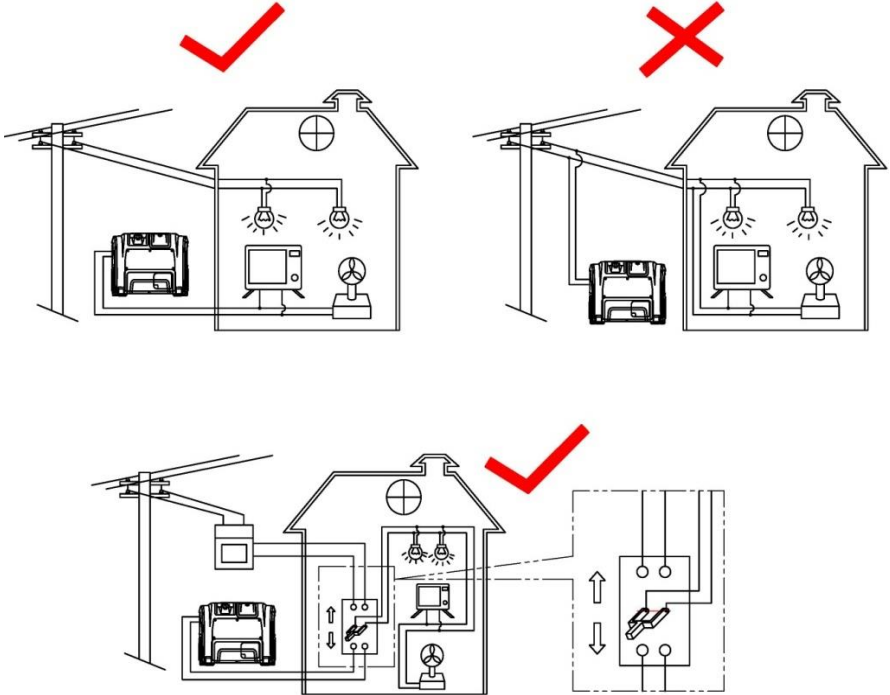

- Do not connect to a building electrical system unless an isolation switch has been installed by a qualified electrician.
- Avoid connecting the generator in parallel with any other generator.

2. IMPORTANT LABEL LOCATIONS

Please read the following labels carefully before operating this generator.

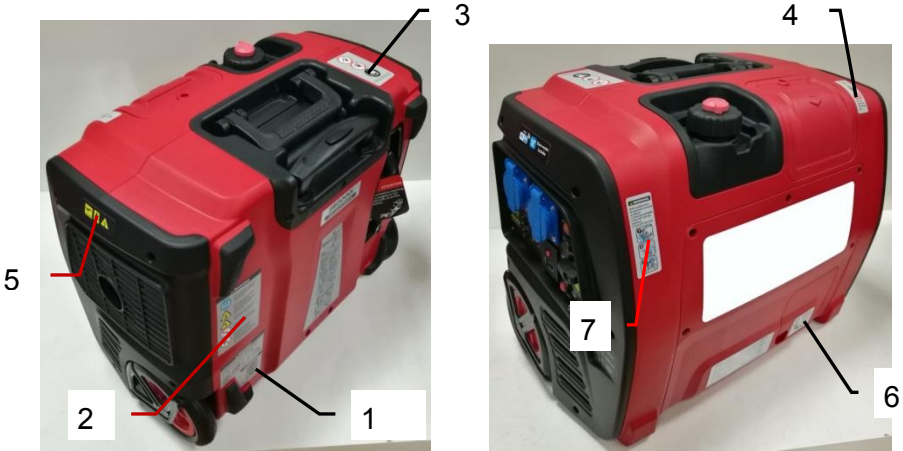

①

⚠ DANGER

Using a generator indoors **CAN KILL YOU IN MINUTES**. Generator exhaust contains carbon monoxide. This is a poison you cannot see or smell.



NEVER use inside a home or garage, EVEN IF doors and windows are open.



Only use OUTSIDE and far away from windows, doors, and vents.

⚠ WARNING



Use only after stopping engine

②

⚠ WARNING



Read owner's manual and all labels before operating.



Only operate in well-ventilated areas. Exhaust gas contains poisonous carbon monoxide.



Ground unit to avoid electrical hazards.



Keep unit dry. Do not expose unit to rain or wet locations.



Stop engine before refueling. Check for spilled fuel or fuel leaks. Do not operate near flammable materials. Turn OFF the fuel tap after unit is used.



This symbol indicates that when the end-user wishes to discard this product, it must be sent to separate collection facilities for recovery and recycling.

③



④



⑤



⑥



⑦

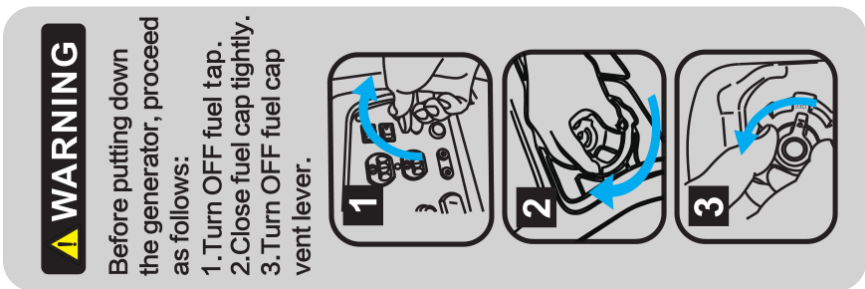



Danger! Electrical hazard



Guarantee sound power level



Read instruction manual before use



Caution! Risk of being burnt



Caution! Fire hazard



Carbon monoxide (CO) danger



Caution

- The operator must know the principles of functioning and the structure of the generator and the motor. He must know how to stop the motor in case of urgency and how to manipulate the controls.
- Never let children use this device.
- Never let people who do not know these instructions use this device. Local regulations may impose restrictions on the age of the user.
- Please do not use this device when people, especially children, or pets are nearby. Direct them away from the working area.
- The operator or the user are responsible for possible accidents or damage to other persons or to their property.
- Do not wear loose clothing or jewellery as this can get caught in the machinery as it runs.
- Use safety equipment. Wear protective gear such as an anti-dust mask, non-slip safety shoes, and a helmet or hearing protection.
- Stay vigilant, watch what you are doing and show good sense when you use the generator. Do not use if you are tired or under the influence of drugs, alcohol or medicines.
- Install the generator in a place that is well ventilated and make sure that there is at least 1.5 meters between the generator and the walls of the building or other equipment. Do not place flammable liquids or gases near the generator.
- Do not run the generator in an enclosed or badly-ventilated space. The exhaust gas from the motor contains carbon monoxide which is toxic and may lead to a loss of consciousness or death.
- Run the generator in respect of the power indicated in the user's manual. Do not run the generator with an overload or at excessive speed.
- The silencer of the generator becomes extremely hot when the motor runs or even for a time after it has stopped. Do not touch it as it will burn you.

- Do not transport or move the generator until it has cooled down.
- Perform periodic maintenance and resolve problems that appear immediately. Do not run the generator before correcting any fault detected.
- The generator uses a system of air-cooling, and it is necessary to clean its components regularly, including the grilles, the cover of the fan and the fan itself so as to ensure cooling.
- Keep the fuel filter clean, and change the oil of the motor regularly.
- Periodically check the installation of the connections and the tightness of the fixations, re-tightening them if necessary.
- Clean the components of the air filter periodically, and replace the air filter when necessary.
- Remove any electrical equipment that is plugged in before starting or stopping the generator.
- Before transporting the generator, you must empty the fuel tank.
- Maintenance and repair of the generator must be carried out by a qualified technician from an authorized after-sales service center.
- The generator must not be altered or modified. Any intervention must be done by an authorized after-sales service center.
- Installation and major repair work shall be carried out only by specifically trained personnel

Warning: when you start the generator with the cord, watch out for sudden changes in the rotation of the motor!!! Risk of wounding!!! Never cover the generator when it is running. The cut-out mounted on the generator has the aimed of reducing the risk of

electric shock. If it needs to be replaced with another cut-out, the latter must correspond to the technical specifications of the generator. Due to important mechanical constraints, it is necessary to use a flexible sheathed cable with a strong rubber protective layer (conforming to IEC 245-4) or a similar cable. If using an electrical extension cable, the total length of the extension must not exceed 60m when the section of the wire is 1.5mm² and must not exceed 100m when the section of the wire is 2.5mm².

Additional requirements for low-power generating sets for use by laymen

- Protect children by keeping them at a safe distance from the generating set.
- Fuel is combustible and easily ignited. Do not refuel during operation. Do not refuel while smoking or near naked flames. Do not spill fuel.
- Some parts of the internal combustion engine are hot and may cause burns. Pay attention to the warnings on the generating set.
- Engine exhaust gases are toxic. Do not operate the generating set in unventilated rooms. When installed in ventilated rooms, additional requirements for fire and explosion protection shall be observed.
- Before use, the generating set and its electrical equipment (including lines and plug connections) should be checked to ensure that they are not defective.
- Protection against electrical shock depends on circuit breakers specially matched to the generating set. If the circuit breakers require replacement, they should be replaced with a circuit breaker having identical ratings and performances characteristics.

- Due to high mechanical stresses, only tough rubber-sheathed flexible cable (in accordance with IEC 60245-4) or the equivalent should be used.
- The user shall conform to regulations of electrical safety applicable to the place where the generating sets are used.
- The user must respect the requirements and precautions in the case of resupply by generating sets of an installation, depending on existing protective measures in this installation and applicable regulations.
- Generating sets should only be loaded up to their rated power under the rated ambient conditions.
- Prior to commencing maintenance work it shall be ensured that untimely start-up is not possible.

Security measures when filling the fuel tank

- The fuel is extremely flammable and poisonous.
- This generator only uses petrol (gasoline); any other kind of fuel will damage the motor.
- Do not overfill the tank with petrol to avoid spilling. If you notice a spill, it must be wiped up completely with a dry cloth before starting the motor.
- If you swallow fuel by mistake, if you inhale fuel vapors or if you get drops of fuel in your eyes, see a doctor immediately. If a certain quantity of fuel is spilt on your skin or clothing, wash or change your clothes.
- Always stop the motor of the generator when filling it with fuel.

- Never fill the fuel tank while smoking or near a naked flame.
- Make sure you don't spill fuel on the motor and the exhaust grille of the generator during filling with fuel.
- Keep the fuel in an appropriate recipient and sheltered from any sources of fire.
- Carry out filling in a safe place, and slowly open the fuel cap to release the pressure which has built up inside the tank. Wipe up any drops of petrol that have spilled before starting the motor.
- To prevent fire, move the generator at least 4 meters away from the area for filling with fuel.
- Make sure that the fuel cap is tightly closed before starting.
- Do not keep petrol in the tank for a long time.



- While using or transporting the generator, make sure you keep the generator upright, otherwise the fuel may escape from the carburetor or the fuel tank.



Electrical safety

- Before each use ensure that the load to be connected does not exceed the power of the current produced by the generator.

To avoid electric shock, you must follow the following instructions:

- Do not touch the generator with wet hands.

- Do not run the generator under rain or snow.
- Do not run the generator near water.
- Connect the generator to earth. Use a sufficiently thick conductor for the earth wire.
- Do not operate the generator in parallel with another generator.
- If using electrical extensions, make sure that they are sufficiently thick to transport the current and that they are used correctly.



- The connection of a generator used for auxiliary power to the electrical installation of a building must be performed by a qualified electrician, and in conformity to the provisions of the applicable laws and norms in the field of electricity. Incorrect connections will cause leakage of the current from the generator into the lines of the public electricity company. Such leakage could electrocute the workers of the public electricity company working on the network or other persons in contact with the line during a power cut. Also, when the public power supply is re-established, the generator can explode, catch fire or generate fires in the building's electrical installation.



Before connecting electrical devices to the generator, make sure that their voltage specifications and frequency of functioning correspond to the technical characteristics of the generator. There may be damage if the

device connected is not designed to function with a voltage tolerance of +/- 10% or a frequency tolerance of +/- 3 % compared with those of the generator.

Protection of the environment

- You must periodically check the silencer (Before doing this, switch off the generator and let it cool completely). A damaged silencer increases noise.
- Do not throw motor oil into the drains but deposit it at a collection point set up for that purpose.
- The fuel for this machine is combustible and explosive. After stopping the machine, you must handle the remaining fuel correctly and meet local environmental requirements.

To use the WIFI function please read the additional manual provided with this one.

3. UNIT DESCRIPTION

3.1 COMPONENTS IDENTIFICATION



(1). Control Panel: Location of generator controls and output receptacles.

- (2). Fuel Cap: Access to fuel tank for filling.
- (3). Fuel Cap Vent Lever: Control valve between atmosphere and fuel tank.
- (4). Carrying Handle: Lift the generator by this handle only.
- (5). Starter Grip: Pull starter grip for starting engine.
- (6). Choke Knob: Cold engine starting aid.
- (7). Wheels: Move the generator by the wheels.
- (8). Draw Bar Handle: Pull the handle to drag this generator on the ground.
- (9). Maintenance Cover: Allows access to air filter, carburetor and engine oil cap etc.
- (10). Spark Plug Maintenance Cover: Allows access to engine spark plug.
- (11). Oil Maintenance Cover: Allows access to fill the engine oil.
- (12). Fuel Gauge: Check fuel level in fuel tank.
- (13). Muffler: Lowers engine exhaust noise.
- (14). Air Filter: Clean air for engine.
- (15). Carburetor: Supply the fuel-air mixture to engine.
- (16). Spark Plug: Ignites the fuel-air mixture when the engine piston reaches the top of the cylinder.
- (17). Oil Cap: Access to fill or drain engine oil.
- (18). Air Intake Slats: Allow for cooling air to enter the housing.

3.2 CONTROL PANEL

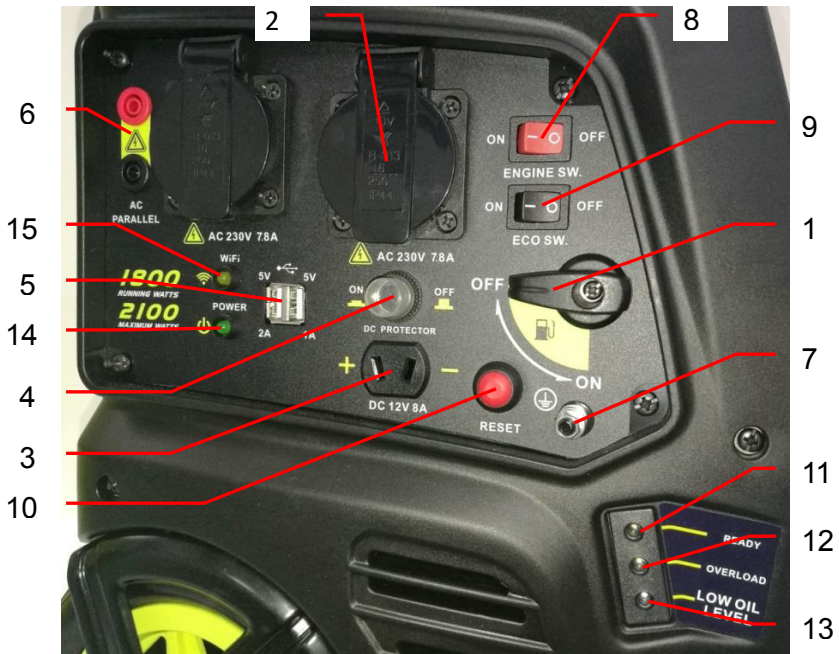

- (1). Fuel Tap: Controls fuel supply to the carburetor.
- (2). AC Receptacles: AC Output receptacles for connecting AC devices.
- (3). 12V DC Receptacle: Connection for re-charging 12V DC automotive-style batteries while generator is in operation.
- (4). 12V DC Circuit Breaker: Overload protection for the 12VDC charging system.
- (5). USB Plug: USB Output receptacles for connecting 5VDC devices.
- (6). Parallel Terminal (optional): AC Parallel operation outlets for the same two generators.
- (7). Ground (Earth) Terminal: Grounding point for the generator.
- (8). Engine Switch: This switch turns ON or OFF engine ignition system.

- (9). ECO Switch: Turning on this switch can slow the engine speed when the load is reduced to save fuel, lessen noise and engine wear.
- (10). Reset Button: This switch can be used to recover output of the generator under the condition of overload protection, and unnecessary to restart engine overall.
- (11). READY LED (green): READY LED light comes ON when the generator is operating normally. It indicates that the generator is producing electrical power at the receptacles.
- (12). OVERLOAD LED (red): If the generator is overloaded, or if there is a short circuit at AC receptacles, the overload LED light (red) will go ON, and current to the connected appliance(s) will shut off in a few seconds.
- (13). LOW OIL LEVEL LED (yellow): Lights up when oil level is below safe operating level and the engine shuts down automatically. Unless you refill with oil, the engine will not start again.
- (14). POWER LED (optional): Lights up when the Gen-mate unit (optional equipment) inside the generator is operating normally.
- (15). Wi-Fi LED (optional): The light comes ON and flash slowly when the generator with Gen-mate unit (optional equipment) is connected to the Gen-mate APP in Smartphone by Wi-Fi.

4. PREPARATION

4.1 ENGINE OIL

NOTE

- **The engine has been shipped from our factory without oil. Put oil before starting.**
- **Recommended engine oil: 4-stroke engine oil, SAE 10W-40, API SE/SF/SG/SH/SJ or higher.**
- **Engine oil quantity: 0.4L.**

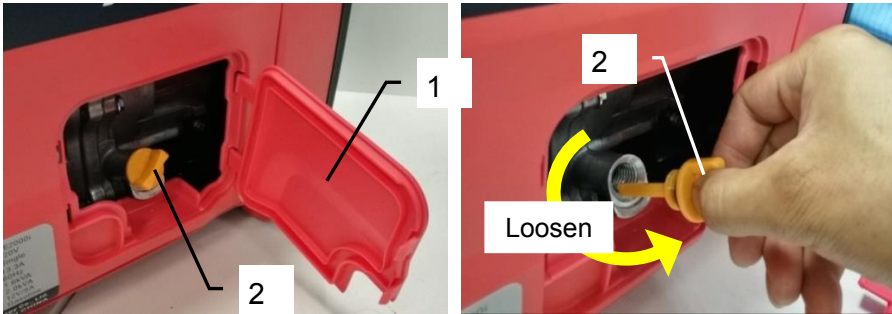

Add Engine Oil:

- (1). Open the Oil Maintenance Cover 1, and remove the Oil Cap 2.
- (2). Fill the specified amount of the recommended engine oil, and then install and tighten the Oil Cap.

NOTE

- **Make certain the generator is on a flat, level surface.**
- **Keep the engine oil level between LOWER LIMIT and UPPER LIMIT. Too much or too little oil will shorten the service life of the engine.**

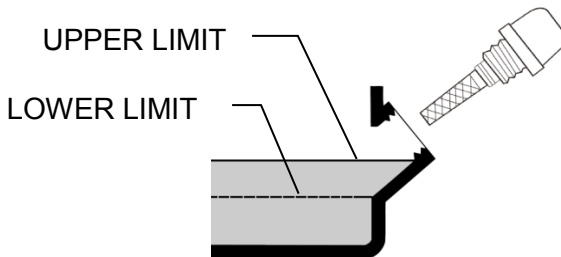

- **The engine is equipped with a low oil sensor that will prevent the engine from running. If the oil level falls below a critical threshold, the engine will stop automatically.**
- **When the engine shuts down automatically by the low oil protection, the LOW OIL LEVEL LED (yellow) will come on, and unless you refill with oil, the engine will not start again.**

4.2 FUEL

⚠ WARNING

- **Gasoline is extremely flammable and explosive under certain conditions. Do not smoke or allow flames or sparks where the generator is refueled or where gasoline is stored.**
- **Refuel in a well-ventilated area with the engine stopped.**
- **DO NOT fill above the Red Level, otherwise it may overflow when the fuel warms up and expands.**
- **Immediately wipe off spilled fuel with a clean, dry, soft cloth, since fuel may deteriorate painted surfaces or plastic parts.**

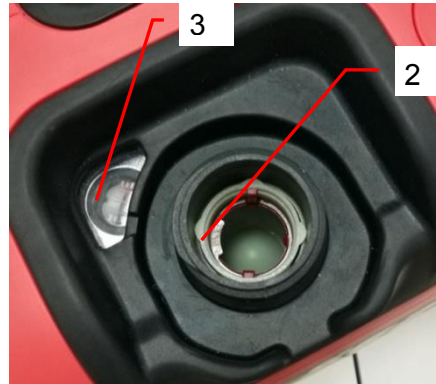

Add Fuel:

- (1). Remove the Fuel Cap 1 and fill the fuel into the tank up to the Red Level 2.
- (2). the fuel level in the fuel tank can be checked through the Fuel Gauge 3.
- (3). after fill the fuel, make sure the Fuel Cap 1 is tightened securely.

NOTE

- **Use only unleaded gasoline. The use of leaded gasoline will cause severe damage to internal engine parts.**
- **Never use an oil/gasoline mixture.**

- You may use regular unleaded gasoline containing no more than 10% Ethanol (E10).
- Make certain the generator is on a flat, level surface.
- Fuel tank capacity: 4.2L.

5. STARTING THE ENGINE

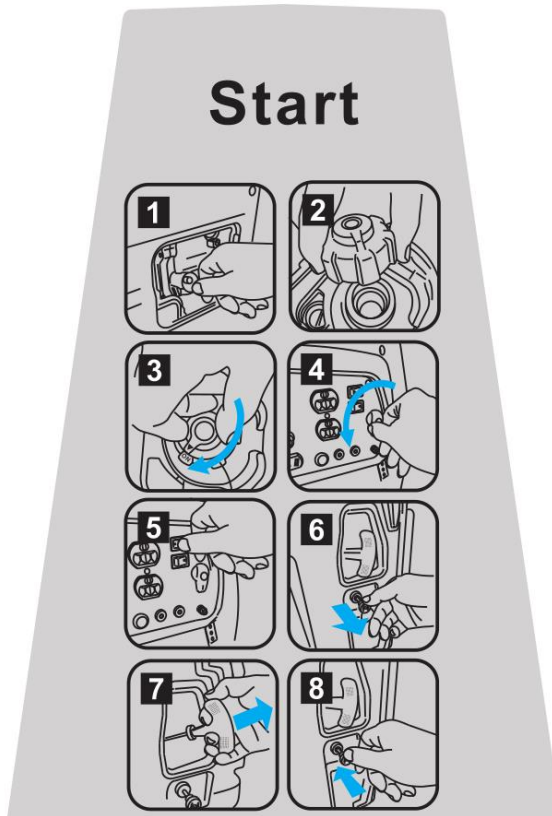

5.1 CHECK ENGINE OIL

Check the oil BEFORE EACH USE with the generator on a level surface and the engine stopped.

RECOMMENDED OIL:

4-stroke engine oil, SAE 10W-40, API SE/SF/SG/SH/SJ or higher.

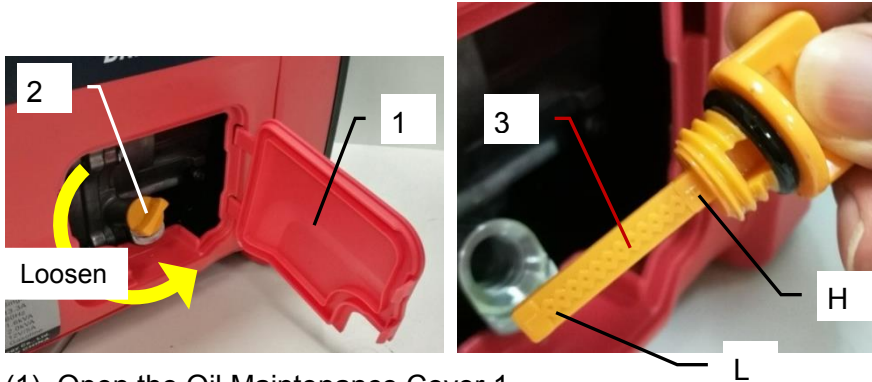

(1). Open the Oil Maintenance Cover 1.

(2). Remove the Oil Cap 2 and wipe the Dipstick 3 clean.

(3). Check the oil level by inserting the Dipstick 3 into the filler neck without screwing it in.

(4). If the wet line on the Dipstick 3 is between "L" position and "H" position, the oil level is OK. If the oil cannot reach "L" position, the oil level is too low. Fill to the upper limit of the oil filler neck with the recommended oil.

(5). Tighten the Oil Cap 2 and reinstall the Oil Maintenance Cover 1.

(6). Check generator for oil leakage.

NOTE

- **Make certain the generator is on a flat, level surface when check the engine oil.**
- **The engine is equipped with a low oil sensor that will stop the engine automatically when the oil level falls below a critical threshold.**

- When the engine shuts down automatically by the low oil protection, the LOW OIL LEVEL LED (yellow) will come on, and unless you refill with oil, the engine will not start again.

5.2 CHECK FUEL

⚠ WARNING

- Do not smoke or allow flames or sparks where the generator is refueled or where gasoline is stored.
- Refuel in a well-ventilated area with the engine stopped.
- DO NOT fill above the Red Level.

Check the fuel BEFORE EACH USE with the generator on a level surface and the engine stopped.

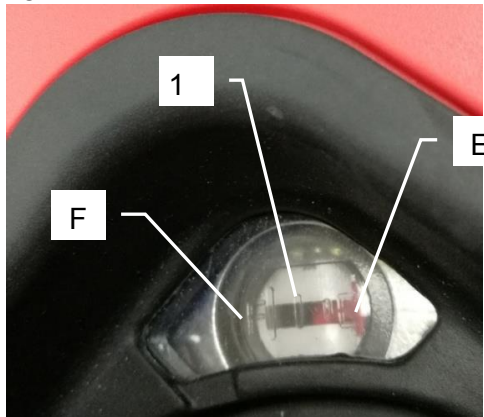

- (1). Checked the fuel level in the fuel tank through the Fuel Gauge 1. If the red mark in the Fuel Gauge 1 is close to "E" position, means the fuel level in the fuel tank is lower. If the red mark in the Fuel Gauge 1 is close to "F" position, means the fuel level in the fuel tank is higher.
- (2). Refuel if necessary.
- (3). after fill the fuel, make sure the Fuel Cap is tightened securely.
- (4). Check generator for fuel leakage.

NOTE

- Use only unleaded gasoline.
- Never use an oil/gasoline mixture.
- Fuel tank capacity: 4.2L.
- Make certain the generator is on a flat, level surface when check the fuel.

5.3 OPEN THE FUEL CAP VENT LEVER



Turn the Fuel Cap Vent Lever 1 to "ON" position.

"ON" position

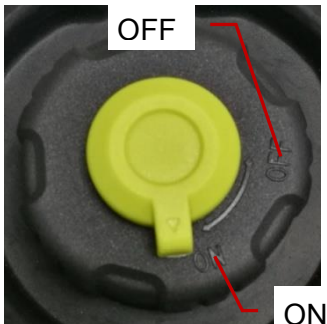

"OFF" position

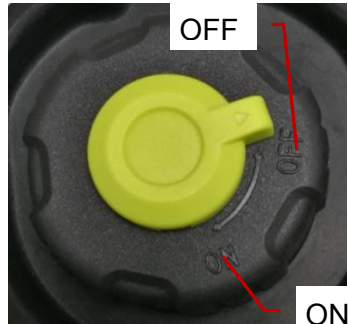

5.4 OPEN THE FUEL TAP



Turn the Fuel Tap 1 to "ON" position.

"ON" position



"OFF" position



5.5 THE ENGINE SWITCH & ECO SWITCH

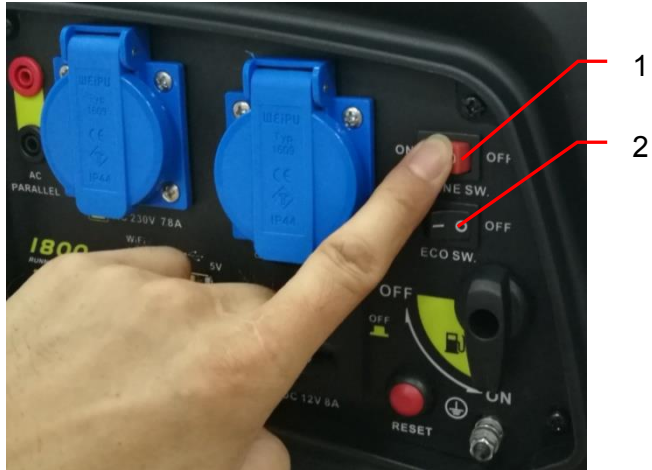

(1). Turn the Engine Switch (Red) 1 to “ON” position.

(2). Turn the ECO Switch (Black) 2 to “OFF” position.

“ON” position



“OFF” position



5.6 USE CHOKE



Pull the Choke Knob 1 fully out to "START" position.

"RUN" position



"START" position



NOTE

- The Choke is not required to start a warm engine. Push the Choke Knob into the "RUN" position.
- Keep the Choke Knob in "START" position for only 2 pulls of the recoil starter. After second pull, push Choke Knob into the "RUN" position for up to the next 3 pulls. Too much choke leads to Spark Plug fouling/engine flooding due to the lack of incoming air. This will cause the engine not to start.

5.7 START THE ENGINE

⚠ DANGER

- Exhaust fumes contains poisonous carbon monoxide (CO) , a colorless and odorless gas. Breathing CO can cause loss of consciousness and may lead to death.
- Operate the generator in a well-ventilated area. Never run your generator inside a garage or house, even if door or window is open.



Start The Engine:

Pull the Starter Grip 1 slowly until resistance is felt and then pull rapidly.

NOTE

- Make certain the generator is on a flat, level surface when start or operate the generator.
- Turn off or unplug all electrical loads connected to the generator AC Receptacles before starting the engine.
- Do not allow the Starter Grip to snap back against the generator. Return it gently to prevent damage to the starter or housing.

- Normally the engine can be started within three pulls. Keep the Choke Knob in "START" position for only 2 pulls. After second pull, push the Choke Knob into the "RUN" position for up to the next 3 pulls.

5.8 CLOSE CHOKE



After starting the engine, push the Choke Knob 1 fully into the "RUN" position.

"RUN" position



"START" position

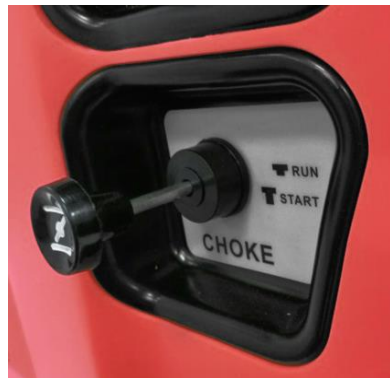

NOTE

Wait a few seconds until the engine speed is stable before closing the choke, and more time waiting if weather is cold.

6. AC OPERATION

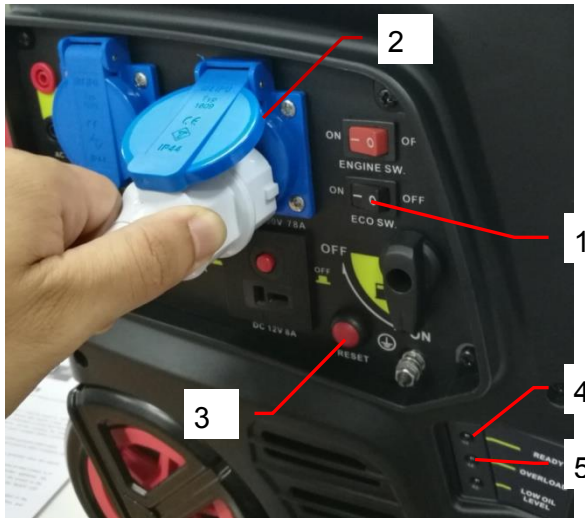

6.1 USE THE GENERATOR:

After starting the engine, let it run for 2 or 3 minutes to warm up, then you can use the generator as follows:

- (1). Make sure the READY LED (green) 4 comes on.
- (2). Turn the ECO Switch 1 to "ON" position to use Economy Control System. This system controls the engine speed according to the connected load. The results are better fuel consumption and less noise.
- (3). Connect plug to the generator AC Receptacles 2 for AC electric devices.
- (4). Turn on the electric devices for operation.

"ON" position

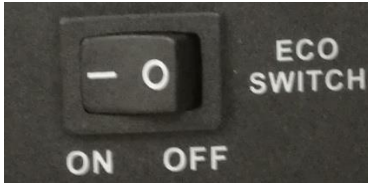

"OFF" position

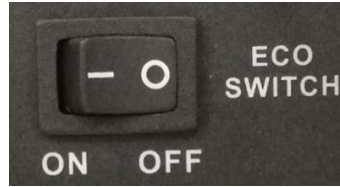

⚠ WARNING

Be sure any electric devices are turned off before plugging them in.

NOTE

- The ECO Switch 1 must be turned to "OFF" position when using electric devices that require a large starting current, such as a heavy compressor or some high electrical loads.
- Be sure all electric devices including the lines and plug connections are in good condition before connection to the generator.
- Be sure the total load is within generator rated output.
- Be sure the receptacle load current is within receptacle rated current.
- Be sure to ground (Earth) the generator when the electric device is earthed.
- If the generator is overloaded (in excess of rated power), or if there is a short circuit in a connected appliance, the OVERLOAD LED (red) 5 will go ON, and the current to the connected appliance(s) will shut off, and the READY LED (green) 4 will go OFF.
- The Reset Button 3 can be used to recover output of the generator under the condition of overload protection, and unnecessary to restart engine overall. But at first check and correct the problem, if there is a short circuit in a connected

appliance or wire.

- When an electric motor is started, the OVERLOAD LED (red) 5 may come on. This is normal if the OVERLOAD LED (red) 5 goes off after a few seconds.

6.2 SHUT DOWN THE GENERATOR:

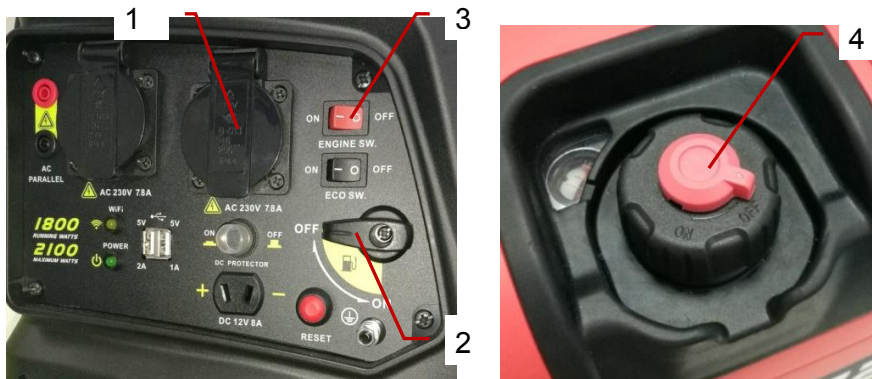
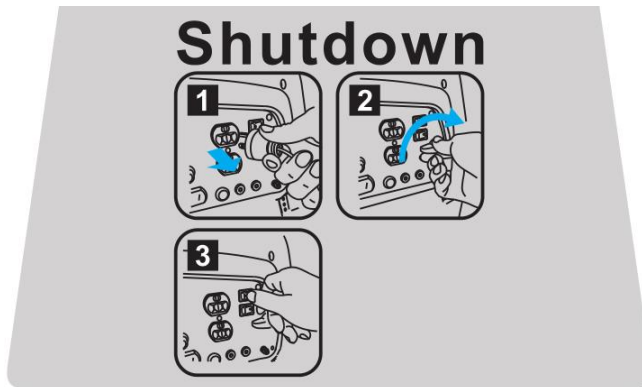

Once the generator is no longer needed it can be shut down:

- (1). Disconnect or turn off all electrical loads connected to the generator AC Receptacles 1.
- (2). Turn the Fuel Tap 2 to the "OFF" position.

(3). Turn the Engine Switch 3 to "OFF" position.

(4). Allow the engine to cool well, and then turn the Fuel Cap Vent Lever 4 to "OFF" position.

"ON" position



"OFF" position



"ON" position



"OFF" position



"ON" position

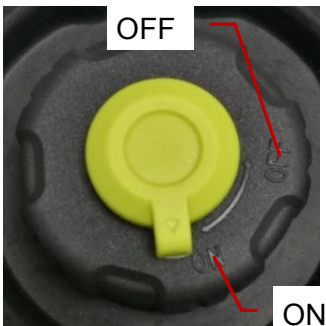

"OFF" position

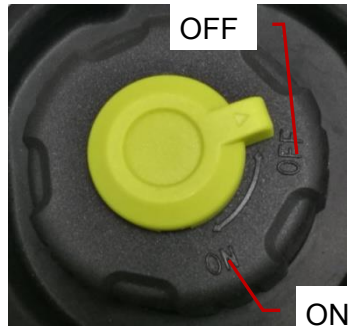

NOTE

- **TURN OFF** all electrical loads connected to the generator AC Receptacles 1 before shutting down by Gen-mate APP in smartphones.
- If shutting down by Gen-mate APP in smartphones, the above step 2/3 is unnecessary, and step 4 should be done before moving or storing the generator.

⚠ WARNING

- Always allow the generator to cool off before moving or storing. High temperatures will be present at the rear of the unit for some time after shutdown.
- **DO NOT** turn the Fuel Cap Vent Lever 4 to “OFF” position before cooling the engine. Allow the engine to cool well, if not, the fuel tank can be crushed by cold contraction of the fuel gas in the fuel tank.

7. DC OPERATION

⚠ WARNING

- Never smoke, open flame sparks or make and break connections at the battery while charging. Sparks may ignite the battery gas. Batteries give off explosive hydrogen gas while recharging. Provide adequate ventilation when charging or using batteries.
- Wear protective goggles and gloves when working around a battery. Battery electrolyte is an extremely corrosive sulfuric acid solution that can cause severe burns. Avoid contact with skin, eyes or clothing. If a spill occurs, flush area with clear water immediately.

7.1 CONNECTING THE BATTERY CHARGING CABLE:

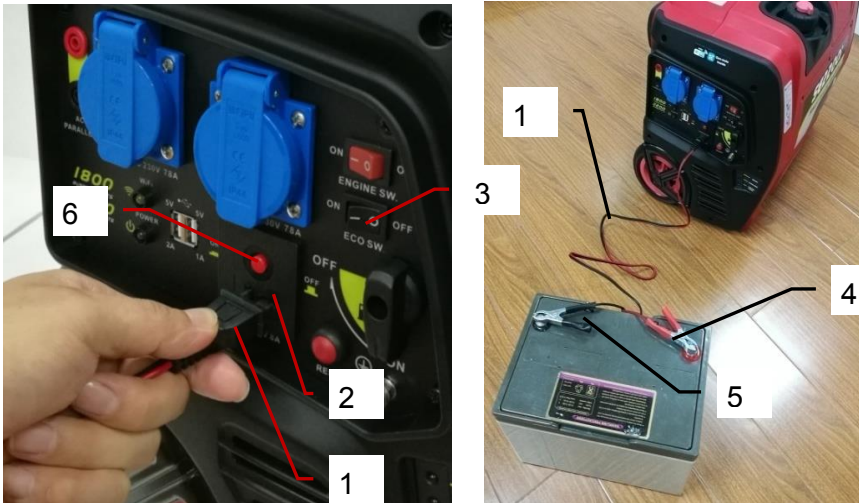

- (1). before connecting the Battery Charging Cable 1 to a battery that is installed in a vehicle, disconnect the vehicle battery ground cable from the negative (-) battery terminal.
- (2). Plug the Battery Charging Cable 1 into the 12V DC Receptacle 2 of the generator.
- (3). Connect the Red Charger Jack 4 to positive (+) battery terminal and the Black Charger Jack 5 to negative (-).
- (4). Turn the ECO Switch 3 to the “OFF” position.
- (5). Start the engine to charge the battery.
- (6). Charging time will vary with battery size and condition. The DC Circuit Breaker 6 does not prevent over-charging a battery.

NOTE

- The 12V DC Receptacle should **ONLY** be used for charging 12V automotive type batteries. The 12V DC output is unregulated and will damage other 12V DC products.
- When using the 12V DC output, turn the ECO Switch to the “OFF” position.

- **NEVER** reverse the polarity when connecting the battery terminals to the charging jack. Severe damage may occur to the generator and battery.
- Do not start the vehicle while the battery charging cable is connected and the generator is running. The vehicle or the generator may be damaged.
- An overloaded DC circuit or a wiring problem will trip the DC Circuit Breaker 6(PUSH button extends out). If this happens, wait a few minutes before pushing in the DC Circuit Breaker 6 to resume operation. If the DC Circuit Breaker 6 continues to go OFF, discontinue charging and contact your authorized generator dealer.

7.2 DISCONNECTING THE BATTERY CHARGING CABLE:

- (1). Turn the Engine Switch to “OFF” position to stop the engine.
- (2). Disconnect the Black Charger Jack of the Battery Charging Cable from the negative (-) battery terminal.
- (3). Disconnect the Red Charger Jack of the Battery Charging Cable from the positive (+) battery terminal.
- (4). Disconnect the Battery Charging Cable from the 12V DC Receptacle of the generator.
- (5). Connect the vehicle battery ground cable to the negative (-) battery terminal.

8. AC PARALLEL OPERATION

Two EZG2000i generators can be operated in parallel to increase the total available output power reach 3.6 kW. A Parallel Kit 2(optional equipment) is required for the parallel operation.

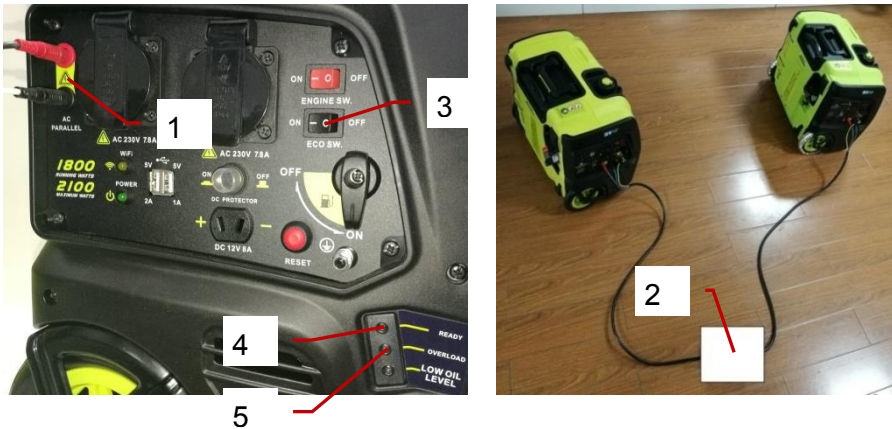

8.1 START AC PARALLEL

- (1). Disconnect or turn off all electrical loads from both generators.
- (2). Connect the Parallel Kit 2 between the two EZG2000i generators Parallel Terminal 1.
- (3). Start the engines and make sure the READY LED (green) comes on.
- (4). Plug the appliance in receptacles of the Parallel Kit 2.
- (5). Turn on the appliance to use.

NOTE

- Never connecting the generator in parallel with any other generator.
- Never connect or remove the Parallel Kit 2 when the generator is running.
- For single generator operation, the Parallel Kit 2 must be

removed.

- If an appliance begins to operate abnormally, becomes sluggish or stops suddenly, turn it off immediately. Then disconnect the appliance from receptacles of the Parallel Kit 2, and determine whether the problem is the appliance, or if the rated load capacity of the generator has been exceeded.
- The ECO Switch 3 must be in the same position on both generators.
- Make sure that the electrical appliance rated power does not exceed the total rated power of two generators.
- Most motorized appliances require more than their rated wattage for startup. When an electric motor is started, the OVERLOAD LED (red) 5 may come on. This is normal if the OVERLOAD LED (red) 5 goes off after a few seconds.
- If the generators are overloaded, or if there is a short circuit in a connected appliance, the OVERLOAD LED (red) 5 will go on, and the current to the connected appliances will shut off, and the READY LED (green) 4 will go off. Stop the engines and investigate the problem.

8.2 STOP AC PARALLEL

Once the generators are no longer needed they can be shut down:

- (1). Disconnect or turn off all electrical loads from receptacles of the Parallel Kit 2.
- (2). Stop the engine one by one as follows:
 - Turn the Fuel Tap to the “OFF” position.
 - Turn the Engine Switch to “OFF” position.
- (3). Allow the generator to cool before moving or storing.

NOTE

TURN OFF all electrical loads connected to receptacles of the Parallel Kit 2 before shutting down by Gen-mate APP in smartphones.

9. SPECIAL REQUIREMENTS

NOTE

- **DO NOT** modify the generator in any way.



- The generator is allowed to be put down, but **ONLY** lay on the Drawbar Side 1. If lay down on other side, OIL may leak and damage the engine or your property. Also FUEL may leak and cause FIRE or an EXPLOSION.
- Stop the engine and **TURN OFF** the Fuel Tap before putting down the generator.
- Before transporting and storing the generator, proceed as follows:
 - (1). Turn OFF the Fuel Tap.
 - (2). Allow the generator to cool off before moving or storing.

(3). Close the Fuel Cap tightly.

(4). Turn OFF the Fuel Cap Vent Lever.

- DO NOT turn the Fuel Cap Vent Lever to “OFF” position before cooling the engine. Allow the engine to cool well, if not, the fuel tank can be crushed by cold contraction of the fuel gas in the fuel tank.
- Keep all cooling holes open and clear of debris, mud, water, etc. Cooling holes are located on the front panel and the back cover of generator. If the cooling holes are blocked, the generator may overheat and damage the engine, inverter, or windings.
- DO NOT remove any cover of the Generator Case 1 when the engine is running. If not, inverter or other electric parts may be damaged because of bad cooling.

10. MAINTENANCE

Periodic maintenance will keep your generator in the best operating condition.

WARNING

- Read the instructions before you begin, and make sure you have the tools and skills required.
- Stop the engine before starting maintenance work.
- To reduce the possibility of fire or explosion, be careful when working around gasoline. Use only a nonflammable solvent, not gasoline, to clean parts. Keep cigarettes, sparks, and flames away from all fuel-related.

NOTE

- If you are not familiar with maintenance work, have an authorized dealer do it for you.

- Use ours or equivalent quality parts for replacement. Ask an authorized dealer for further attention.



Maintenance Schedule

Regular Service Period (5)		Item	Each use	Every 6 months or 50 hrs.	Every 1 year or 100 hrs.	Every 2 years or 300 hrs.
Engine oil	Check level	⊙				
	Change		⊙(1)			
Air cleaner	Clean			⊙(2)		
Spark plug	Check-adjust			⊙		
	Replace					⊙
Spark arrester	Clean			⊙		
Valve Clearance	Check-adjust					⊙(3)
Combustion Chamber	Clean					⊙(3)
Fuel tank & filter	Clean			⊙		
Fuel line	Check					⊙(4)

NOTE

- (1). Change engine oil after the first 10 hrs.
- (2). Service more frequently when used in dusty areas.
- (3). these items should be serviced by your servicing dealer, unless you have the proper tools and are mechanically proficient.
- (4). Replace fuel line if necessary every 2 years.
- (5). for commercial use, long hours of operation to determine proper maintenance intervals. Failure to follow this maintenance

schedule could result in non-warrantable failures.

10.1 ENGINE OIL CHANGE

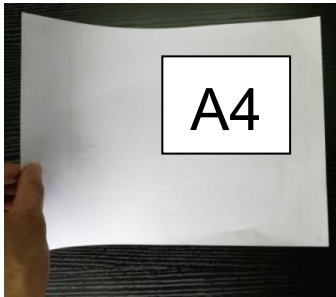
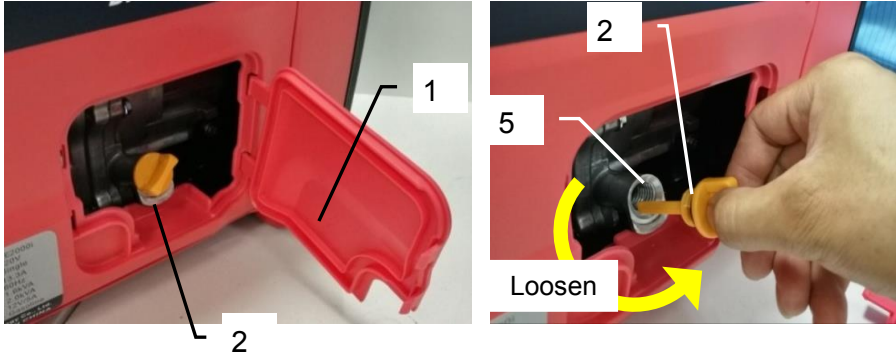

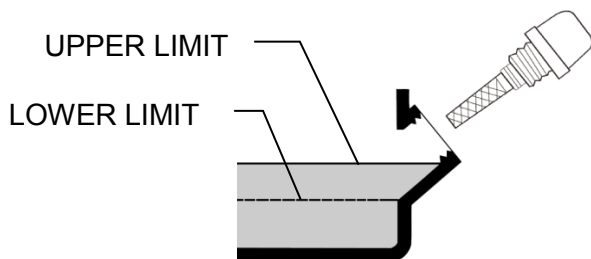
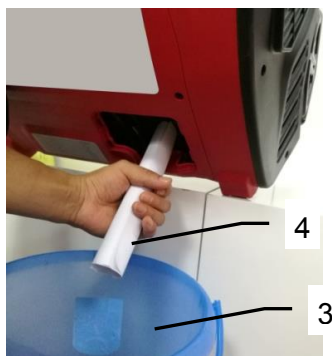
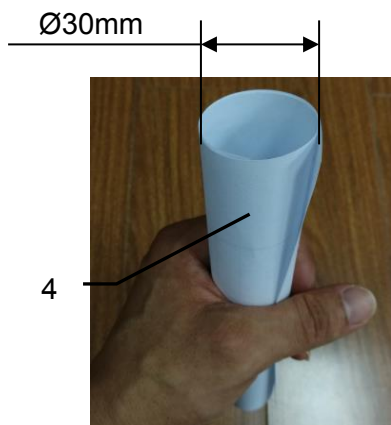

Drain the used oil while the engine is warm. Warm oil drains quickly and completely.

(1). Turn OFF the Fuel Tap, Close the Fuel Cap tightly and turn OFF the Fuel Cap Vent Lever to reduce the possibility of fuel leakage.

(2). Open the Oil Maintenance Cover 1.

(3). Place a suitable Container 3 next to the engine to catch the used oil.

(4). Remove the Oil Cap/Dipstick 2, and use a A4 paper to make a Pipe 4 that its diameter is about 30mm.

(5). Set fully the paper Pipe 4 outside of the Oil Filler Neck 5, and drain the used oil into the Container 3 by tipping the engine toward the Oil Filler Neck 5.

(6). with the engine in a level position, fill to the UPPER LIMIT of the Oil Filler Neck 5 with the recommended oil.

(7). Reinstall the Oil Cap/Dipstick 2 securely.

(8). Reinstall the Oil Maintenance Cover 1.

NOTE

- Do not tilt the generator when adding engine oil. This could result in overfilling and damage to the engine.
- Improper disposal of engine oil can be harmful to the environment. The used oil should be put in a sealed container, and take it to a recycling station. Do not discard it in a trash bin, dump it on the ground, or pour it down a drain.

10.2 AIR CLEANER SERVICE

A dirty air cleaner will restrict air flow to the carburetor. To prevent carburetor malfunction, service the air cleaner regularly. Service more frequently when operating the generator in extremely dusty areas.

⚠ WARNING

Using gasoline or flammable solvent to clean the air filter can cause a fire or explosion. Use only soapy water or nonflammable solvent.

NOTE

Operating the engine without an air filter, or with a damaged air filter, will allow dirt to enter the engine, causing rapid engine wear. This type of damage is not covered by the Distributor's Limited Warranty.

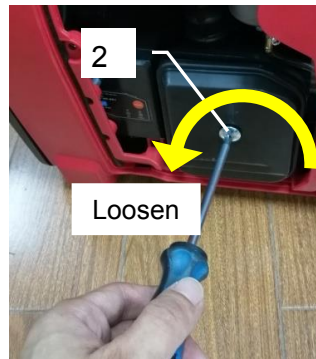

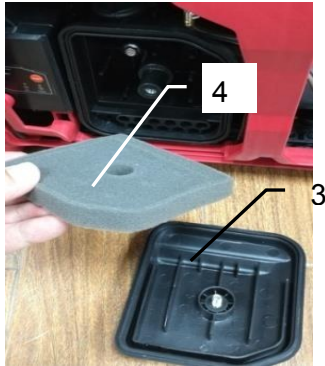

- (1). Loosen five screws and remove the Maintenance Cover 1.
- (2). Loosen the Cover Screw 2 and remove the Air Filter Cover 3.
- (3). Wash the Sponge 4 in a solution of household detergent and warm water, then rinse thoroughly, or wash in nonflammable or high flash point solvent. Allow the air filters to dry thoroughly.
- (4). Reinstall the Sponge 4 and Air Filter Cover 3, and tighten the Cover Screw 2.
- (5). Reinstall the Maintenance Cover 1.

10.3 SPARK PLUG SERVICE

NOTE

- **Recommended spark plug: A5RTC (TORCH)**
- **To ensure proper engine operation, the spark plug must be properly gapped and free of deposits.**
- **An incorrect spark plug can cause engine damage.**
- **If the engine has been running, allow it to cool before servicing the spark plug.**

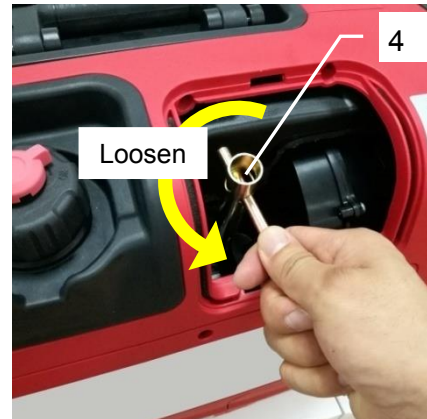
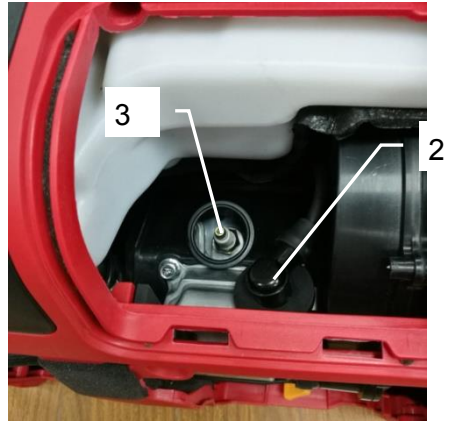

- (1). Unscrew the screw 5, and then remove the Spark Plug Maintenance Cover 1.
- (2). Remove the Spark Plug Cap 2.
- (3). Use a Spark Plug Wrench 4 to remove the Spark Plug 3.
- (4). Inspect the Spark Plug 3. Replace it if the electrodes are worn or if the insulator is cracked, chipped, or fouled.
- (5). Measure the spark plug electrode gap with a wire-type feeler gauge. Correct the gap, if necessary, by carefully bending the side electrode. The gap should be: 0.024–0.028 in (0.60–0.70 mm)

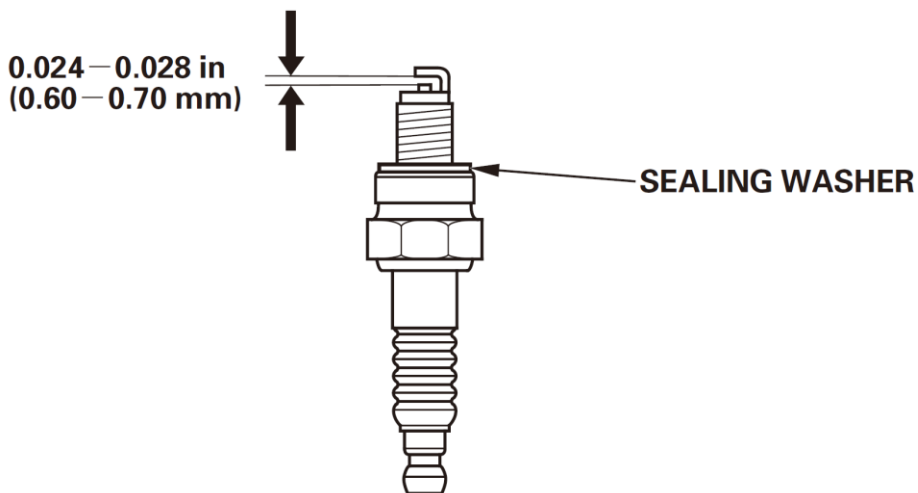

- (6). Check that the spark plug sealing washer is in good condition.
- (7). After the Spark Plug 3 is seated; tighten with a Spark Plug Wrench to compress the washer. If installing a new spark plug, tighten 1/2 turn after the spark plug seats to compress the washer. If reinstalling a used spark plug, tighten 1/8 – 1/4 turn after the spark plug seats to compress the washer.
- (8). Reinstall the Spark Plug Cap 2 on the Spark Plug 3 securely.
- (9). Reinstall the Spark Plug Maintenance Cover 1.

NOTE

A loose spark plug can overheat and damage the engine. Over tightening the spark plug can damage the threads in the cylinder head.

10.4 SPARK ARRESTER MAINTENANCE

NOTE

- **If the generator has been running, the muffler will be very hot. Allow it to cool before proceeding.**

- The Spark Arrester must be serviced every 100 hours to maintain its efficiency.

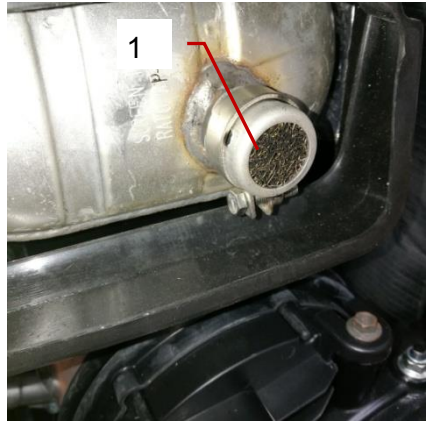
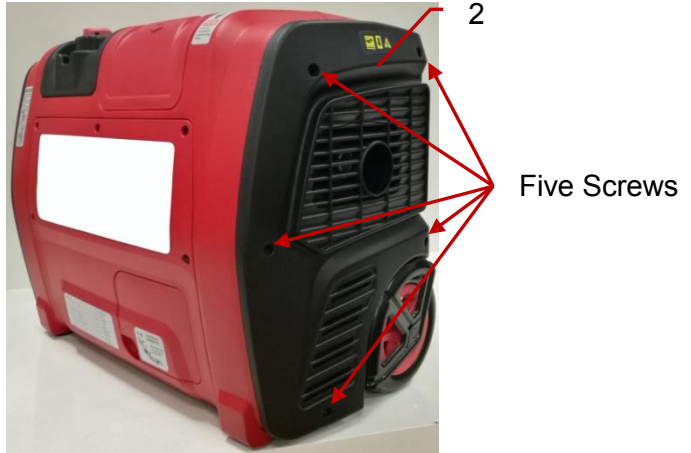

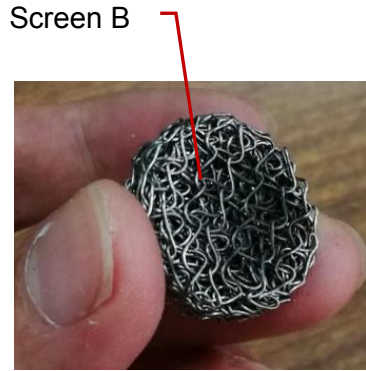
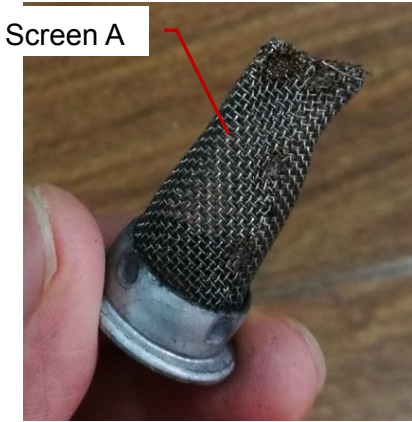

Clean the Spark Arrester 1 as follows:

- (1). Remove the five screws, and remove the Back Cover 2.
- (2). Remove the Spark Arrester 1.
- (3). Use a brush to remove carbon deposits from the Screen A and B.
- (4). Inspect the Screen A for breaks or tears and replace it if necessary.
- (5). Reinstall the Spark Arrester 1, and the Back Cover 2.

10.5 CLEANING FUEL TANK FILTER

⚠ WARNING

Never use the gasoline while smoking or in the vicinity of an open flame.

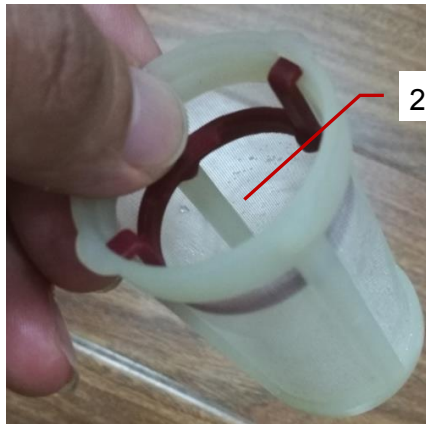
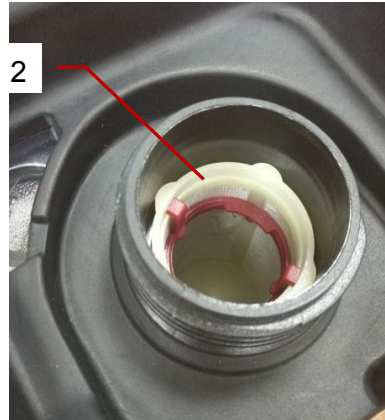

- (1). Remove the Fuel Cap 1 and Fuel Tank Filter 2.
- (2). Clean the Fuel Tank Filter 2 with gasoline. If damaged, replace it.
- (3). Wipe the Fuel Tank Filter 2 and install it.
- (4). Install the Fuel Cap 1 securely.

11. TRANSPORTATION AND STORAGE

⚠ WARNING

- Transport or store the generator only if it has cooled completely.
- Before transporting and storing the generator, proceed as follows:
 - (1). Turn OFF the Fuel Tap.
 - (2). Allow the generator to cool off before moving or storing.
 - (3). Close the Fuel Cap tightly.
 - (4). Turn OFF the Fuel Cap Vent Lever.
- DO NOT turn the Fuel Cap Vent Lever to “OFF” position before cooling the engine. Allow the engine to cool well, if not, the fuel tank can be crushed by cold contraction of the fuel gas in the fuel tank.

It is important to prevent gum deposits from forming in essential fuel system parts such as the carburetor, fuel hose or tank during long-term storage.

If the generator is going to be stored for more than six (6) months, the generator should be prepared as follows:

11.1 DRAIN THE FUEL FROM THE CARBURETOR

"ON" position

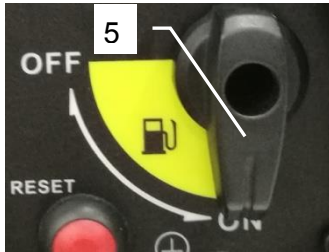

"OFF" position

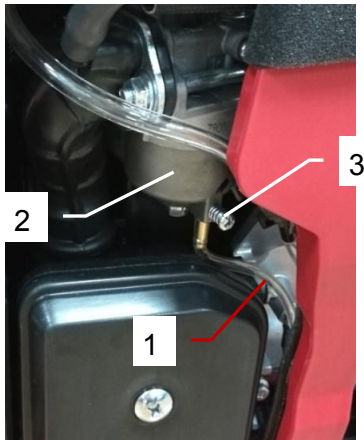

- (1). Turn the Fuel Tap 5 to the “OFF” position.
- (2). Loosen five screws and remove the Maintenance Cover 4.
- (3). Take out the Drain Hose 1 from the hole at the bottom casing, and put it into a suitable container.
- (4). Loosen the Drain Screw 3 anticlockwise.
- (5). Drain the gasoline from the Carburetor 2 into the container through the Drain Hose 1.
- (6). Tighten the Drain Screw 3 clockwise securely.

11.2 DRAIN THE FUEL FROM FUEL TANK



- (1). Unscrew the Fuel Cap, remove the Fuel Tank Filter.
- (2). Empty the fuel tank into the suitable container by slowly tipping the generator toward the Fuel tank Neck 1.
- (3). Reinstall the Fuel Tank Filter and the Fuel Cap.
- (4). Tighten clockwise the Fuel Cap securely.

11.3 DRAIN THE FUEL FROM THE CARBURETOR AGAIN

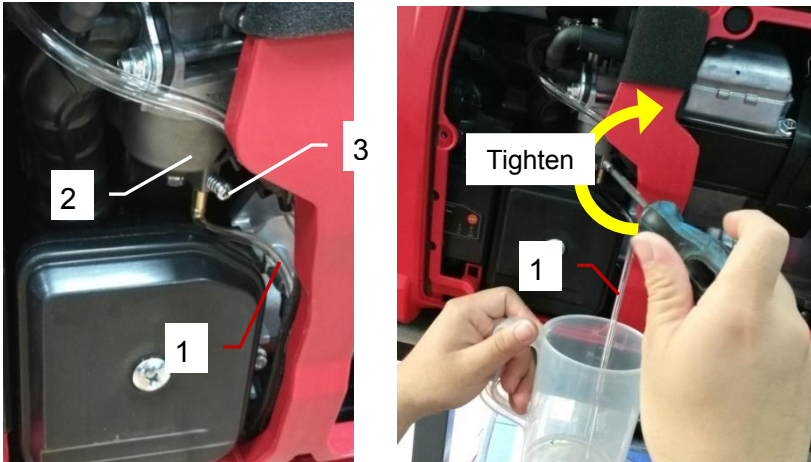

- (1). Turn the Fuel Cap Vent Lever to “ON” position.
- (2). Turn the Fuel Tap to the “ON” position.
- (3). Put the Drain Hose 1 into a suitable container.
- (4). Loosen the Drain Screw 3 counterclockwise.
- (5). Drain the gasoline from the Carburetor 2 into the container through the Drain Hose 1.
- (6). Tighten the Drain Screw 3 clockwise securely.
- (7). Reinstall the Drain Hose 1 into the hole at the bottom casing.
- (8). Reinstall the Maintenance Cover 4.
- (9). Turn the Fuel Tap to the “OFF” position.
- (10). Turn the Fuel Cap Vent Lever to “OFF” position.

⚠ WARNING

- **Gasoline is highly flammable and explosive.**
- **Keep heat, sparks, and flame away.**
- **Handle fuel only outdoors.**
- **Wipe up spills immediately.**

11.4 ENGINE

- (1). While engine is still warm, drain oil from crankcase. Refill with the recommended new oil.
- (2). Remove spark plug and pour about 15ml (1/2 ounce) of engine oil into the cylinder through spark plug hole on the engine cylinder head, and cover spark plug hole with rag. Pull the starting rope several times to coat the cylinder walls with engine oil.
- (3). Install and tighten the spark plug.
- (4). Pull the Starter Grip until you feel compression, and then stop pulling. (This prevents the cylinder and valves from rusting)
- (5). Clean the generator outer surfaces. Check that cooling air slots and openings on generator are open and unobstructed.
- (6). Store the unit in a clean, dry place. If possible, store the unit indoors and cover it to give protection from dust and dirt.

12. TROUBLE SHOOTING

When the engine cannot be started:

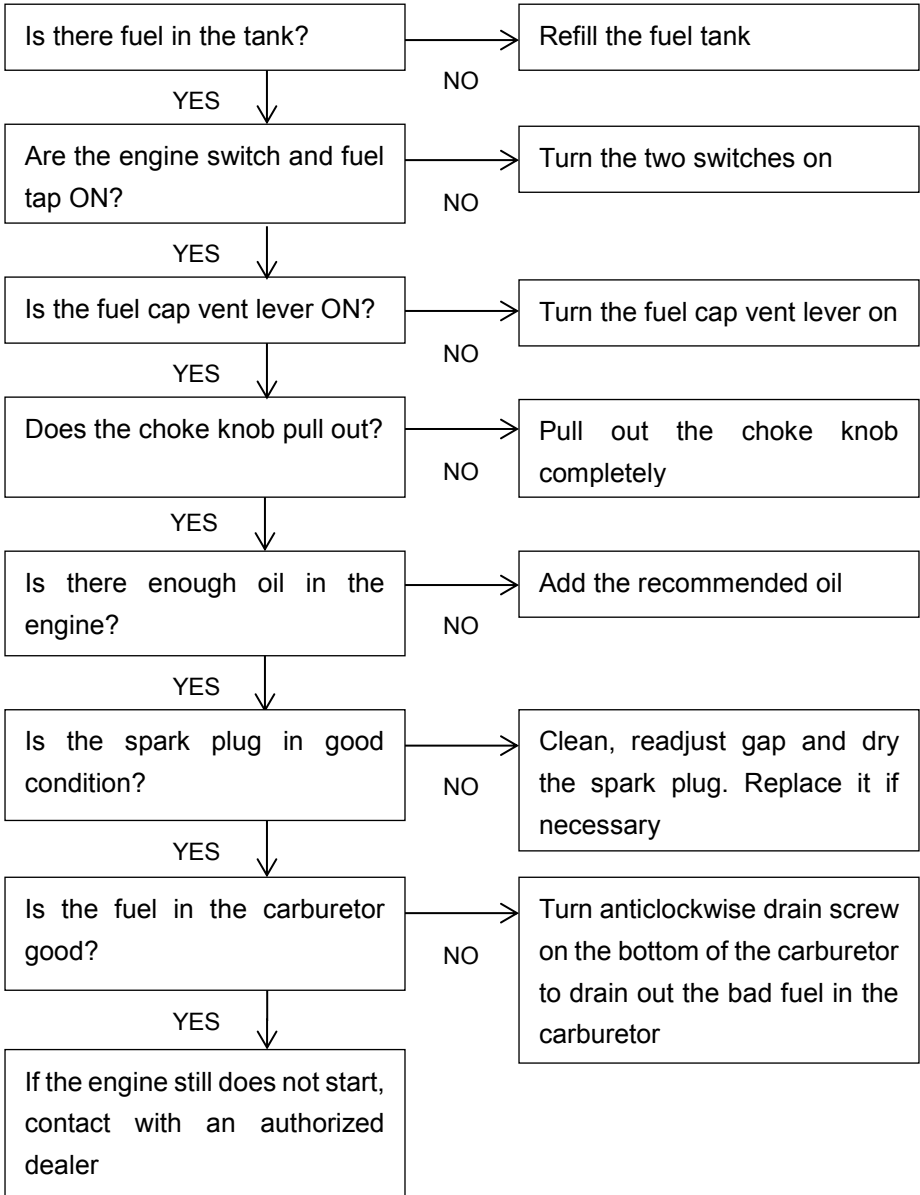

Engine starts, and then shuts down:

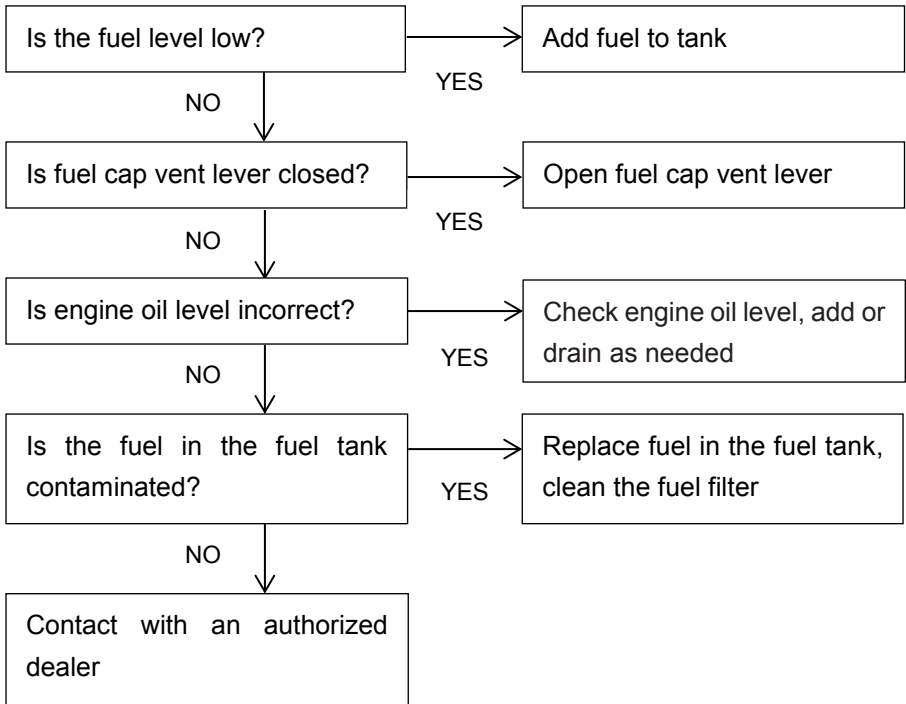

Engine starts, then runs rough:

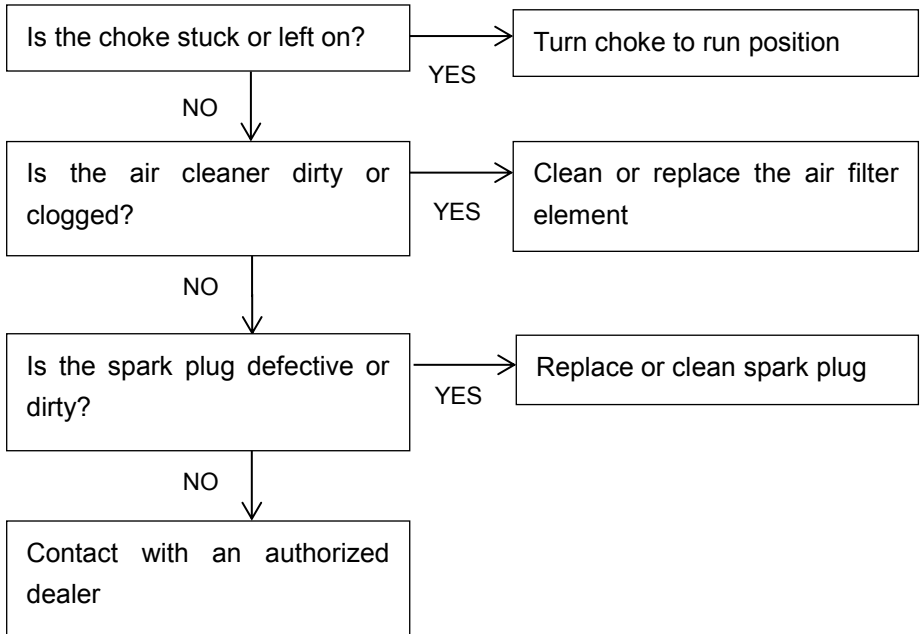

No AC output:

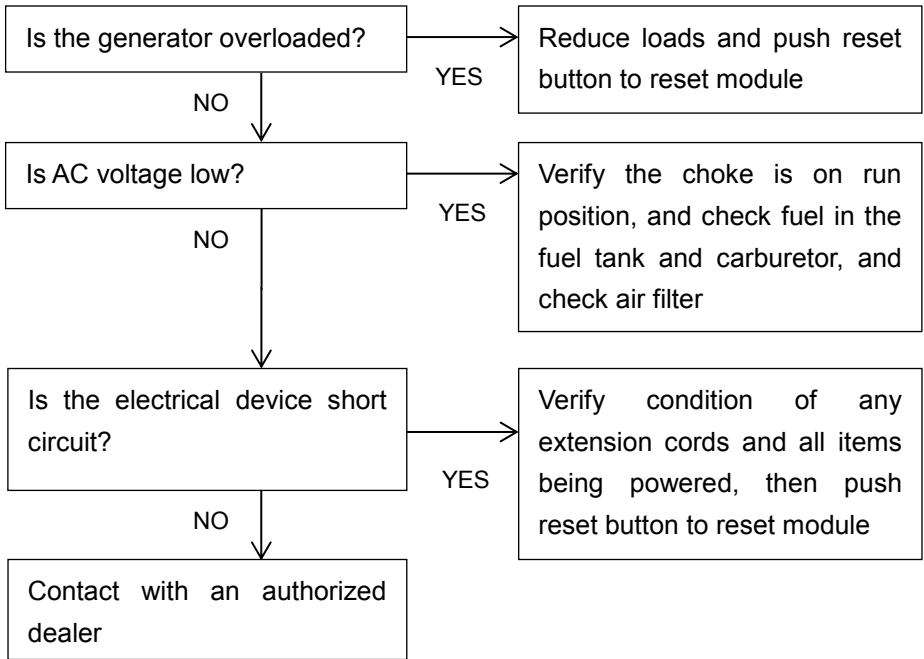

No DC output

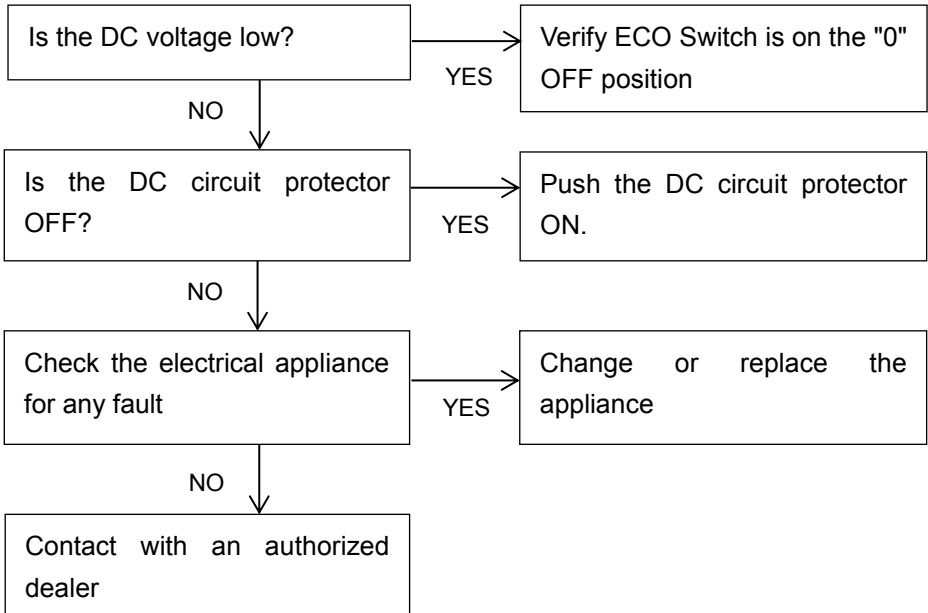

Fuel leaks from drain hoses.

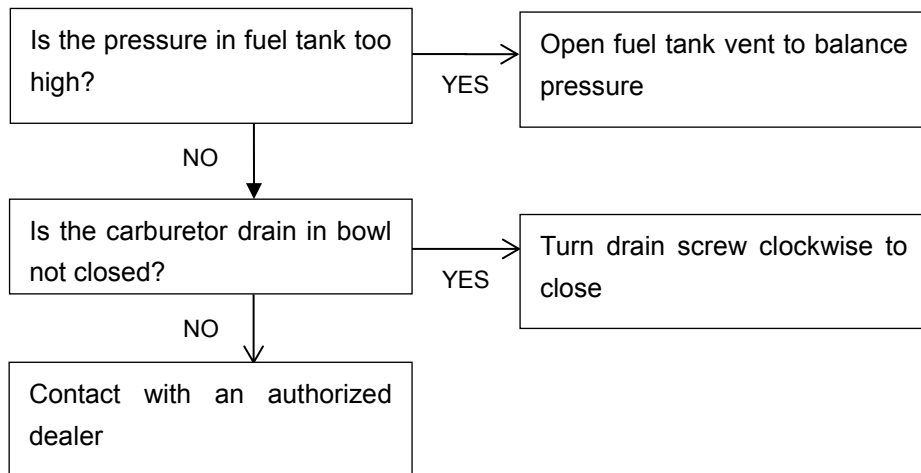

13. SPECIFICATIONS

DIMENSIONS AND WEIGHT

Overall Length	530mm (20.9 in)
Overall Width	320mm (12.6 in)
Overall Height	430mm (16.9 in)
Dry Weight	24kg (52.9 lbs.)

ENGINE

Type	4-stroke gasoline OHV
Cooling System	Forced air
Cylinder Arrangement	Inclined, single cylinder
Displacement	98cm ³
Bore × Stroke	52.0mm×46.0mm (2.05 in×1.81 in)
Engine Speed	3000~5000rpm (with ECO ON)
Operation Hours	3.75Hr@rated load

Fuel		Unleaded gasoline
Fuel Tank Capacity		4.2L (1.11 US gal)
Engine Oil Capacity		0.4L (0.42 US qt)
Ignition System		CDI
Spark Plug	Type	E6RTC
	Gap	0.7~0.8mm (0.027~0.031in)
Noise Level		Measured LpA: 70,46dB(A), K=3,0dB(A) LwA: 91,46 dB, K = 0,75 dB(A) Guarantee sound power level LwA: 92 dB(A)

GENERATOR

AC Output	Rated Voltage	230V
	Rated Frequency	50Hz
	Rated Current	7.8A
	Rated Output	1.8kW
	Maximum Output	2.1kW
	Safety Device Type	Electronic
DC Output	Rated Voltage	12V
	Rated Current	8,0A
	USB	5V, 2A/1A
	Safety Device Type	DC Protector

NOTE

The generator output specifications are based on the standard environment as follows:

- **Altitude: 0m**
- **Ambient temperature: 25°C**
- **Relative humidity: 30%**

14. WIRING DIAGRAM

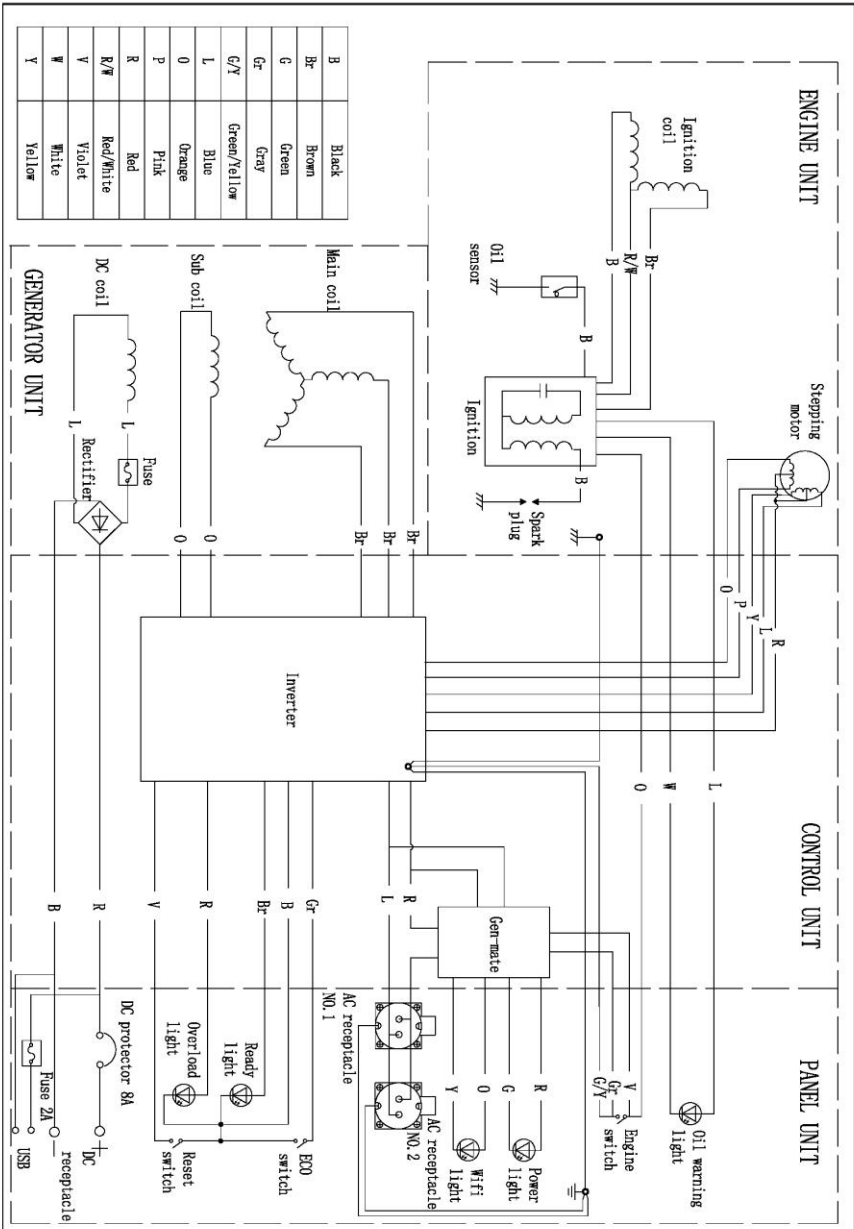

15. ENVIRONMENT CORRECTION

The rated power output is based on the standard condition as follows:

- Altitude: 0m
- Ambient temperature: 25°C
- Relative humidity: 30%

Factor of environment correction C:

Altitude(m)	Ambient temperature°C				
	25	30	35	40	45
0	1	0.98	0.96	0.93	0.90
500	0.93	0.91	0.89	0.87	0.84
1000	0.87	0.85	0.82	0.80	0.78
2000	0.75	0.73	0.71	0.69	0.66
3000	0.64	0.62	0.60	0.58	0.56
4000	0.52	0.52	0.50	0.48	0.46

NOTE:

Relative humidity 60% correction factor C-0.01;

Relative humidity 80% correction factor C-0.02;

Relative humidity 90% correction factor C-0.03;

Relative humidity 100% correction factor C-0.04;

Example: Generator rated power $P_N = 1.8\text{kVA}$, Altitude: 1000m,

Ambient temperature: 35°C, Relative humidity: 80%,

Actual power P:

$$P = P_N * (C - 0.02) = 1.8 * (0.82 - 0.02) = 1.44\text{kVA}$$



WARRANTY

The manufacturer warrants the product against defects in materials and workmanship for a period of 2 years from the date of purchase to the original purchaser. The guarantee applies when the product is used as a home tool. The warranty does not extend for failures due to normal wear and tear.

The manufacturer agrees to replace the spare parts that are classified as defective by a designated distributor. The manufacturer will not accept responsibility for the replacement of the machine, either partially or in full, and / or consequential damages.

The warranty does not cover failures due to:

- Insufficient maintenance.
- Assembly, adjustment or abnormal operation of the product.
- Spare parts that are subject to wear.

Nor does the guarantee extend to:

- Cost of freight and packaging.
- The use of the tool for any other purpose than for which it was designed
- Use and maintenance of the machine in a manner not described in the user's manual.

As part of our policy of continuous product improvement, we reserve the right to alter or modify specifications without prior notice.

As a result, the product may differ from the information contained herein, but any alteration will only be implemented without prior notice if it is classified as an improvement of the previous specification.

READ THE MANUAL CAREFULLY BEFORE USING THE MACHINE.

When ordering spare parts, please quote the part number or code, this can be found in the parts list included in this manual.

Keep the purchase receipt; Without it, no guarantee will be valid.

In order to get help about your Generator, we invite you to go through this link or to call us by phone +33 (0) 8 20 20 22 68:

<https://services.swap-europe.com/contact>

You need to create a "ticket" via their platform.

- Login or create your account
- Put your tool reference
- Choose the subject of your request
- Explain your problem
- Attach these files: the invoice or receipt, the nameplate picture (serial number), the picture of the part you need (For example: pins on the transformer plug that broke away)

We offer you a warranty extension to 1 year. To profit it, please follow the below proceeding:

- Connect on the website:
- Insert your contact details
- Register your tool with:
 - The reference
 - The serial number
 - The date you bought the tool
- Generate automatically the PDF warranty certificate and print it.

CE DECLARATION

BUILDER SAS

ZI, 32 RUE ARISTIDE BERGES – 312070 CUGNAUX – FRANCE

Declares that the machinery designated below:

Inverter Generating set

Model: EZG2000iUK

Serial number:

Complies with the provisions of the Directive “machinery” 2006/42/EC and national laws transposing it:

Also complies with the following European directives:

EMC Directive 2014/30/EU

ROHS Directive 2011/65/EU

Directive 97/68/EC and 2012/46/EU

Noise directive 2000/14/EC Annex VI + 2005/88/EC

Also complies with European standards, with national standards:

EN ISO 8528-13:2016 EN 55012:2007/A1:2009 EN 61000-6-1:2007

Notified Body: Intertek Testing & Certification Ltd. (Notified Body 0359)

Davy Avenue, Know hill, Milton Keynes, MK5 8NLT

Measured sound power level, LwA: 91, 46 dB, K = 0, 75 dB (A)

Guaranteed Sound power level: 92 dB (A)

Responsible for the technical file: Michel Krebs

Cugnaux, 01/01/2018



Philippe MARIE / PDG