

EN

Instruction manual

Cordless Drill

CCD20V2A (DY94273)



ORIGINAL INSTRUCTIONS

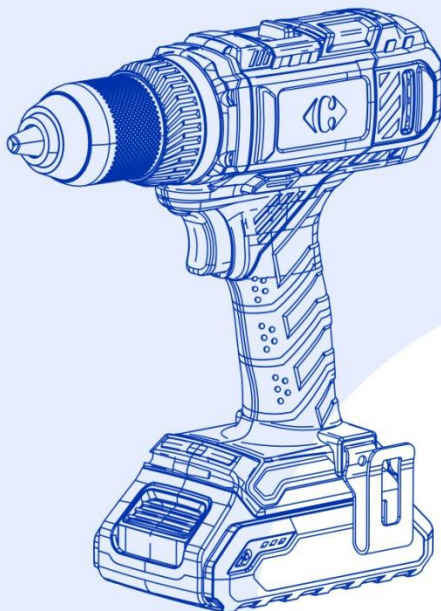

V01_21



Congratulation on your purchase.

The quality team at CARREFOUR cares for its products to meet conformity and performances. Paying close attention to your satisfaction, our experts work all day on the improvement of our products.



For assembly and/or maintenance and/or use of your product, you can use:

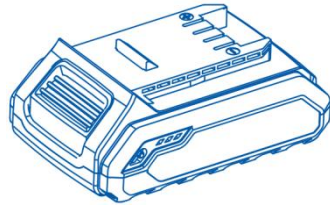
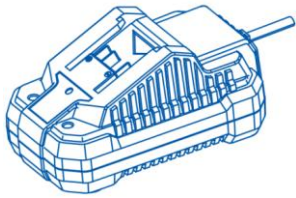

These products are available in CARREFOUR stores.



Read this manual carefully

For a better use of your new device, we recommend you to read carefully this Instruction Manual and keep it for record.

Keep it carefully for future reference.











Please also find information about the scraping of the product in this Instruction Manual.



Safety instructions

Before installing or using this product, please read carefully the safety measures after the table of contents.

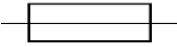
Pictograms used

	Warning symbols with information on damage and injury prevention.
	Read the operation instructions carefully.
	Read and understand all instructions before operating the product. Follow all warnings and safety instructions.
 	Electrical products must not be disposed of with the domestic waste.
	Protect the rechargeable battery from sunlight and heat (max.50°C) .
	Protect the rechargeable battery from water and moisture.
	Protect the rechargeable battery from fire.
	The charger is for indoor use only.
<p data-bbox="145 1308 229 1339">T3.15 A</p> 	Miniature fuse
	Protection class II (double insulation)

CONTENTS

SAFETY INSTRUCTIONS	5
PRODUCT DESCRIPTION.....	10
INTENDED USE.....	13
BEFORE USE.....	13
OPERATION	15
CLEANING & MAINTENANCE	17
STORAGE AND TRANSPORTATION	17
REPLACEMENT PARTS /ACCESSORIES	18
TROUBLESHOOTING	18
DISPOSAL	19
DECLARATION OF CONFORMITY	20
WARRANTY	21
PRODUCT FAILURE.....	22
WARRANTY EXCLUSIONS	23

SAFETY INSTRUCTIONS

GENERAL POWER TOOL SAFETY WARNINGS

WARNING Read all safety warnings, instructions, illustrations and specifications provided with this power tool. *Failure to follow all instructions listed below may result in electric shock, fire and/or serious injury.*

Save all warnings and instructions for future reference.

The term "power tool" in the warnings refers to your mains-operated (corded) power tool or battery-operated(cordless) power tool.

1. Work area safety

a) Keep work area clean and well lit. *Cluttered or dark areas invite accidents.*

b) Do not operate power tools in explosive atmospheres, such as in the presence of flammable liquids, gases or dust. *Power tools create sparks which may ignite the dust or fumes.*

c) Keep children and bystanders away while operating a power tool. *Distractions can cause you to lose control.*

2. Electrical safety

a) Power tool plugs must match the outlet. Never modify the plug in any way. Do not use any adapter plugs with earthed (grounded) power tools. *Unmodified plugs and matching outlets will reduce risk of electric shock.*

b) Avoid body contact with earthed or grounded surfaces, such as pipes, radiators, ranges and refrigerators. *There is an increased risk of electric shock if your body is earthed or grounded.*

c) Do not expose power tools to rain or wet conditions. *Water entering a power tool will increase the risk of electric shock.*

d) Do not abuse the cord. Never use the cord for carrying, pulling or unplugging the power tool. Keep cord away from heat, oil, sharp edges or moving parts. *Damaged or entangled cords increase the risk of electric shock.*

e) When operating a power tool outdoors, use an extension cord suitable for outdoor use. *Use of a cord suitable for outdoor use reduces the risk of electric shock.*

f) If operating a power tool in a damp location is unavoidable, use a residual current device (RCD) protected supply. *Use of an RCD reduces the risk of electric shock.*

3. Personal safety

a) Stay alert, watch what you are doing and use common sense when operating a power tool. Do not use a power tool while you are tired or under the influence of drugs, alcohol or medication. *A moment of inattention while operating power tools may result in serious personal injury.*

b) Use personal protective equipment. Always wear eye protection. *Protective equipment such as a dust mask, non-skid safety shoes, hard hat or hearing protection used for appropriate conditions will reduce personal injuries.*

c) Prevent unintentional starting. Ensure the switch is in the off-position before connecting to power source and/or battery pack, picking up or carrying the tool. *Carrying power tools with your finger on the switch or energising power tools that have the switch on invites accidents.*

d) Remove any adjusting key or wrench before turning the power tool on. *A wrench or a key left attached to a rotating part of the power tool may result in personal injury.*

e) Do not overreach. Keep proper footing and balance at all times. *This enables better control of the power tool in unexpected situations.*

f) Dress properly. Do not wear loose clothing or jewellery. Keep your hair and clothing away from moving parts. *Loose clothes, jewellery or long hair can be caught in moving parts.*

g) If devices are provided for the connection of dust extraction and collection facilities, ensure these are connected and properly used. *Use of dust collection can reduce dust-related hazards.*

h) Do not let familiarity gained from frequent use of tools allow you to become complacent and ignore tool safety principles. *A careless action can cause severe injury within a fraction of a second.*

4. Power tool use and care

a) Do not force the power tool. Use the correct power tool for your application. *The correct power tool will do the job better and safer at the rate for which it was designed.*

b) Do not use the power tool if the switch does not turn it on and off. *Any power tool that cannot be controlled with the switch is dangerous and must be repaired.*

c) Disconnect the plug from the power source and/or remove the battery pack, if detachable, from the power tool before making any adjustments, changing accessories, or storing power tools. *Such preventive safety measures reduce the risk of starting the power tool accidentally.*

d) Store idle power tools out of the reach of children and do not allow persons unfamiliar with the power tool or these instructions to operate the power tool. *Power tools are dangerous in the hands of untrained users.*

e) Maintain power tools and accessories. Check for misalignment or binding of moving parts, breakage of parts and any other condition that may affect the power tool's operation. If damaged, have the power tool repaired before use. *Many accidents are caused by poorly maintained power tools.*

f) Keep cutting tools sharp and clean. *Properly maintained cutting tools with sharp cutting edges are less likely to bind and are easier to control.*

g) Use the power tool, accessories and tool bits etc. in accordance with these instructions, taking into account the working conditions and the work to be performed. *Use of the power tool for operations different from those intended could result in a hazardous situation.*

h) Keep handles and grasping surfaces dry, clean and free from oil and grease. *Slippery handles and grasping surfaces do not allow for safe handling and control of the tool in unexpected situations.*

5. Battery tool use and care

a) Recharge only with the charger specified by the manufacturer. *A charger that is suitable for one type of battery pack may create a risk of fire when used with another battery pack.*

b) Use power tools only with specifically designated battery packs. *Use of any other battery packs may create a risk of injury and fire.*

c) When battery pack is not in use, keep it away from other metal objects, like paper clips, coins, keys, nails, screws or other small metal objects, that can make a connection from one terminal to another. *Shorting the battery terminals together may cause burns or a fire.*

d) Under abusive conditions, liquid may be ejected from the battery; avoid contact. If contact accidentally occurs, flush with water. If liquid contacts eyes, additionally seek medical help. *Liquid ejected from the battery may cause irritation or burns.*

e) Do not use a battery pack or tool that is damaged or modified. *Damaged or modified batteries may exhibit unpredictable behaviour resulting in fire, explosion or risk of injury.*

f) Do not expose a battery pack or tool to fire or excessive temperature. *Exposure to fire or temperature above 130 °C may cause explosion.*

g) Follow all charging instructions and do not charge the battery pack or tool outside the temperature range specified in the instructions. *Charging improperly or at temperatures outside the specified range may damage the battery and increase the risk of fire.*

6. Service

a) Have your power tool serviced by a qualified repair person using only identical replacement parts. *This will ensure that the safety of the power tool is maintained.*

b) Never service damaged battery packs. *Service of battery packs should only be performed by the manufacturer or authorized service providers.*

DRILL SAFETY WARNINGS

- 1. Wear ear protectors when impact drilling.** *Exposure to noise can cause hearing loss.*
- 2. Use auxiliary handle(s), if supplied with the tool.** *Loss of control can cause personal injury.*
- 3. Brace the tool properly before use.** *This tool produces a high output torque and without properly bracing the tool during operation, loss of control may occur resulting in personal injury.*
- 4. Hold power tool by insulated gripping surfaces, when performing an operation where the cutting accessory may contact hidden wiring.** *Cutting accessory contacting a "live" wire may make exposed metal parts of the power tool "live" and could give the operator an electric shock.*

SAFETY INSTRUCTIONS WHEN USING LONG DRILL BITS

- 1. Never operate at higher speed than the maximum speed rating of the drill bit.** *At higher speeds, the bit is likely to bend if allowed to rotate freely without contacting the workpiece, resulting in personal injury.*
- 2. Always start drilling at low speed and with the bit tip in contact with the workpiece.** *At higher speeds, the bit is likely to bend if allowed to rotate freely without contacting the workpiece, resulting in personal injury.*
- 3. Apply pressure only in direct line with the bit and do not apply excessive pressure.** *Bits can bend causing breakage or loss of control, resulting in personal injury.*

ADDITIONAL INSTRUCTIONS

1. Keep all safety devices, air vents and the motor housing free of dirt and dust as far as possible. Wipe the equipment with a clean cloth or blow it with compressed air at low pressure
2. We recommend that you clean the device immediately each time you have finished using it
3. Clean the equipment regularly with a moist cloth and some soft soap. Do not use cleaning agents or solvents; these could attack the plastic parts of the equipment. Ensure that no water can seep into the device. The ingress of water into an electric tool increases the risk of an electric shock.
4. The electrical current used must correspond to the specifications of the battery charger; read carefully the instructions and technical specifications of the charger and the battery.
5. Never allow moisture, rain or splash to reach the recharging location.
6. The ambient temperature should never exceed 50°C. Never expose the unit to direct sunlight.
7. A faulty or damaged battery pack or no longer accepting a load must be disposed of at a special collection point. Respect the environment. Do not dispose of an unusable battery pack with household waste in the fire or in water.
8. Always keep the surface of the charger free of dust and dirt.
9. Always remove the battery pack before performing any operation or maintenance on the device.
10. Use a dust collector to collect the dust when the will produce a considerable amount of dust. Follow the instruction manual of the collector dust to know how to install and how to use it.

RESIDUAL RISKS

Even with use of the tool as described, it is impossible to eliminate all residual risk factors. The following hazards may be present in connection with the construction and design of the tool:

1. Pulmonary lesions if an effective mask is not worn.

2. Hearing damage if effective hearing protection is not worn.
3. Body injuries caused by vibration emissions if the electrical appliance is used improperly or for a prolonged or poorly maintained period.

WARNING! This device produces an electromagnetic field during operation. This field may interfere in certain circumstances with active or passive medical implants. To reduce the risk of serious or fatal injury, we recommend that people with medical implants consult with their physician and the medical implant manufacturer before using this device.

SPECIAL SAFETY INSTRUCTIONS FOR BATTERY-OPERATED TOOLS

1. **Ensure that the tool is switched off before inserting the battery.** Inserting a battery into a tool that is switched on may result in accidents.
2. **Recharge the batteries indoors only because the battery charger is designed for indoor use only.** Risk of electric shock.
3. **To reduce the electric shock hazard, unplug the battery charger from the mains before cleaning the charger.**
4. **Do not subject the battery to strong sunlight over long periods and do not leave it on a heater.** Heat damages the battery and this is risk of explosion.
5. **Allow a hot battery to cool before charging.**
6. **Do not open up the battery and avoid mechanical damage to the battery. Risk of short circuit and fumes may be emitted that irritate the respiratory tract.** Ensure fresh air and seek medical assistance in the event of discomfort.
7. **Do not use non-rechargeable battery.** This could damage the appliance.
8. **The recommended ambient temperature range for the charging system during charging is from 4°C to 40 °C.**
9. **The recommended ambient temperature range for tool and battery storage is from 0°C to 50 °C.**
10. **The recommended ambient temperature range for tool and battery use is from -5°C to 50 °C.**
11. **Remove the battery from the device before storage.**
12. **Electrolyte leaking from the cells can cause damage to the skin, clothes or any other items exposed to it. If the electrolyte contacts the skin or clothes, wash thoroughly with clean water. If the electrolyte enters into the eyes, do not rub the eyes but flush them immediately with copious amounts of clean water such as tap water, and immediately consult a doctor.**
13. **Do not disassemble or modify the battery, which can cause short-circuiting between cells or between the cell and its wiring, and disables the battery's safety protection system. These can lead to electrolyte leakage, overheating or a cell or battery, bursting and fire.**
14. **Avoid casual or inadvertent shorting of a battery with metallic objects such as: wire, tools, neckless or hairpins, which can cause short-circuiting, which cause excess current flow, electrolyte leakage, heating of cells or batteries, bursting and fire.**
15. **Keep battery away from a fire or heat. The insulation materials will melt and the gas release vent and protection system will be damaged, causing electrolyte leakage, bursting and possibly fire.**
16. **Not allow the battery to contact with water or gets wet, it may short-circuit, overheat, rust or lose its functions.**
17. **Do not expose the battery to mechanical shock, for example, by dropping, throwing or crushing,**

causing electrolyte leakage, cell and battery heating, bursting and fire.

18. Avoid the battery to directly connect to electric source such as a car lighter socket, or car battery, which may cause excess current to flow at high voltage and can cause electrolyte leakage, overheating of a cell or battery, bursting and fire.

SAFETY INSTRUCTIONS FOR CHARGER

1. This charger can be used by children aged from 8 years and above and persons with reduced physical, sensory or mental capabilities or lack of experience and knowledge if they have been given supervision or instruction concerning use of the charger in the safe way and understand the hazards involved. Children shall not play with the charger. Cleaning and user maintenance of the charger shall not be made by children without adult supervision.
2. If the supply cord is damaged, it must be replaced by the manufacturer, its service agent or similarly qualified persons in order to avoid a hazard.
3. Only use this charger CCH20V to charge the battery pack CBA20V2A.
4. To charge the battery, use only the charger supplied
5. Never charge non-rechargeable batteries.
6. During charging the batteries must be placed in a well ventilated area.

PRODUCT DESCRIPTION

(Fig. A)

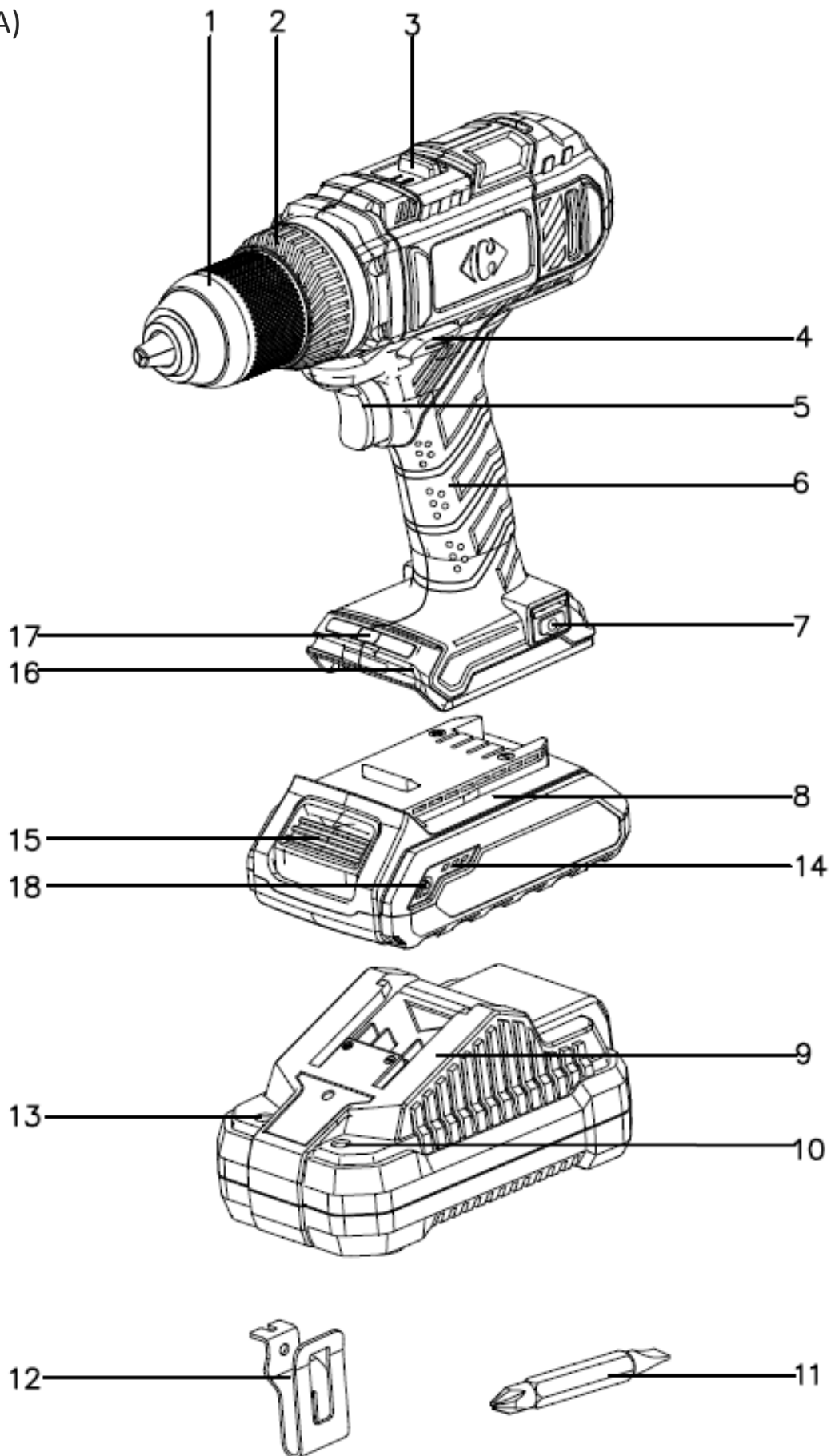

(Fig. B)

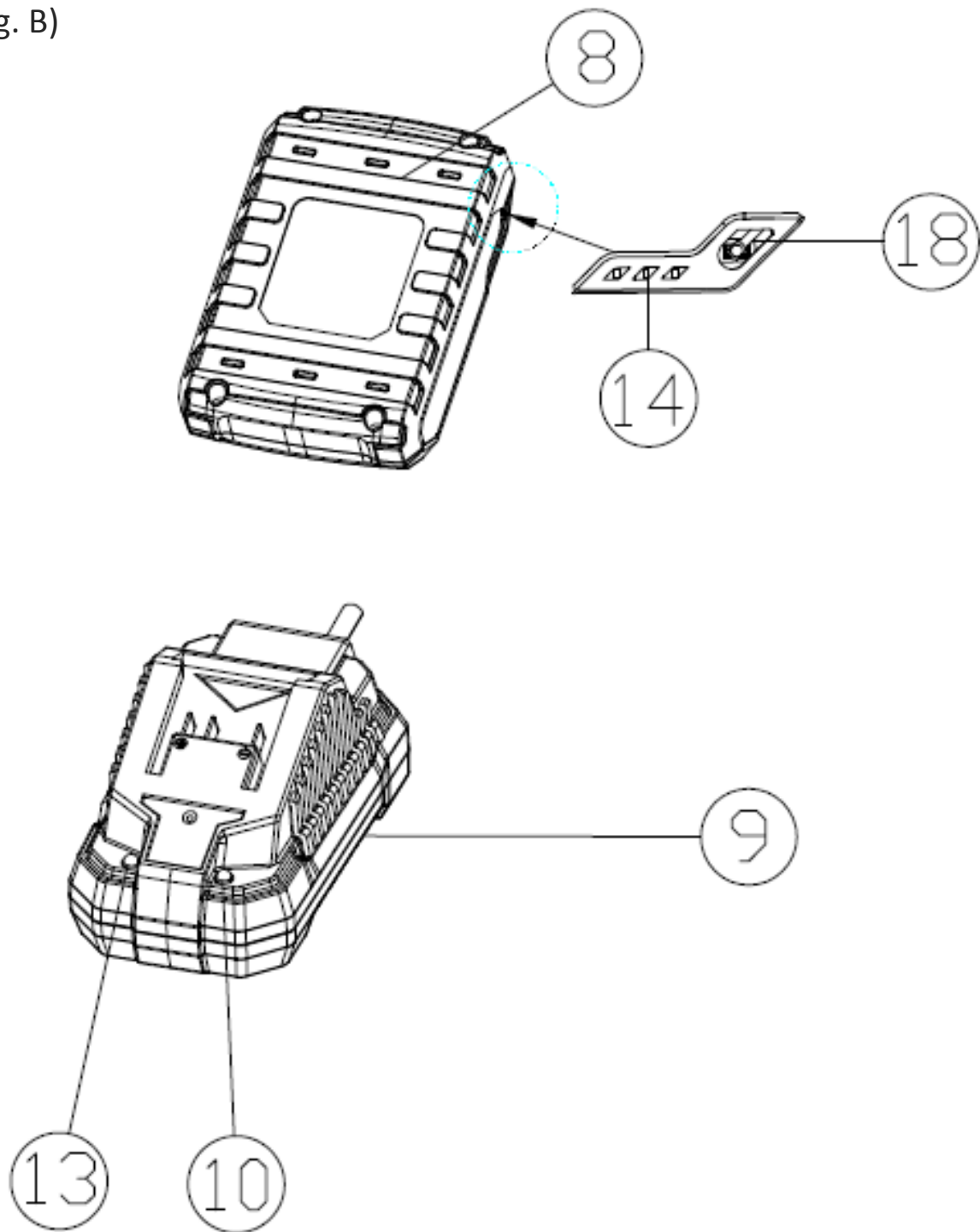

OVERVIEW (Fig. A)

- | | |
|--|------------------------------------|
| 1. Keyless drill chuck | 9. Battery charger |
| 2. Torque selection | 10. RED Charge control LED |
| 3. Gear selection (2 speed levels) | 11. Bits |
| 4. Switch for clockwise / counter-clockwise rotation, lock | 12. Belt clip |
| 5. On/off switch | 13. GREEN charge control LED |
| 6. Handle | 14. Battery level indication (LED) |
| 7. Attachment for belt clip | 15. Battery release buttons |
| 8. Battery pack | 16. Battery holder |
| 18. Battery charge level button | 17. LED work lamp |

DEVICE DESCRIPTION

The cordless drill has two speed levels: while the first speed level is suitable for screwing, drilling can be performed using the second speed level.

The integrated torque selection, including one drilling setting, allows you to use the optimum power for every application, adapted to the material and screw size.

The keyless drill chuck with automatic spindle lock further enables an easy and tool-free exchange of the insertion tools.

The integrated LED work lamp offers an improved illumination of the workpiece or working surface, and the optionally mountable belt clip facilitates transport and provides faster access to the device.

The battery comes with its own battery level indication. As a result, you can check the current charging status without having to connect it to the device.

TECHNICAL DATA

Rated voltage	20V d.c.
Rated no-load speed n_0	0-400/min, 0-1400/min
Torque setting	25+1
Chuck Range	Max. 13mm
Max. drilling Diameter	Wood 30mm Metal 13mm
Max. torque	45Nm
Weight (without charger)	1.66kg
Battery pack	CBA20V2A
Type	Li-ion
Rated voltage	20V d.c.
Capacity	2.0Ah (40Wh)
Battery charger	CCH20V
Rated input	230-240V, 50Hz
Rated input Power	65W
Rated output	21.5V d.c.
Charging current	2.4A
Charging time	Approx. 60min
Protection class	II
Noise emission value	
Noise measurement value determined in accordance with EN 62841-2-1	
L_{PA}	67.23dB(A)
Uncertainty K	5dB
L_{WA}	78.23dB(A)
Uncertainty K	5dB
Vibration emission value	
Vibration value determined in accordance with EN 62841-2-1	
$a_{h,D}$	2.6 m/s ²
Uncertainty K	1.5 m/s ²

- The declared vibration total values and the declared noise emission values have been measured in

accordance with a standard test method and may be used for comparing one tool with another.

- The declared vibration total values and the declared noise emission values may also be used in a preliminary assessment of exposure.

WARNINGS

- The vibration and noise emissions during actual use of the power tool can differ from the declared values depending on the ways in which the tool is used especially what kind of workpiece is processed;
- It is necessary to identify safety measures to protect the operator that are based on an estimation of exposure in the actual conditions of use (taking account of all parts of the operating cycle such as the times when the tool is switched off and when it is running idle in addition to the trigger time)

INTENDED USE

The product is designed for

1. Screwing in and loosening screws
2. Drilling in wood, plastic, ceramic and metal.

Any other uses or modification to the product are deemed to be improper usage and may result in serious physical injury. The manufacturer accepts no responsibility for damage(s) attributable to misuse. This product is designed for use by adults and not intended for commercial use.

BEFORE USE

UNPACKING

1. Unpack all parts and lay them on a flat stable surface
2. Make sure the delivery contents are complete and free of damage. If you find that parts are missing or show damage, do not use the product but contact your dealer/service center. Do not use the product unless missing parts have been delivered in addition or defective parts have been replaced. Using an incomplete or damaged product represents a hazard to people and property.
3. Ensure that you have all the accessories and tools needed for assembly and operation.

SCOPE OF THE DELIVERY

Carefully unpack the cordless drill and check that it is complete:

- 1x Battery-operated cordless drill
- 1x battery pack 2.0Ah
- 1x battery charger
- 1 x SL/PH drill bit
- 1 x belt clip
- 1 x transport case
- 1x Instruction manual

CHARGING THE BATTERY PACK (FIG. B)

Note:

1. **The battery can be damaged in case of improper charging.**
2. **Remove the charger's mains plug before inserting or removing the battery.**

The battery is partially charged upon delivery to avoid damage to the battery caused by a deep discharge. Prior to initial start-up and when the battery is low, the battery should be charged. To do so, please proceed as follows (Fig. B):

1. Slide the battery pack (8) onto the charger (9) upside down till it locks in place.
2. Insert the mains plug of the charger (9) into a properly fused mains socket. The RED charge control LED (10) is illuminated; and charging requires approx. 60min.
3. Wait until the RED charge control LED (10) goes out and green charge control LED (13) is illuminated, the battery is fully charged.
4. Hold onto the mains plug while pulling the power cable of the charger out of the mains socket. The battery pack (8) and the charger (9) may have become warm during charging, allow the battery to cool down to room temperature.
5. Take the battery (8) out of the charger (9) by pressing and holding the battery release button (15) and pulling the battery pack (8) out of the charger (9).

REMOVING /INSERTING THE BATTERY

1. Set the switch for clockwise/counter-clockwise rotation (4) to center position (lock).
2. Insert the battery pack (8), place it on a guide track and push it back into the battery holder (16). It will audibly snap in.
3. Detach the battery pack (8) from the tool, press the battery release button (15) on the battery pack (8) and pull the battery out.

CHECKING THE BATTERY CHARGING LEVEL

The battery comes with an integrated battery level indication.

The battery status is displayed as follows by the three LEDs of the battery level indication (LED) (14).

LED color	Meaning
Green-Orange-Red	Maximum charge/power
Orange-Red	Medium charge / power
Red	Weak charge – Recharge the battery

Press on the battery charge level button (18) on the battery pack (8). You can read the battery status from the battery level indication (LED) (14).

TOOL CHANGE

The device is equipped with a fully automatic spindle lock. When the tool is at a standstill, the motor drive train is locked so that the keyless drill chuck can be opened. Please proceed as follows to remove or insert tools:

1. Set the switch for clockwise/counter-clockwise rotation (4) to center position (lock).
2. Turn the keyless drill chuck (1) counter-clockwise to open it.
3. If necessary, take the drill bit out of the drill chuck.
4. Insert the appropriate (drill) bit into the drill chuck (1).

5. Tighten the keyless drill chuck (1) by turning clockwise.

TORQUE SELECTION /DRILLING SETTING

Using the torque selection (2), you can choose the desired, optimal torque setting.

1. Select a low torque for smooth-running screws or soft materials.
2. Select a high torque for tight screws and hard materials as well as unscrewing.
3. For drilling, select the drilling setting indicated by the symbol .

Note: Do not use the drilling setting for screwing

TWO-SPEED LEVEL

Note: Only use the gear selection when the device is at a standstill! Otherwise the device might be damaged.

1. Slide the gear selection (3) to the desired position.
2. Speed level 1: speed of up to 400/min, suitable for all screwing applications.
3. Speed level 2: speed of up to 1400/min, suitable for drilling.

MOUNTING THE BELT CLIP

Optionally you can mount the belt clip included in the scope of delivery to the device.

1. Set the switch for clockwise/counter-clockwise rotation (4) to center position (lock).
2. Loosen the screw at the attachment (7) for the belt clip.
3. Fasten the belt clip (12) to the belt clip attachment (7) by means of the screw.

OPERATION

Tips and notes on handling the cordless drill

GENERAL INFORMATION

1. Check the tool in the keyless drill chuck for correct fit before every application. It must be firmly locked and centered in the drill chuck.
2. Screw bits are marked with their size and shape. If you are unsure, check whether the bit can be firmly tightened in the keyless drill chuck without clearance.
3. The center position of the switch for clockwise/counter-clockwise rotation (lock) is suited for work breaks or (drill) bit exchange.

SCREWING

1. In case of soft wood, screws can be screwed in without pre-drilling.
2. In case of hard wood or large screws, it is recommended to use a drill for pre-drilling.

3. When using countersunk screws, the drill hole should be countersunk beforehand.
4. Especially smaller screws and bits may be damaged when selecting an excessive torque and /or speed at the tool.

DRILLING IN GENERAL

1. Take short breaks regularly during drilling, when doing so, take the drill bit out of the drill hole so that the drill bit can cool down.
2. Secure the workpiece in a tensioning device or vice.
3. Select the speed depending on the material characteristics and the size of the drill bit:
4. High speed for small drilling diameter or soft material
5. Low speed for large drilling diameter or hard material
6. Use a suitable aid to mark the intended location of the drill hole.
7. Select a low speed for spudding.

DRILLING IN METAL

1. Use suitable metal drill bits (e.g. drill bits made of high-speed steel (HSS))
2. For large drilling diameter, use a smaller drill bit for pre-drilling.
3. To achieve ideal results, the drill bit should be cooled with a suitable lubricant.
4. Metal drill bits may also be used for drilling in plastic.

DRILLING IN WOOD

1. Use drill bits suitable for wood.
2. Place a block of wood under the workpiece or drill in from both sides so that the wood cannot break off when it is being drilled through.
3. Use a wood drill bit with centering tip. For deep drill holes, use an auger bit; for large drilling diameters, use a Forstner bit.

SELECTING THE ROTATIONAL DIRECTION

Note: Only change the rotational direction when the device is at a standstill! Otherwise the device might be damaged.

Motor rotation direction can be changed by means of the switch for clockwise/counter-clockwise rotation (4).

1. Press switch for clockwise /counter-clockwise rotation (4) in all the way on that side towards which the motor shall rotate
 - I. Screwing in
 - II. Unscrewing
2. Carry out a short test run to see whether the rotational direction matches the intended application. A wrong rotational direction may damage the tool and /or workpiece.
3. If required, set the switch for clockwise/counter-clockwise rotation (4) to center position (lock) to block the on/off switch (5).

SWITCHING ON AND OFF

The device has an infinitely variable speed control. The more firmly you push the on/off switch (5), the

higher the speed is.

1. Check whether the tool clamped in and the torque setting selected are suitable for the intended application.
2. Check whether the workpiece is secured and the worktop prepared correspondingly.
3. Press and hold the on/off switch (5) during screwing or drilling.
4. The LED work lamp (17) is illuminated.
5. Release the on/off switch (5) to stop the device.

CLEANING & MAINTENANCE



WARNING! Risk of injury. Always switch the device off and remove the battery before carrying out any work on the device.

1. The device should be cleaned before and after each use.
2. The device does not have to be lubricated after cleaning.
3. Clean the device with a soft, damp and lint-free cloth. Ensure that no moisture enters the housing. Protect electrical components from moisture. Do not use any aggressive cleaning agent such as cleaning sprays, solvents, alcohol-based or abrasive cleaners to dampen the cloth.
4. Dry the device with a soft, lint-free cloth.
5. Dry the bits with a soft- lint-free cloth.
6. Remove any drilling dust and if applicable, wood chips from the keyless drill chuck.
7. Keep the connection terminals on the device and charger clean.
8. Keep the ventilation openings free from dust deposits to prevent overheating of the motor.

STORAGE AND TRANSPORTATION

STORAGE

Before storing the device, observe the following:

1. Switch off the device by setting the switch for clockwise /counter-clockwise rotation to center position (lock)
2. Hold onto the mains plug while pulling the power cable of the charger out the mains socket.
3. Allow the device to cool down.
4. Remove the battery from the device.
5. Remove the tool from the tool holder.
6. Clean the devices as described in the maintenance part.
7. For storing the device, use the transport case included in the scope of the delivery in order to protect the device from external influences.
8. Do not store Li-ion battery which are completely discharged. Storing discharged battery can lead to a deep discharge and thus damage the battery.

TRANSPORT

For transport the device, use the transport case included in the scope of the delivery in order to protect the device from external influences.

1. Switch off the device by setting the switch for clockwise /counter-clockwise rotation to center position (lock).

2. Hold onto the mains plug while pulling the power cable of the charger out the mains socket.
3. Allow the device to cool down.
4. Remove the battery form the device.
5. Remove the tool from the tool holder
6. Protect the product from any heavy impact or strong vibrations which may occur during transportation in vehicles

REPLACEMENT PARTS /ACCESSORIES

AVAILABLE ACCESSORIES



WARNING! Only use accessories and additional equipment specified in the operating manual. Using insertion tools or accessories other than those specific in the operating manual may cause a risk of injury. Only get the accessories from the Service Centre.

Spare charger & battery pack for 20V platform		
Charging time	Battery Pack CBA20V2A 2Ah	Battery Pack CBA20V4 4Ah
Charger CCH20V	60min	120min
All 20V team shares the compatible charger and battery pack of 20V platform.		

TROUBLESHOOTING



WARNING! Only perform the steps described within these instructions. All further inspection, maintenance and repair work must be performed by an authorized service center or a similarly qualified specialist if you cannot solve the problem yourself. Suspected malfunctions are often due to causes that the users can fix themselves. Therefore check the product using this section. In most cases the problem can be solved quickly

Problem	Possible cause	Corrective action
The tool won't start	Battery discharged	Recharge battery
	Battery not inserted	Insert battery
	On/Off switch defective	Send in to Service Centre for repair
	Battery terminals on dirt	Remove the dirt.
Drill bit does not penetrate or hardly penetrate	Not correct torque setting	Select the correct torque, the drilling setting should be selected.
	Speed setting	Increase the speed to the higher level
	Wrong drill bit	Change to correct drill bit
	Wrong rotation	Check and change to right rotation

the	The materials characteristics is not suitable	Check the materials and make sure the
On/off switch cannot be pressed	The switch for clockwise/ counter-clockwise rotation is in the center position	Check the position of the switch for clockwise/ counter-clockwise rotation, set
	On/off switch defective	Send it to Service Centre for repair

Note: if your device does not operate correctly after these check, please contact the Service Center.

DISPOSAL



To help the environment, please dispose of the product properly when it has reached the end of its useful life and not in the household waste. Information on collection points and their opening hours can be obtained from your local authority



Environmental damage through incorrect disposal of the batteries / rechargeable batteries.

Remove the battery pack from the product before disposal. Batteries /rechargeable batteries may not be disposed of with the usual domestic waste. They may contain toxic heavy metals and are subject to hazardous waste treatment rules and regulations. Please dispose of batteries according to the relevant local requirements.

DECLARATION OF CONFORMITY



Carrefour Marchandises Internationales
93, avenue de Paris
91342 Massy
France

Herewith we declare that the product
Cordless Drill
Model number: CCD20V2A(DY94273)
S/N: 20210706914-20210708917

Is in conformity with the following European Directives
2006/42/EC
2014/30/EU
2014/35/UE
2011/65/EU & (EU) 2015/863

And the harmonized standards
EN 62841-1:2015
EN 62841-2-1:2018+A11:2019
EN 55014-1:2017+A11:2020
EN 55014-2:2015
EN IEC 61000-3-2:2019
EN 61000-3-3:2013+A1:2019
EN 60335-1:2012+A11:2014+A13:2017+A1:2019+A14:2019+A2:2019
EN 60335-2-29: 2004+A2:2010+A11:2018
EN 62233:2008

Manufacturer and name of the authorised representative of the technical documentation

Signature

Place and date:

WARRANTY

The manufacturer guarantees the product against defects in material and workmanship for a period of 2 years from the date of the original purchase. The warranty only applies if the product is for household use. The warranty does not cover breakdowns due to normal wear and tear.

The manufacturer agrees to replace parts identified as defective by the designated distributor. The manufacturer does not accept responsibility for the replacement of the machine, in whole or in part, and/or ensuing damage.

The warranty does not cover breakdowns due to:

- insufficient maintenance.
- abnormal assembly, adjustment or operations of the product.
- parts subject to normal wear and tear.

The warranty does not extend to:

- shipping and packaging costs.
- using the tool for a purpose other than that for which it was designed.
- the use and maintenance of the machine done in a manner not described in the user manual.

Due to our policy of continuous product improvement, we reserve the right to alter or change specifications without notice. Consequently, the product may be different from the information contained therein, but a modification will be undertaken without notice if it is recognized as an improvement of the preceding characteristic.

READ THE MANUAL CAREFULLY BEFORE USING THE MACHINE.

When ordering spare parts, please indicate the part number or code, you can find this in the spare parts list in this manual. Keep the purchase receipt; without it, the warranty is invalid. To help you with your product, we invite you to contact us by phone or via our website:

+33 (0)9.70.75.30.30

<https://services.swap-europe.com/contact>

You must create a "ticket" via the web platform.

Register or create your account.

Indicate the reference of the tool.

Choose the subject of your request.

Describe your problem.

Attach these files: invoice or sales receipt, photo of the identification plate (serial number), photo of the part you need (for example: pins on the transformer plug which are broken).



PRODUCT FAILURE

WHAT TO DO IF MY MACHINE BREAKS DOWN?

If you bought your product in a store:

- Make sure that your machine is complete with all accessories supplied, and clean! If this is not the case, the repairer will refuse the machine.
- Go to the store with the complete machine and with the receipt or invoice.

If you bought your product on a website:

- Make sure that your machine is complete with all accessories supplied, and clean! If this is not the case, the repairer will refuse the machine.
- Create a SWAP-Europe service ticket on the site: <https://services.swap-europe.com> When making the request on SWAP-Europe, you must attach the invoice and the photo of the nameplate (serial number).

Contact the repair station to make sure it is available before dropping off the machine.

Go to the repair station with the complete machine packed, accompanied by the purchase invoice and the station support sheet downloadable after the service request is completed on the SWAP-Europe site

Please keep your original packaging to allow for after-sales service returns or pack your machine with a similar cardboard box of the same dimensions.

For any question concerning our after-sales service you can make a request on our website <https://services.swap-europe.com>

Our hotline remains available at +33 (9) 70 75 30 30.



WARRANTY EXCLUSIONS

THE WARRANTY DOES NOT COVER:

- Start-up and setting up of the product.
- Damage resulting from normal wear and tear of the product.
- Damage resulting from improper use of the product.
- Damage resulting from assembly or start-up not in accordance with the user manual.
- Breakdowns related to carburetion beyond 90 days and fouling of carburetors.
- Periodic and standard maintenance events.
- Actions of modification and dismantling that directly void the warranty.
- Products whose original authentication marking (brand, serial number) has been degraded, altered or withdrawn.
- Replacement of consumables.
- The use of non-original parts.
- Breakage of parts following impacts or projections.
- Accessories breakdowns.
- Defects and their consequences linked to any external cause.
- Loss of components and loss due to insufficient screwing.
- Cutting components and any damage related to the loosening of parts.
- Overload or overheating.
- Poor power supply quality: faulty voltage, voltage error, etc.
- Damages resulting from the deprivation of enjoyment of the product during the time necessary for repairs and more generally the costs related to the immobilization of the product.
- The costs of a second opinion established by a third party following an estimate by a SWAP-Europe repair station
- The use of a product which would show a defect or a breakage which was not the subject of an immediate report and/or repair with the services of SWAP-Europe.
- Deterioration linked to transport and storage*.
- Launchers beyond 90 days.
- Oil, petrol, grease.
- Damages related to the use of non-compliant fuels or lubricants.

* In accordance with transport legislation, damage related to transport must be declared to carriers within 48 hours maximum after observation by registered letter with acknowledgement of receipt.

This document is a supplement to your notice, a non-exhaustive list.

Attention: all orders must be checked in the presence of the delivery person. In case of refusal by the delivery person, it you must simply refuse the delivery and notify your refusal.

Reminder: the reserves do not exclude the notification by registered letter with acknowledgement within 72 hours.

Information:

Thermal devices must be wintered each season (service available on the SWAP-Europe site). Batteries must be charged before being stored.

Staple here your receipt



Product	Ref	EAN
CORDLESS DRILL	DY94273	3616474461888



EN

For any comments or suggestions

Carrefour Consumer service
– CMI
TSA 91431
91343 MASSY Cedex
France
www.carrefour.fr

 **N°Cristal** 09 69 39 70 00

APPEL NON SURTAXE

More information on
www.mycarrefourdocs.com