

HYUNDAI
POWER PRODUCTS

CORDLESS DRILL

HPP18V2B2A

ORIGINAL INSTRUCTIONS

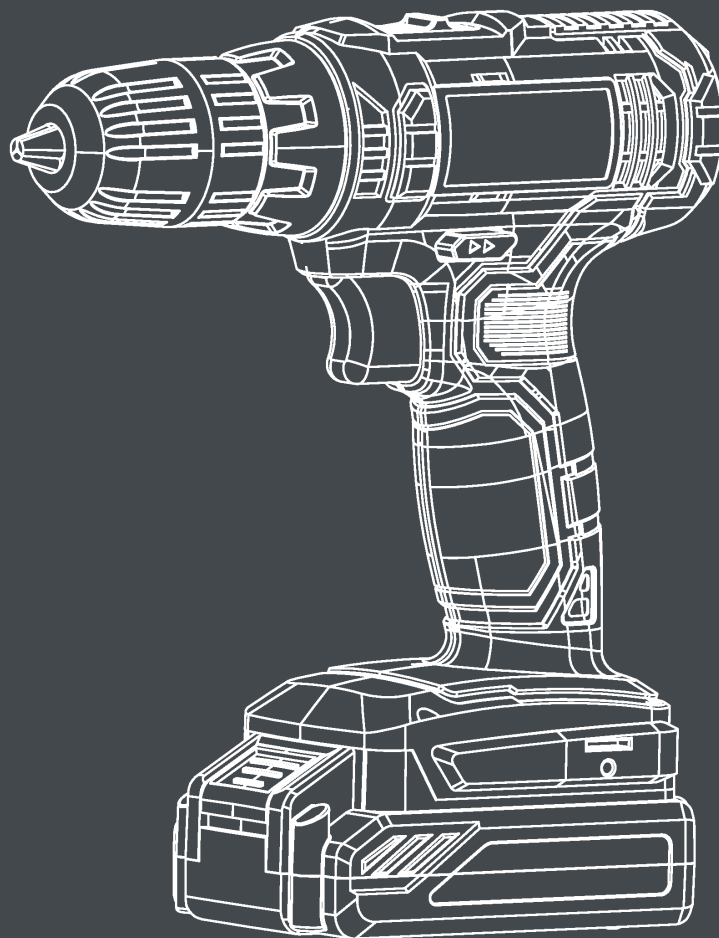

Fig. A



1. APPLICATION

The power tool is intended for driving and drilling through wood and plastics It is not designed for professional use.



WARNING! Read this manual and general safety instructions carefully before using the appliance, for your own safety. Your power tool should only be passed on together with these instructions.

2. DESCRIPTION (FIG A)

- | | |
|-----------------------------|---------------------------|
| 1. On/off switch | 6. Battery release button |
| 2. Forward/reverse switch | 7. LED light |
| 3. Torque adjustment collar | 8. Speed selector |
| 4. Keyless chuck | 9. Loading socket |
| 5. Battery | 10. Charger |

3. PACKAGE CONTENT LIST

- Remove all packaging materials.
- Check that the package contents are complete.
- Check the tool and the charger for transportation damage.
- Keep the packing materials as far as possible till the end of the warranty period. Dispose it into your local waste disposal system afterwards.



WARNING: Packaging materials are not toys! Children must not play with plastic bags! Danger of suffocation!

1 x Cordless drill

1 x Charger

1 x Manual

2 x batteries

Helical HSS drills : (6pcs) 1.5/2.5/3/4/5/6

Bit holder :1pc











Male tips : (6pcs) PH1/9H2/PZ1/PZ2/5/6



If any parts are missing or damaged, please contact your dealer.

4. SYMBOLS

In this manual and/or on the machine the following symbols are used:

	Denotes risk of personal injury or damage to the tool.		In accordance with essential requirements of the European directive(s)
	Wear eye protection		Wear gloves
	Read manual before use		Double insulation (Only for charger)
	Max temperature		Recycle
	Do not put the battery in water		Do not put the battery on fire

5. GENERAL POWER TOOL SAFETY WARNINGS

General power tool safety warnings

WARNING Read all safety warnings, instructions, illustrations and specifications provided with this power tool. *Failure to follow all instructions listed below may result in electric shock, fire and/or serious injury.*

Save all warnings and instructions for future reference.

The term "power tool" in the warnings refers to your mains-operated (corded) power tool or battery-operated (cordless) power tool.

1) Work area safety

a) **Keep work area clean and well lit.** *Cluttered or dark areas invite accidents.*

b) **Do not operate power tools in explosive atmospheres, such as in the presence of flammable liquids, gases or dust.** *Power tools create sparks which may ignite the dust or fumes.*

c) **Keep children and bystanders away while operating a power tool.** *Distractions can cause you to lose control.*

2) Electrical safety

- a) **Power tool plugs must match the outlet. Never modify the plug in any way. Do not use any adapter plugs with earthed (grounded) power tools.** *Unmodified plugs and matching outlets will reduce risk of electric shock.*
- b) **Avoid body contact with earthed or grounded surfaces, such as pipes, radiators, ranges and refrigerators.** *There is an increased risk of electric shock if your body is earthed or grounded.*
- c) **Do not expose power tools to rain or wet conditions.** *Water entering a power tool will increase the risk of electric shock.*
- d) **Do not abuse the cord. Never use the cord for carrying, pulling or unplugging the power tool. Keep cord away from heat, oil, sharp edges or moving parts.** *Damaged or entangled cords increase the risk of electric shock.*
- e) **When operating a power tool outdoors, use an extension cord suitable for outdoor use.** *Use of a cord suitable for outdoor use reduces the risk of electric shock.*
- f) **If operating a power tool in a damp location is unavoidable, use a residual current device (RCD) protected supply.** *Use of an RCD reduces the risk of electric shock.*

3) Personal safety

- a) **Stay alert, watch what you are doing and use common sense when operating a power tool. Do not use a power tool while you are tired or under the influence of drugs, alcohol or medication.** *A moment of inattention while operating power tools may result in serious personal injury.*
- b) **Use personal protective equipment. Always wear eye protection.** *Protective equipment such as a dust mask, non-skid safety shoes, hard hat or hearing protection used for appropriate conditions will reduce personal injuries.*
- c) **Prevent unintentional starting. Ensure the switch is in the off-position before connecting to power source and/or battery pack, picking up or carrying the tool.** *Carrying power tools with your finger on the switch or energising power tools that have the switch on invites accidents.*
- d) **Remove any adjusting key or wrench before turning the power tool on.** *A wrench or a key left attached to a rotating part of the power tool may result in personal injury.*
- e) **Do not overreach. Keep proper footing and balance at all times.** *This enables better control of the power tool in unexpected situations.*
- f) **Dress properly. Do not wear loose clothing or jewellery. Keep your hair and clothing away from moving parts.** *Loose clothes, jewellery or long hair can be caught in moving parts.*
- g) **If devices are provided for the connection of dust extraction and collection facilities, ensure these are connected and properly used.** *Use of dust collection can reduce dust-related hazards.*

h) Do not let familiarity gained from frequent use of tools allow you to become complacent and ignore tool safety principles. *A careless action can cause severe injury within a fraction of a second.*

4) Power tool use and care

a) Do not force the power tool. Use the correct power tool for your application. *The correct power tool will do the job better and safer at the rate for which it was designed.*

b) Do not use the power tool if the switch does not turn it on and off. *Any power tool that cannot be controlled with the switch is dangerous and must be repaired.*

c) Disconnect the plug from the power source and/or remove the battery pack, if detachable, from the power tool before making any adjustments, changing accessories, or storing power tools. *Such preventive safety measures reduce the risk of starting the power tool accidentally.*

d) Store idle power tools out of the reach of children and do not allow persons unfamiliar with the power tool or these instructions to operate the power tool.

Power tools are dangerous in the hands of untrained users.

e) Maintain power tools and accessories. Check for misalignment or binding of moving parts, breakage of parts and any other condition that may affect the power tool's operation. If damaged, have the power tool repaired before use. *Many accidents are caused by poorly maintained power tools.*

f) Keep cutting tools sharp and clean. *Properly maintained cutting tools with sharp cutting edges are less likely to bind and are easier to control.*

g) Use the power tool, accessories and tool bits etc. in accordance with these instructions, taking into account the working conditions and the work to be performed. *Use of the power tool for operations different from those intended could result in a hazardous situation.*

h) Keep handles and grasping surfaces dry, clean and free from oil and grease. *Slippery handles and grasping surfaces do not allow for safe handling and control of the tool in unexpected situations.*

5) Battery tool use and care

a) Recharge only with the charger specified by the manufacturer. *A charger that is suitable for one type of battery pack may create a risk of fire when used with another battery pack.*

b) Use power tools only with specifically designated battery packs. *Use of any other battery packs may create a risk of injury and fire.*

c) When battery pack is not in use, keep it away from other metal objects, like paper clips, coins, keys, nails, screws or other small metal objects, that can make a connection from one terminal to another. *Shorting the battery terminals together may cause burns or a fire.*

d) **Under abusive conditions, liquid may be ejected from the battery; avoid contact. If contact accidentally occurs, flush with water. If liquid contacts eyes, additionally seek medical help. Liquid ejected from the battery may cause irritation or burns.**

e) **Do not use a battery pack or tool that is damaged or modified. Damaged or modified batteries may exhibit unpredictable behaviour resulting in fire, explosion or risk of injury.**

f) **Do not expose a battery pack or tool to fire or excessive temperature. Exposure to fire or temperature above 130 °C may cause explosion.**

g) **Follow all charging instructions and do not charge the battery pack or tool outside the temperature range specified in the instructions. Charging improperly or at temperatures outside the specified range may damage the battery and increase the risk of fire.**

6) Service

a) **Have your power tool serviced by a qualified repair person using only identical replacement parts. This will ensure that the safety of the power tool is maintained.**

b) **Never service damaged battery packs. Service of battery packs should only be performed by the manufacturer or authorized service providers.**

Drill safety warnings

1) Safety instructions for all operations

a) **Wear ear protectors when drilling. Exposure to noise can cause hearing loss.**

b) **Brace the tool properly before use. This tool produces a high output torque and without properly bracing the tool during operation, loss of control may occur resulting in personal injury.**

c) **Hold the power tool by insulated gripping surfaces, when performing an operation where the cutting accessory or fasteners may contact hidden wiring. Cutting accessory contacting a "live" wire may make exposed metal parts of the power tool "live" and could give the operator an electric shock.**

2) Safety instructions when using long drill bits

a) **Never operate at higher speed than the maximum speed rating of the drill bit. At higher speeds, the bit is likely to bend if allowed to rotate freely without contacting the workpiece, resulting in personal injury.**

b) **Always start drilling at low speed and with the bit tip in contact with the workpiece. At higher speeds, the bit is likely to bend if allowed to rotate freely without contacting the workpiece, resulting in personal injury.**

c) **Apply pressure only in direct line with the bit and do not apply excessive pressure. Bits can bend causing breakage or loss of control, resulting in personal injury.**

6. SCREWDRIVER SAFETY WARNING

Hold the power tool by insulated gripping surfaces, when performing an operation where the fastener may contact hidden wiring. Fasteners contacting a "live" wire may make exposed metal parts of the power tool "live" and could give the operator an electric shock.

7. ADDITIONAL SAFETY WARNINGS

- Protect the battery charger from rain and moisture. The penetration of water in a battery charger increases the risk of electric shock.
- Recharge only with the charger specified by the manufacturer. A charger that is suitable for one type of battery may create a risk of fire when used with another battery.
- Do not charge other batteries. The battery charger is suitable only for charging our lithium ion batteries within the listed voltage range. Otherwise there is danger of fire and explosion.
- Keep the battery charger clean. Contamination may cause the danger of electric shock.
- Check the battery charger, cable and plug each time before using. Do not use the battery charger when defects are detected. Do not open the battery charger yourself and have it repaired only by qualified personnel using original spare parts. Damaged battery chargers, cables and plugs increase the risk of electric shock.
- Do not operate the battery charger on easily inflammable surfaces (e. g. paper, textiles, etc.) or in combustible environments. There is danger of fire due to the heating of the battery charger during charging.
- Under abusive conditions, liquid may be ejected from the battery; avoid contact. If contact accidentally occurs, flush with water. If liquid contacts eyes, additionally seek medical help. Liquid ejected from the battery may cause irritation or burns.
- Do not open the battery yourself. There is danger of a short circuit.
- Protect the battery against heat, e.g., including against continuous sun irradiation and fire. There is a danger of explosion.
- Do not short-circuit the battery. There is a danger of explosion.
- In case of damage and improper use of the battery, vapors may be emitted. In case of accidents, provide for fresh air and consult a physician. The vapors can irritate the respiratory system.

7.1 Special safety instructions for battery and charger

7.2 If under extreme conditions any electrolyte should escape from the battery, it's essential to avoid contact with skin. If electrolyte does come into contact with your skin, rinse it off with water. In the event of electrolyte contact with your eyes, it's essential to consult a doctor.

This charger can be used by children aged from 8 years and above and persons with reduced physical, sensory or mental capabilities or lack of experience and knowledge if they have been given supervision or instruction concerning use of the appliance in a safe way and understand the hazards involved. Children shall not play with the appliance. Cleaning and user maintenance shall not be made by children without supervision.

- Before the use of the charger and the battery read the instruction manual carefully.
- During the charge process, the current used should correspond to the current of the battery charger.
- Never let moisture, rain or splashed water reaches the charging location.
- The ambient temperature must not exceed 40 °C.

- Batteries which are defective or damaged or can no longer be recharged must be disposed as a hazardous waste. Hand them over at a special collection point. Never harm our environment. Do not throw unusable storage-battery packet away into the domestic waste, into fire or into water.

If the supply cord of the charger is damaged, it must be replaced by the manufacturer, its service agent or similarly qualified persons in order to avoid a hazard.

Use only storage-battery packet, which have been produced by the original manufacturer.

- Always keep the surface of the charger free from dust and dirt.

Insert the battery packet into the charger. Follow the guidelines provided concerning polarity.

- Always remove battery packet before working on the machine

- When the battery is outside the drill, cover the contacts to avoid short circuits (e.g. from tools)

- Do not throw batteries into water or fire, risk of explosion!

- Protect the battery from impacts, and don't open it.
- Never discharge the battery completely and recharge occasionally if not used for a prolonged period

WARNING: Do not recharge non-rechargeable batteries.

7.2 Residual risks

Even when the tool is used as prescribed it is not possible to eliminate all residual risk factors.

The following hazards may arise in connection with the tool's construction and design:

- Damage to lungs if an effective dust mask is not worn.
- Damage to hearing if effective hearing protection is not worn.
- Health defects resulting from vibration emission if the power tool is being used over longer period of time or not adequately managed and properly maintained.



WARNING! This machine produces an electromagnetic field during operation. This field may under some circumstances interfere with active or passive medical implants. To reduce the risk of serious or fatal injury, we recommend persons with medical implants to consult their physician and the medical implant manufacturer before operating this machine.

8. OPERATION

8.1 Charging the battery

The battery (5) must be charged before first use. Only after several charge and discharge cycles the battery will attain full capacity.

Only use the provided adaptor (10) to charge the battery set.

Only charge the battery set when the ambient temperature is within 10° - 40 °C.

Plug the adaptor (10) to a 230 V alternating voltage source.

The battery (5) should under no circumstances be disassembled.

To remove the battery, press the battery release button (6) on the top side of the battery set and extract the battery (5).

Connect the plug of the charger to the loading-socket (9) of the battery-set.

Red LED will light once the battery has been connected to the charger and the charging procedure will proceed.

The battery set is completely loaded and ready for use once the green LED is lit and the red LED is OFF – after approximately 1-1.5 hour(fast charger) or 3-5 hours (slow charger).

8.2 Positioning and removing a drill or screw bit

This tool is equipped with a keyless chuck.

- Open the chuck by turning the collar.
- Insert the drill or screw bit in the chuck.
- Close the chuck by firmly tightening the front collar (a) while holding the rear part (b) of the chuck with the other hand.
- In order to remove the drill or screw bit proceed in reverse order. Before positioning or removing a drill or screw bit always remove the battery from the machine.

8.3 Forward/reverse switch

- Push the forward/reverse switch (2) from right to left side to drill holes and fasten screws.
- Push the forward/reverse switch (2) from left to right side to loosen screws. Always wait until the motor has come to a complete standstill before changing the direction of rotation.

8.4 Adjusting the torque

This machine has been fitted with an adjustable coupling (18+1 pos.) to limit the torque when tightening screws.

- Turn the adjustment collar (3) clockwise to reduce the torque and counterclockwise to increase the torque. The correct setting depends on the type and size of the screw and the work piece.
- In case of doubt, start with the lowest setting and increase the torque until you have reached the desired result.
- For drilling, turn the adjustment collar fully counterclockwise (to the drilling symbol).

8.5 Switching on and off

- Push the forward/reverse switch (2) on the left side or on the right side.
- To switch on the machine, press the on/off switch (1).

▪To switch off the machine, release the on/off switch.

8.6 Variable speed

▪Applying more pressure to the On/Off switch will increase the speed.

▪Applying less pressure to the On/Off switch will decrease the speed.

8.7 Lower/higher speed selecting

▪Lower speed: switch Speed convert button to position “1”.

▪Higher speed: switch Speed convert button to position “2”.

9. CLEANING AND MAINTENANCE



Attention! Before performing any work on the equipment, pull the power plug.

9.1 Cleaning

Keep the ventilation slots of the machine clean to prevent overheating of the engine.

Regularly clean the machine housing with a soft cloth, preferably after each use.

Keep the ventilation slots free from dust and dirt.

If the dirt does not come off use a soft cloth moistened with soapy water.



Never use solvents such as petrol, alcohol, ammonia water, etc. These solvents may damage the plastic parts.

10. TECHNICAL DATA

Model nr.	HPP18V2B2A
Rated voltage	20Vd.c.
No – load speed	0-400 / 0-1400min ⁻¹
Torque positions	18+2
Max. drill capacity steel	Ø10mm
Charger	HPP18V2B2A Input: 100-240~,50/60Hz, 0.8A, output: 21.5V d.c., 1.5A

Battery	HPP18V2B2A 18V d.c.(20V max).,2000 mAh with 5 Li-ion cells
Charger time	1.5 hour
Max. torque	30 Nm
Chuck type	Keyless chuck
Acoustic pressure level LpA	87.6 dB(A), K=5dB(A)
Acoustic power level LwA	98.6dB(A), K=5dB(A)
Vibration	ah,D=1.298m/s ² K =1,5 m/s ² ah,ID=11,505m/s ² K=1,5m/s ²

11. NOISE

Noise emission values measured according to relevant standard.



ATTENTION! Wear hearing protection when sound pressure is over 85 dB(A).

Information:

- The declared vibration total value has been measured in accordance with a standard test method and may be used for comparing one tool with another;
- The declared vibration total value may also be used in a preliminary assessment of exposure.

Warning:

- The vibration emission during actual use of the power tool can differ from the declared total value depending on the ways in which the tool is used;
- need to identify safety measures to protect the operator that are based on an estimation of exposure in the actual conditions of use (taking account of all parts of the operating cycle such as the times when the tool is switched off and when it is running idle in addition to the trigger time).

12. STORAGE

Thoroughly clean the whole machine and its accessories.

Store it out of the reach of children, in a stable and secure position, in a cool and dry place, avoid too high and too low temperatures.

Protect it from exposure to direct sunlight. Keep it in the dark, if possible.

Don't keep it in plastic bags to avoid humidity build-up.

13. ENVIRONMENT



Should your appliance need replacement after extended use, do not dispose of it with the household refuse, but in an environmentally safe way. Waste produced by electrical machine items should not be handled like normal household rubbish. Please recycle where recycle facilities exist. Check with your Local Authority or retailer for recycling advice.

14. BATTERY PACK

This product contains Li-ion. To preserve natural resources, please recycle or dispose of batteries properly. Local, state or federal laws may prohibit disposal of Li-ion batteries in ordinary trash. Consult your local waste authority for information regarding available recycling and/or disposal options.

15. DECLARATION OF CONFORMITY



BUILDER SAS

ZI, 32 rue Aristide Bergès – 31270 Cugnaux – France

Declares that the machinery designated below:

Drill / Screwdriver

HPP18V2B2A

S/N: 20210531481-20210531984

is in conformity with the essential requirements and other relevant provisions of the applicable European Directives, based on the application of European harmonized standards. Any unauthorized modification of the apparatus voids this declaration.

European Directives (including, if applicable, their amendments up to the date of signature);

2011/65/EU+(EU) 2015/863; 2006/42/EC; 2014/30/EU

European harmonized standards (including, if applicable, their amendments up to the date of signature);

EN 62841-1: 2015; EN 62841-2-1:2018

EN55014-1: 2017; EN55014-2 : 2015

EN 60335-1 : 2012+A11+A13+A1+A14+A2

EN 60335-2-29 : 2004+A2+A11

EN 62233 : 2008

EN 55014-1:2017 TESTING LE

EN IEC 61000-3-2:2019 TESTING

EN 61000-3-3:2013/A1:2019 TESTING LE

EN 55014-2:2015 TESTING LE

EN IEC 61000-6-1:2019 TESTING

EN 61000-6-3:2007+A1:2011

Cugnaux, le 24/01/2021

Phillipe MARIE / PDG

Responsible of technical file: M. Olivier Patriarca

16. WARRANTY

HYUNDAI

WARRANTY

The manufacturer guarantees the product against defects in material and workmanship for a period of 2 years from the date of the original purchase. The warranty only applies if the product is for household use. The warranty does not cover breakdowns due to normal wear and tear.

The manufacturer agrees to replace parts identified as defective by the designated distributor. The manufacturer does not accept responsibility for the replacement of the machine, in whole or in part, and/or ensuing damage.

The warranty does not cover breakdowns due to:

- insufficient maintenance.
- abnormal assembly, adjustment or operations of the product.
- parts subject to normal wear and tear.

The warranty does not extend to:

- shipping and packaging costs.
- using the tool for a purpose other than that for which it was designed.
- the use and maintenance of the machine done in a manner not described in the user manual.

Due to our policy of continuous product improvement, we reserve the right to alter or change specifications without notice. Consequently, the product may be different from the information contained therein, but a modification will be undertaken without notice if it is recognized as an improvement of the preceding characteristic.

READ THE MANUAL CAREFULLY BEFORE USING THE MACHINE.

When ordering spare parts, please indicate the part number or code, you can find this in the spare parts list in this manual. Keep the purchase receipt; without it, the warranty is invalid. To help you with your product, we invite you to contact us by phone or via our website:

- **+33 (0)9.70.75.30.30**
- **<https://services.swap-europe.com/contact>**

You must create a "ticket" via the web platform.

- Register or create your account.
- Indicate the reference of the tool.
- Choose the subject of your request.
- Describe your problem.
- Attach these files: invoice or sales receipt, photo of the identification plate (serial number), photo of the part you need (for example: pins on the transformer plug which are broken).



17. PRODUCT FAILURE

WHAT TO DO IF MY MACHINE BREAKS DOWN?

If you bought your product in a store:

- a) Empty the fuel tank if your product has one.
- b) Make sure that your machine is complete with all accessories supplied, and clean! If this is not the case, the repairer will refuse the machine.

Go to the store with the complete machine and with the receipt or invoice.

If you bought your product on a website:

- a) Empty the fuel tank if your product has one.
- b) Make sure that your machine is complete with all accessories supplied, and clean! If this is not the case, the repairer will refuse the machine.
- c) Create a SWAP-Europe service ticket on the site: <https://services.swap-europe.com> When making the request on SWAP-Europe, you must attach the invoice and the photo of the nameplate (serial number).
- d) Contact the repair station to make sure it is available before dropping off the machine.

Go to the repair station with the complete machine packed, accompanied by the purchase invoice and the station support sheet downloadable after the service request is completed on the SWAP-Europe site

For machines with engine failure from manufacturers BRIGGS & STRATTON, HONDA and RATO, please refer to the following instructions.

Repairs will be done by approved engine manufacturers of these manufacturers, see their site:

- <http://www.briggsandstratton.com/eu/fr>
- <http://www.honda-engines-eu.com/fr/service-network-page;jsessionid=5EE8456CF39CD572AA2AEEDFD290CDAE>
- <https://www.rato-europe.com/it/service-network>

Please keep your original packaging to allow for after-sales service returns or pack your machine with a similar cardboard box of the same dimensions.

For any question concerning our after-sales service you can make a request on our website <https://services.swap-europe.com>

Our hotline remains available at +33 (9) 70 75 30 30.



18. WARRANTY EXCLUSIONS

THE WARRANTY DOES NOT COVER:

- Start-up and setting up of the product.
- Damage resulting from normal wear and tear of the product.
- Damage resulting from improper use of the product.
- Damage resulting from assembly or start-up not in accordance with the user manual.
- Breakdowns related to carburetion beyond 90 days and fouling of carburetors.
- Periodic and standard maintenance events.
- Actions of modification and dismantling that directly void the warranty.
- Products whose original authentication marking (brand, serial number) has been degraded, altered or withdrawn.
- Replacement of consumables.
- The use of non-original parts.
- Breakage of parts following impacts or projections.
- Accessories breakdowns.
- Defects and their consequences linked to any external cause.
- Loss of components and loss due to insufficient screwing.
- Cutting components and any damage related to the loosening of parts.
- Overload or overheating.
- Poor power supply quality: faulty voltage, voltage error, etc.
- Damages resulting from the deprivation of enjoyment of the product during the time necessary for repairs and more generally the costs related to the immobilization of the product.
- The costs of a second opinion established by a third party following an estimate by a SWAP-Europe repair station
- The use of a product which would show a defect or a breakage which was not the subject of an immediate report and/or repair with the services of SWAP-Europe.
- Deterioration linked to transport and storage*.
- Launchers beyond 90 days.
- Oil, petrol, grease.
- Damages related to the use of non-compliant fuels or lubricants.

* In accordance with transport legislation, damage related to transport must be declared to carriers within 48 hours maximum after observation by registered letter with acknowledgement of receipt.

This document is a supplement to your notice, a non-exhaustive list.

Attention: all orders must be checked in the presence of the delivery person. In case of refusal by the delivery person, it you must simply refuse the delivery and notify your refusal.

Reminder: the reserves do not exclude the notification by registered letter with acknowledgement within 72 hours.

Information:

Thermal devices must be wintered each season (service available on the SWAP-Europe site). Batteries must be charged before being stored.

HYUNDAI
POWER PRODUCTS

For Inquiries, please contact:

BUILDER SAS

32, rue Aristide Bergès Z1 31270 Cugnaux, France

Tél. : +33 (0) 5.34.502.502 Fax : +33 (0) 5.34.502.503

<http://www.hyundaipower-fr.com/>

Fabriqué en République Populaire de Chine (PRC)